

| | | | |
|-------|----|------|------|
| | 1: | 10.0 | ↗ |
| Serie | | | 10.0 |
| Total | | | 0.0 |

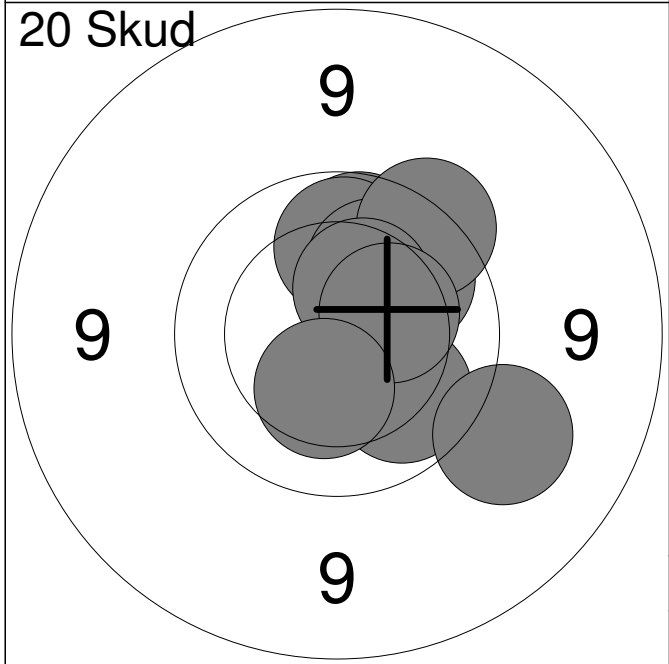

| | | | |
|-------|-----|------|------|
| | 1: | 9.9 | ↗ |
| | 2: | 10.0 | ↗ |
| | 3: | 10.0 | ↗ |
| | 4: | 10.1 | ↗ |
| | 5: | 10.0 | ↘ |
| | 6: | 9.7 | ↗ |
| | 7: | 10.4 | ↗ |
| | 8: | 10.3 | → |
| | 9: | 10.3 | ↘ |
| | 10: | 9.3 | ↘ |
| Serie | | | 97.0 |
| Total | | | 97.0 |

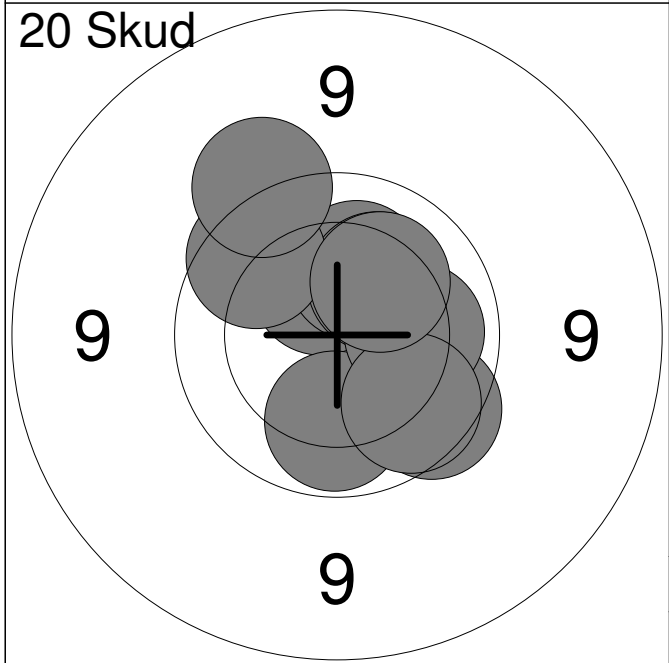

| | | | |
|-------|-----|------|-------|
| | 11: | 9.8 | ↘ |
| | 12: | 10.4 | ↗ |
| | 13: | 10.2 | ↗ |
| | 14: | 10.0 | ↘ |
| | 15: | 10.2 | ↗ |
| | 16: | 10.1 | → |
| | 17: | 9.9 | ↘ |
| | 18: | 9.8 | ↗ |
| | 19: | 9.5 | ↗ |
| | 20: | 10.2 | ↗ |
| Serie | | | 96.0 |
| Total | | | 193.0 |

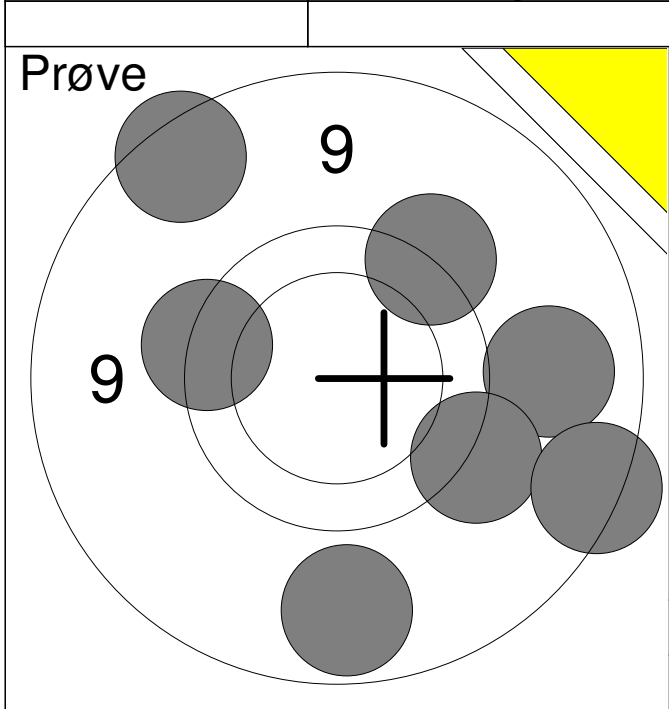

| | | |
|--------------|-----|-------------|
| 1: | 9.1 | → |
| 2: | 8.8 | ↗ |
| 3: | 9.5 | ↘ |
| 4: | 9.5 | ↗ |
| 5: | 8.8 | ↘ |
| 6: | 9.6 | ↗ |
| 7: | 9.0 | ↓ |
| Serie | | 61.0 |
| Total | | 0.0 |

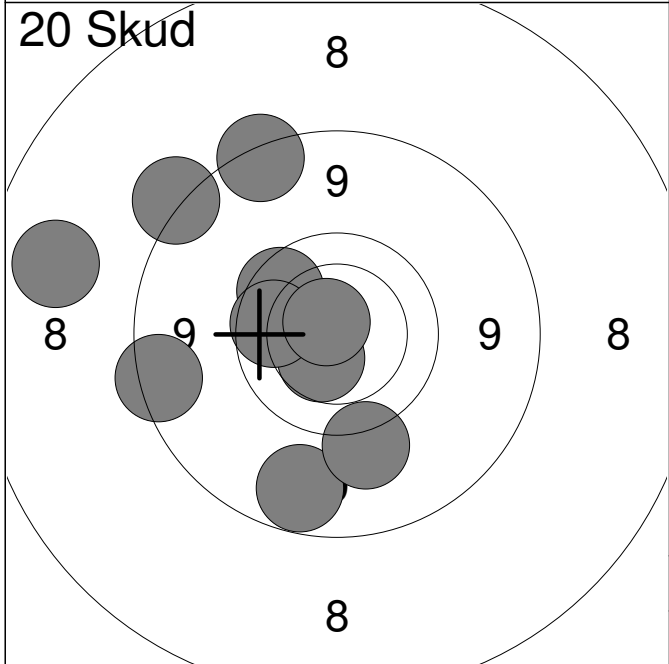

| | | |
|--------------|-------|-------------|
| 1: | 9.8 | ↗ |
| 2: | 10.4 | ↘ |
| 3: | 8.1 | ↗ |
| 4: | 8.6 | ↗ |
| 5: | 8.7 | ↗ |
| 6: | 9.0 | ↘ |
| 7: | 9.9 | ↗ |
| 8: | *10.7 | ↗ |
| 9: | 9.4 | ↘ |
| 10: | 8.8 | ↖ |
| Serie | | 88.0 |
| Total | | 88.0 |

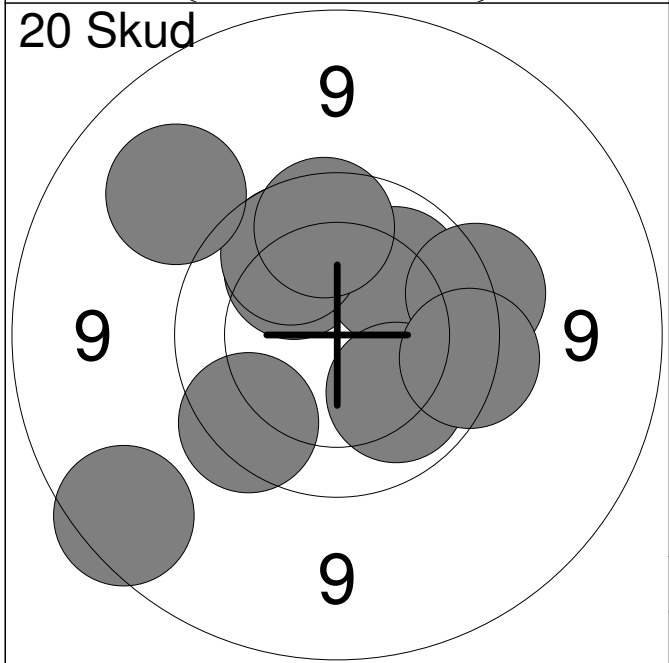

| | | |
|--------------|------|--------------|
| 11: | 10.1 | ↗ |
| 12: | 10.1 | ↗ |
| 13: | 8.9 | ↖ |
| 14: | 10.0 | ↗ |
| 15: | 9.6 | → |
| 16: | 10.1 | ↘ |
| 17: | 9.7 | → |
| 18: | 9.2 | ↗ |
| 19: | 9.9 | ↗ |
| 20: | 9.8 | ↖ |
| Serie | | 93.0 |
| Total | | 181.0 |

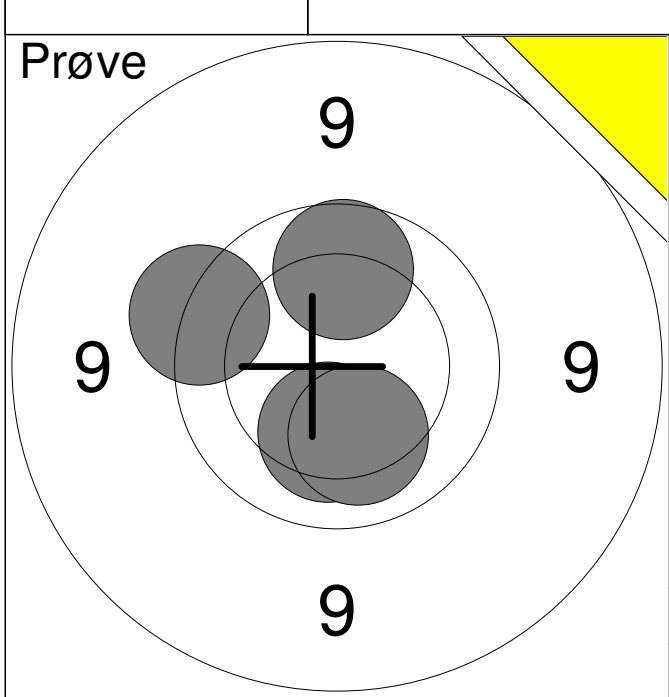

| | | |
|--------------|------|-------------|
| 1: | 9.9 | ↑ |
| 2: | 9.6 | ↖ |
| 3: | 10.2 | ↓ |
| 4: | 10.2 | ↓ |
| Serie | | 38.0 |
| Total | | 0.0 |

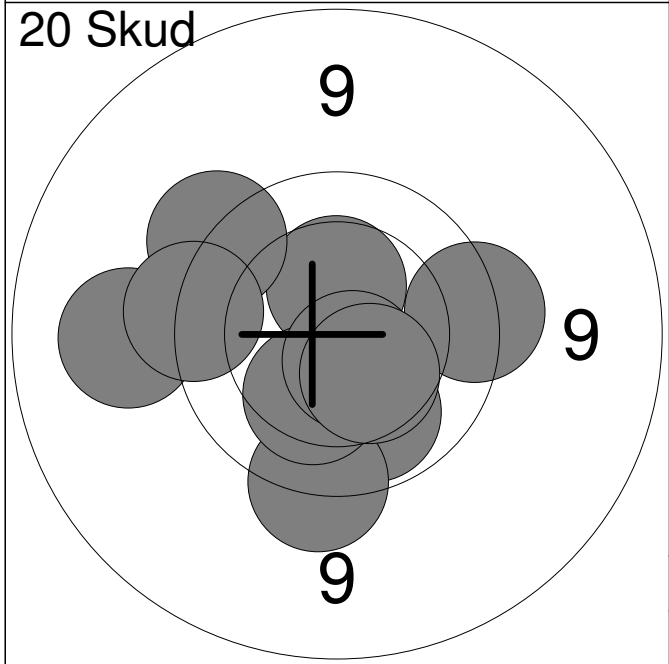

| | | |
|--------------|-------|-------------|
| 1: | 10.4 | ↑ |
| 2: | 10.0 | ↘ |
| 3: | 9.7 | → |
| 4: | 9.6 | ↗ |
| 5: | 9.2 | ← |
| 6: | 9.6 | ↓ |
| 7: | 10.2 | ↙ |
| 8: | *10.6 | ↘ |
| 9: | 10.4 | ↘ |
| 10: | 9.6 | ← |
| Serie | | 95.0 |
| Total | | 95.0 |

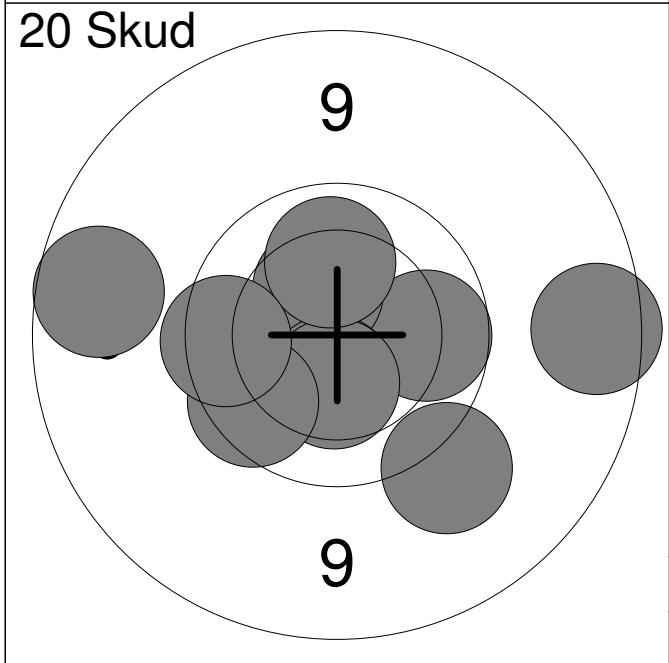

| | | |
|--------------|------|--------------|
| 11: | 9.9 | → |
| 12: | 9.4 | ↘ |
| 13: | 10.4 | ↗ |
| 14: | 10.4 | ↙ |
| 15: | 8.9 | → |
| 16: | 8.9 | ← |
| 17: | 10.4 | ↓ |
| 18: | 10.1 | ↑ |
| 19: | 9.8 | ↖ |
| 20: | 9.8 | ← |
| Serie | | 92.0 |
| Total | | 187.0 |

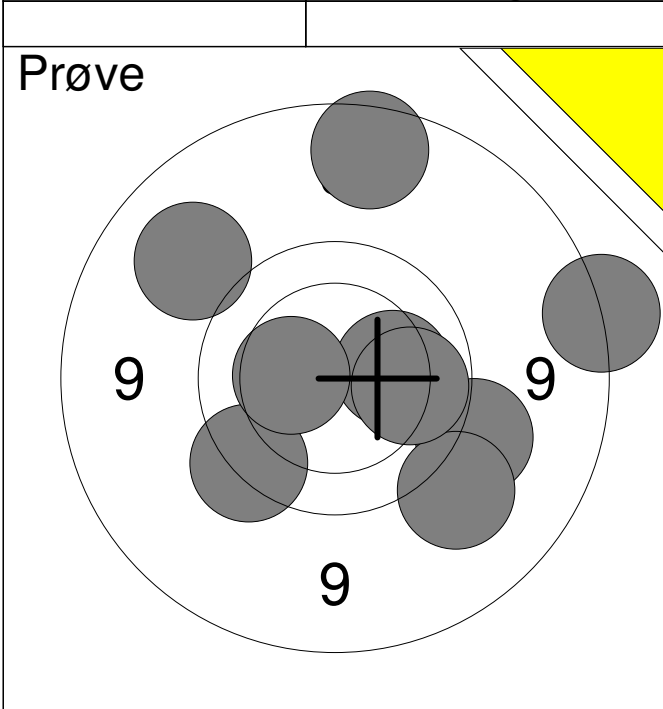

| | | |
|--------------|------|-------------|
| 1: | 10.2 | → |
| 2: | 8.7 | → |
| 3: | 9.6 | ↙ |
| 4: | 9.4 | → |
| 5: | 9.2 | ↗ |
| 6: | 9.3 | ↘ |
| 7: | 8.9 | ↑ |
| 8: | 10.4 | ← |
| 9: | 10.0 | → |
| Serie | | 82.0 |
| Total | | 0.0 |

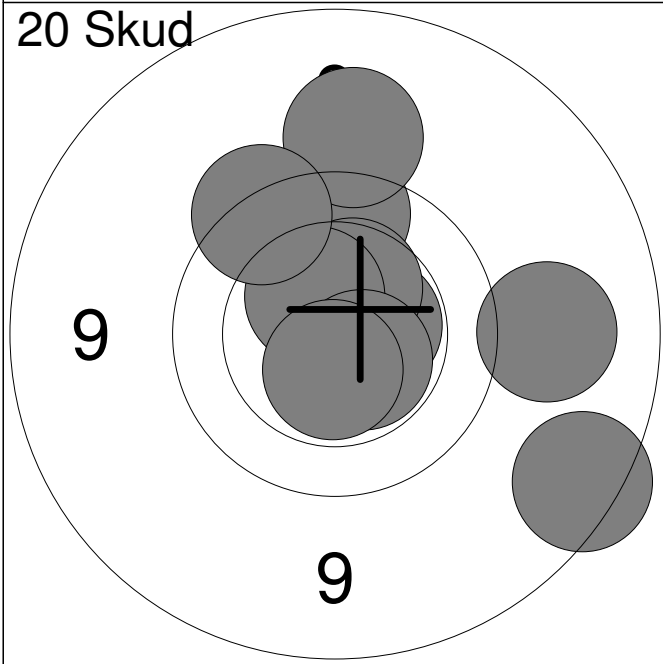

| | | |
|--------------|-------|-------------|
| 1: | *10.5 | → |
| 2: | 9.8 | ↑ |
| 3: | 10.4 | ↗ |
| 4: | 10.5 | ↗ |
| 5: | *10.5 | ↘ |
| 6: | 9.3 | ↑ |
| 7: | 9.7 | ↗ |
| 8: | 9.2 | → |
| 9: | *10.6 | ↓ |
| 10: | 8.8 | ↘ |
| Serie | | 94.0 |
| Total | | 94.0 |

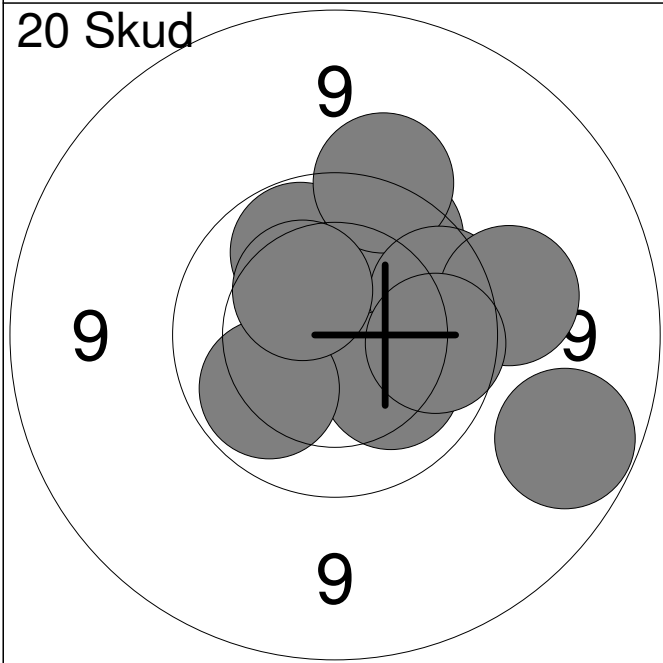

| | | |
|--------------|------|--------------|
| 11: | 10.0 | ↖ |
| 12: | 9.8 | ↗ |
| 13: | 9.5 | ↗ |
| 14: | 9.8 | → |
| 15: | 9.4 | → |
| 16: | 10.2 | ↘ |
| 17: | 10.0 | ↙ |
| 18: | 10.4 | ↗ |
| 19: | 9.0 | ↘ |
| 20: | 9.9 | → |
| Serie | | 94.0 |
| Total | | 188.0 |

| | | | | | | | | | | | | | | | | | | | | |
|---------------------|--|----|-----|---|----|-----|---|----|-------|---|----|-------|---|----|-------|---|-------|------|-------|-----|
| <p>Prøve</p> | <table style="width:100%; border-collapse: collapse;"> <tr><td style="width:10%;">1:</td><td style="width:15%;">8.5</td><td style="width:10%; text-align: right;">↙</td></tr> <tr><td>2:</td><td>9.9</td><td style="text-align: right;">↙</td></tr> <tr><td>3:</td><td>*10.6</td><td style="text-align: right;">↑</td></tr> <tr><td>4:</td><td>*10.7</td><td style="text-align: right;">↙</td></tr> <tr><td>5:</td><td>*10.9</td><td style="text-align: right;">→</td></tr> </table> <table border="1" style="width:100%; border-collapse: collapse; margin-top: 5px;"> <tr> <td style="width:80%;">Serie</td> <td style="text-align: right;">47.0</td> </tr> <tr> <td>Total</td> <td style="text-align: right;">0.0</td> </tr> </table> | 1: | 8.5 | ↙ | 2: | 9.9 | ↙ | 3: | *10.6 | ↑ | 4: | *10.7 | ↙ | 5: | *10.9 | → | Serie | 47.0 | Total | 0.0 |
| 1: | 8.5 | ↙ | | | | | | | | | | | | | | | | | | |
| 2: | 9.9 | ↙ | | | | | | | | | | | | | | | | | | |
| 3: | *10.6 | ↑ | | | | | | | | | | | | | | | | | | |
| 4: | *10.7 | ↙ | | | | | | | | | | | | | | | | | | |
| 5: | *10.9 | → | | | | | | | | | | | | | | | | | | |
| Serie | 47.0 | | | | | | | | | | | | | | | | | | | |
| Total | 0.0 | | | | | | | | | | | | | | | | | | | |

| | | | | | | | | | | | | | | | | | | | | | | | | | | | | | | | | | | | |
|-----------------------|---|----|-----|---|----|-----|---|----|------|---|----|-------|---|----|-------|---|----|------|---|----|------|---|----|------|---|----|------|---|-----|-------|---|-------|------|-------|------|
| <p>20 Skud</p> | <table style="width:100%; border-collapse: collapse;"> <tr><td style="width:10%;">1:</td><td style="width:15%;">9.9</td><td style="width:10%; text-align: right;">↙</td></tr> <tr><td>2:</td><td>9.8</td><td style="text-align: right;">↙</td></tr> <tr><td>3:</td><td>10.3</td><td style="text-align: right;">→</td></tr> <tr><td>4:</td><td>*10.8</td><td style="text-align: right;">↗</td></tr> <tr><td>5:</td><td>*10.7</td><td style="text-align: right;">↗</td></tr> <tr><td>6:</td><td>10.4</td><td style="text-align: right;">↙</td></tr> <tr><td>7:</td><td>10.3</td><td style="text-align: right;">↙</td></tr> <tr><td>8:</td><td>10.5</td><td style="text-align: right;">↙</td></tr> <tr><td>9:</td><td>10.3</td><td style="text-align: right;">→</td></tr> <tr><td>10:</td><td>*10.7</td><td style="text-align: right;">↙</td></tr> </table> <table border="1" style="width:100%; border-collapse: collapse; margin-top: 5px;"> <tr> <td style="width:80%;">Serie</td> <td style="text-align: right;">98.0</td> </tr> <tr> <td>Total</td> <td style="text-align: right;">98.0</td> </tr> </table> | 1: | 9.9 | ↙ | 2: | 9.8 | ↙ | 3: | 10.3 | → | 4: | *10.8 | ↗ | 5: | *10.7 | ↗ | 6: | 10.4 | ↙ | 7: | 10.3 | ↙ | 8: | 10.5 | ↙ | 9: | 10.3 | → | 10: | *10.7 | ↙ | Serie | 98.0 | Total | 98.0 |
| 1: | 9.9 | ↙ | | | | | | | | | | | | | | | | | | | | | | | | | | | | | | | | | |
| 2: | 9.8 | ↙ | | | | | | | | | | | | | | | | | | | | | | | | | | | | | | | | | |
| 3: | 10.3 | → | | | | | | | | | | | | | | | | | | | | | | | | | | | | | | | | | |
| 4: | *10.8 | ↗ | | | | | | | | | | | | | | | | | | | | | | | | | | | | | | | | | |
| 5: | *10.7 | ↗ | | | | | | | | | | | | | | | | | | | | | | | | | | | | | | | | | |
| 6: | 10.4 | ↙ | | | | | | | | | | | | | | | | | | | | | | | | | | | | | | | | | |
| 7: | 10.3 | ↙ | | | | | | | | | | | | | | | | | | | | | | | | | | | | | | | | | |
| 8: | 10.5 | ↙ | | | | | | | | | | | | | | | | | | | | | | | | | | | | | | | | | |
| 9: | 10.3 | → | | | | | | | | | | | | | | | | | | | | | | | | | | | | | | | | | |
| 10: | *10.7 | ↙ | | | | | | | | | | | | | | | | | | | | | | | | | | | | | | | | | |
| Serie | 98.0 | | | | | | | | | | | | | | | | | | | | | | | | | | | | | | | | | | |
| Total | 98.0 | | | | | | | | | | | | | | | | | | | | | | | | | | | | | | | | | | |

| | | | | | | | | | | | | | | | | | | | | | | | | | | | | | | | | | | | |
|-----------------------|---|-----|------|---|-----|-------|---|-----|-------|---|-----|-------|---|-----|------|---|-----|------|---|-----|-------|---|-----|-------|---|-----|-------|---|-----|------|---|-------|-------|-------|-------|
| <p>20 Skud</p> | <table style="width:100%; border-collapse: collapse;"> <tr><td style="width:10%;">11:</td><td style="width:15%;">10.4</td><td style="width:10%; text-align: right;">→</td></tr> <tr><td>12:</td><td>*10.7</td><td style="text-align: right;">↙</td></tr> <tr><td>13:</td><td>*10.8</td><td style="text-align: right;">↓</td></tr> <tr><td>14:</td><td>*10.6</td><td style="text-align: right;">↙</td></tr> <tr><td>15:</td><td>10.1</td><td style="text-align: right;">→</td></tr> <tr><td>16:</td><td>10.2</td><td style="text-align: right;">↙</td></tr> <tr><td>17:</td><td>*10.9</td><td style="text-align: right;">↓</td></tr> <tr><td>18:</td><td>*10.8</td><td style="text-align: right;">↓</td></tr> <tr><td>19:</td><td>*10.5</td><td style="text-align: right;">↑</td></tr> <tr><td>20:</td><td>10.5</td><td style="text-align: right;">↗</td></tr> </table> <table border="1" style="width:100%; border-collapse: collapse; margin-top: 5px;"> <tr> <td style="width:80%;">Serie</td> <td style="text-align: right;">100.0</td> </tr> <tr> <td>Total</td> <td style="text-align: right;">198.0</td> </tr> </table> | 11: | 10.4 | → | 12: | *10.7 | ↙ | 13: | *10.8 | ↓ | 14: | *10.6 | ↙ | 15: | 10.1 | → | 16: | 10.2 | ↙ | 17: | *10.9 | ↓ | 18: | *10.8 | ↓ | 19: | *10.5 | ↑ | 20: | 10.5 | ↗ | Serie | 100.0 | Total | 198.0 |
| 11: | 10.4 | → | | | | | | | | | | | | | | | | | | | | | | | | | | | | | | | | | |
| 12: | *10.7 | ↙ | | | | | | | | | | | | | | | | | | | | | | | | | | | | | | | | | |
| 13: | *10.8 | ↓ | | | | | | | | | | | | | | | | | | | | | | | | | | | | | | | | | |
| 14: | *10.6 | ↙ | | | | | | | | | | | | | | | | | | | | | | | | | | | | | | | | | |
| 15: | 10.1 | → | | | | | | | | | | | | | | | | | | | | | | | | | | | | | | | | | |
| 16: | 10.2 | ↙ | | | | | | | | | | | | | | | | | | | | | | | | | | | | | | | | | |
| 17: | *10.9 | ↓ | | | | | | | | | | | | | | | | | | | | | | | | | | | | | | | | | |
| 18: | *10.8 | ↓ | | | | | | | | | | | | | | | | | | | | | | | | | | | | | | | | | |
| 19: | *10.5 | ↑ | | | | | | | | | | | | | | | | | | | | | | | | | | | | | | | | | |
| 20: | 10.5 | ↗ | | | | | | | | | | | | | | | | | | | | | | | | | | | | | | | | | |
| Serie | 100.0 | | | | | | | | | | | | | | | | | | | | | | | | | | | | | | | | | | |
| Total | 198.0 | | | | | | | | | | | | | | | | | | | | | | | | | | | | | | | | | | |

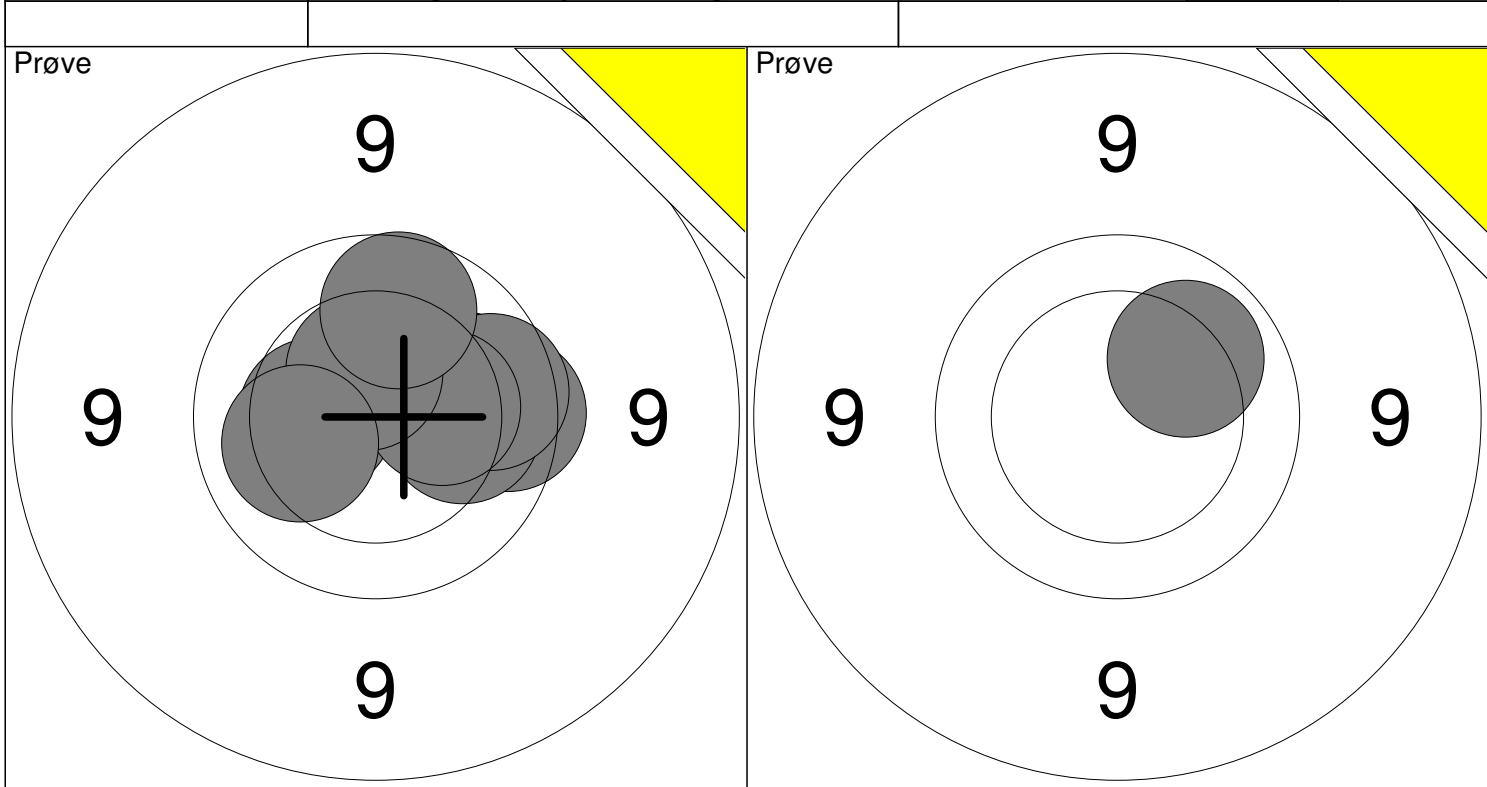

| | | | | | | |
|-----------|------------|-------|------|------------|-------|------|
| 1: 10.4 ↗ | 6: 9.9 → | Serie | 97.0 | 11: 10.1 ↗ | Serie | 10.0 |
| 2: 9.8 → | 7: 10.3 → | | | 11: 10.1 ↗ | | |
| 3: 10.1 → | 8: *10.5 ↑ | Total | 0.0 | | Total | 0.0 |
| 4: 10.1 → | 9: 9.9 ↑ | | | | | |
| 5: 10.4 ← | 10: 10.2 ← | | | | | |

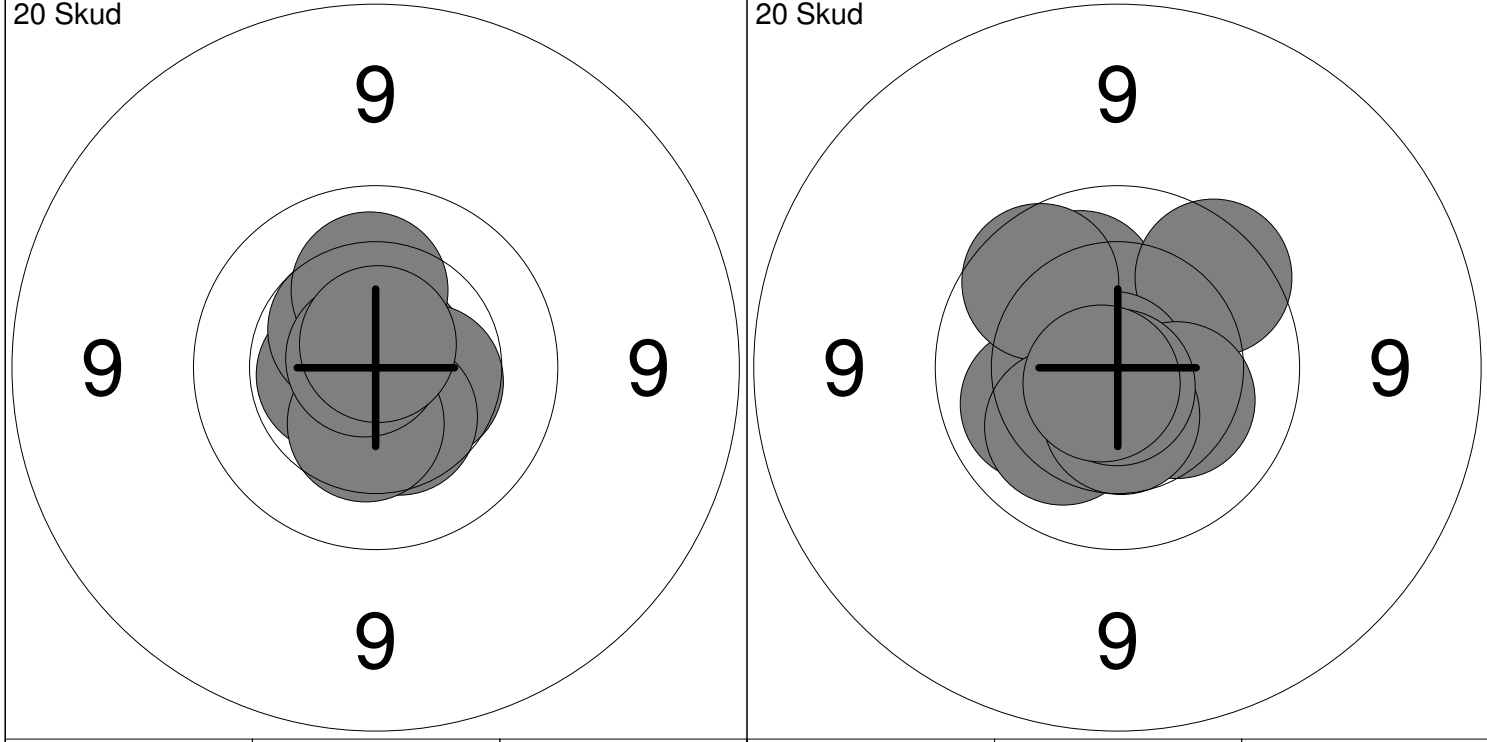

| | | | | | | | |
|------------|-------------|-------|-------|-------------|-------------|-------|-------|
| 1: *10.6 ← | 6: 10.2 ↑ | Serie | 100.0 | 11: 10.1 ↗ | 16: 10.3 → | Serie | 98.0 |
| 2: *10.9 → | 7: 10.4 ↓ | | | 11: 10.1 ↗ | 16: 10.3 → | | |
| 3: *10.8 ↗ | 8: 10.4 ↓ | Total | 100.0 | 12: 9.8 ↗ | 17: 10.2 ↘ | Total | 198.0 |
| 4: 10.5 → | 9: *10.8 ↖ | | | 12: 9.8 ↗ | 17: 10.2 ↘ | | |
| 5: 10.5 ↗ | 10: *10.7 ↑ | | | 13: *10.9 ← | 18: 10.5 ↓ | | |
| | | | | 14: 10.1 ← | 19: *10.8 ↓ | | |
| | | | | 15: 9.9 ↗ | 20: *10.7 ↘ | | |

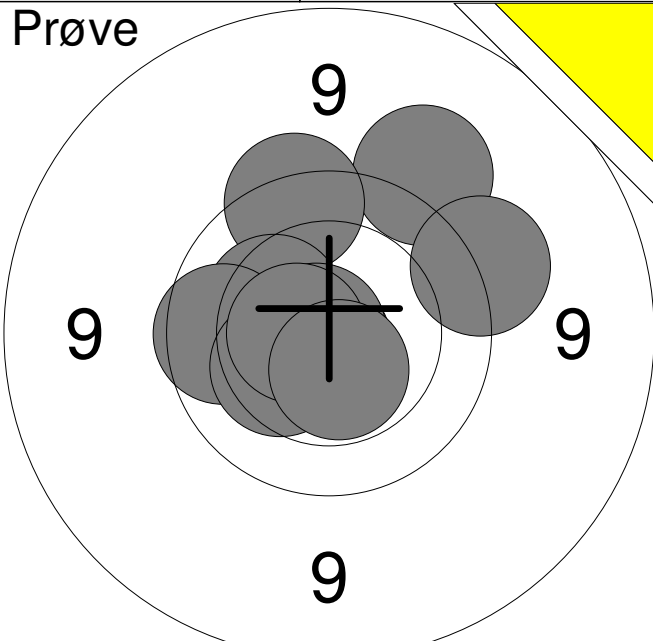
| | | | | | | | | | | | | | | | | | | | | | | | | | | | | | | | | | | | | | |
|--|--|------|-----|---|----|-----|---|----|-------|---|----|-----|---|----|------|---|----|-----|---|----|-------|---|----|------|---|----|-------|---|-----|-------|---|-------|--|------|-------|--|-----|
| <p>Prøve</p>  | <table style="width:100%; border-collapse: collapse;"> <tr><td>1:</td><td>9.4</td><td>↗</td></tr> <tr><td>2:</td><td>9.5</td><td>→</td></tr> <tr><td>3:</td><td>*10.8</td><td>↘</td></tr> <tr><td>4:</td><td>9.7</td><td>↑</td></tr> <tr><td>5:</td><td>10.3</td><td>↗</td></tr> <tr><td>6:</td><td>9.9</td><td>←</td></tr> <tr><td>7:</td><td>*10.8</td><td>←</td></tr> <tr><td>8:</td><td>10.3</td><td>↘</td></tr> <tr><td>9:</td><td>*10.6</td><td>←</td></tr> <tr><td>10:</td><td>*10.5</td><td>↘</td></tr> <tr style="border-top: 1px solid black;"><td colspan="2">Serie</td><td>96.0</td></tr> <tr><td colspan="2">Total</td><td>0.0</td></tr> </table> | 1: | 9.4 | ↗ | 2: | 9.5 | → | 3: | *10.8 | ↘ | 4: | 9.7 | ↑ | 5: | 10.3 | ↗ | 6: | 9.9 | ← | 7: | *10.8 | ← | 8: | 10.3 | ↘ | 9: | *10.6 | ← | 10: | *10.5 | ↘ | Serie | | 96.0 | Total | | 0.0 |
| 1: | 9.4 | ↗ | | | | | | | | | | | | | | | | | | | | | | | | | | | | | | | | | | | |
| 2: | 9.5 | → | | | | | | | | | | | | | | | | | | | | | | | | | | | | | | | | | | | |
| 3: | *10.8 | ↘ | | | | | | | | | | | | | | | | | | | | | | | | | | | | | | | | | | | |
| 4: | 9.7 | ↑ | | | | | | | | | | | | | | | | | | | | | | | | | | | | | | | | | | | |
| 5: | 10.3 | ↗ | | | | | | | | | | | | | | | | | | | | | | | | | | | | | | | | | | | |
| 6: | 9.9 | ← | | | | | | | | | | | | | | | | | | | | | | | | | | | | | | | | | | | |
| 7: | *10.8 | ← | | | | | | | | | | | | | | | | | | | | | | | | | | | | | | | | | | | |
| 8: | 10.3 | ↘ | | | | | | | | | | | | | | | | | | | | | | | | | | | | | | | | | | | |
| 9: | *10.6 | ← | | | | | | | | | | | | | | | | | | | | | | | | | | | | | | | | | | | |
| 10: | *10.5 | ↘ | | | | | | | | | | | | | | | | | | | | | | | | | | | | | | | | | | | |
| Serie | | 96.0 | | | | | | | | | | | | | | | | | | | | | | | | | | | | | | | | | | | |
| Total | | 0.0 | | | | | | | | | | | | | | | | | | | | | | | | | | | | | | | | | | | |

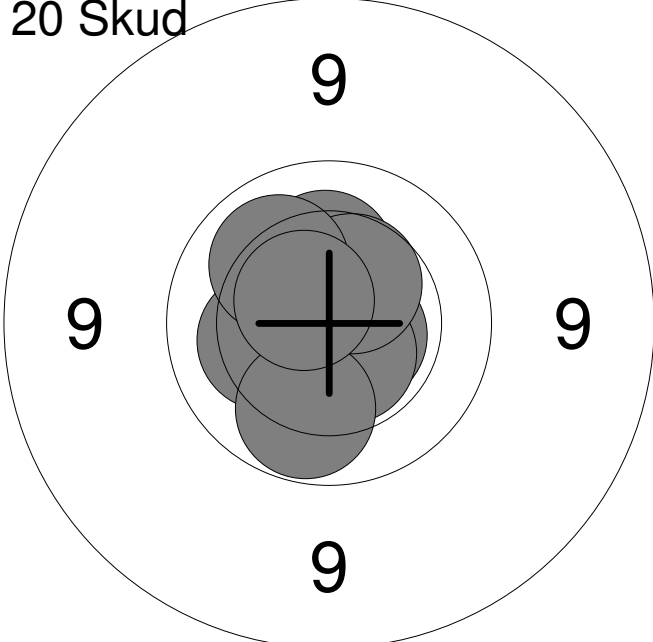
| | | | | | | | | | | | | | | | | | | | | | | | | | | | | | | | | | | | | | |
|---|---|-------|------|---|----|-------|---|----|-------|---|----|-------|---|----|------|---|----|------|---|----|------|---|----|------|---|----|------|---|-----|-------|---|-------|--|-------|-------|--|-------|
| <p>20 Skud</p>  | <table style="width:100%; border-collapse: collapse;"> <tr><td>1:</td><td>10.4</td><td>↑</td></tr> <tr><td>2:</td><td>*10.8</td><td>↑</td></tr> <tr><td>3:</td><td>*10.6</td><td>→</td></tr> <tr><td>4:</td><td>*10.6</td><td>↘</td></tr> <tr><td>5:</td><td>10.3</td><td>←</td></tr> <tr><td>6:</td><td>10.3</td><td>↑</td></tr> <tr><td>7:</td><td>10.0</td><td>↘</td></tr> <tr><td>8:</td><td>10.5</td><td>↗</td></tr> <tr><td>9:</td><td>10.1</td><td>↗</td></tr> <tr><td>10:</td><td>*10.6</td><td>↗</td></tr> <tr style="border-top: 1px solid black;"><td colspan="2">Serie</td><td>100.0</td></tr> <tr><td colspan="2">Total</td><td>100.0</td></tr> </table> | 1: | 10.4 | ↑ | 2: | *10.8 | ↑ | 3: | *10.6 | → | 4: | *10.6 | ↘ | 5: | 10.3 | ← | 6: | 10.3 | ↑ | 7: | 10.0 | ↘ | 8: | 10.5 | ↗ | 9: | 10.1 | ↗ | 10: | *10.6 | ↗ | Serie | | 100.0 | Total | | 100.0 |
| 1: | 10.4 | ↑ | | | | | | | | | | | | | | | | | | | | | | | | | | | | | | | | | | | |
| 2: | *10.8 | ↑ | | | | | | | | | | | | | | | | | | | | | | | | | | | | | | | | | | | |
| 3: | *10.6 | → | | | | | | | | | | | | | | | | | | | | | | | | | | | | | | | | | | | |
| 4: | *10.6 | ↘ | | | | | | | | | | | | | | | | | | | | | | | | | | | | | | | | | | | |
| 5: | 10.3 | ← | | | | | | | | | | | | | | | | | | | | | | | | | | | | | | | | | | | |
| 6: | 10.3 | ↑ | | | | | | | | | | | | | | | | | | | | | | | | | | | | | | | | | | | |
| 7: | 10.0 | ↘ | | | | | | | | | | | | | | | | | | | | | | | | | | | | | | | | | | | |
| 8: | 10.5 | ↗ | | | | | | | | | | | | | | | | | | | | | | | | | | | | | | | | | | | |
| 9: | 10.1 | ↗ | | | | | | | | | | | | | | | | | | | | | | | | | | | | | | | | | | | |
| 10: | *10.6 | ↗ | | | | | | | | | | | | | | | | | | | | | | | | | | | | | | | | | | | |
| Serie | | 100.0 | | | | | | | | | | | | | | | | | | | | | | | | | | | | | | | | | | | |
| Total | | 100.0 | | | | | | | | | | | | | | | | | | | | | | | | | | | | | | | | | | | |

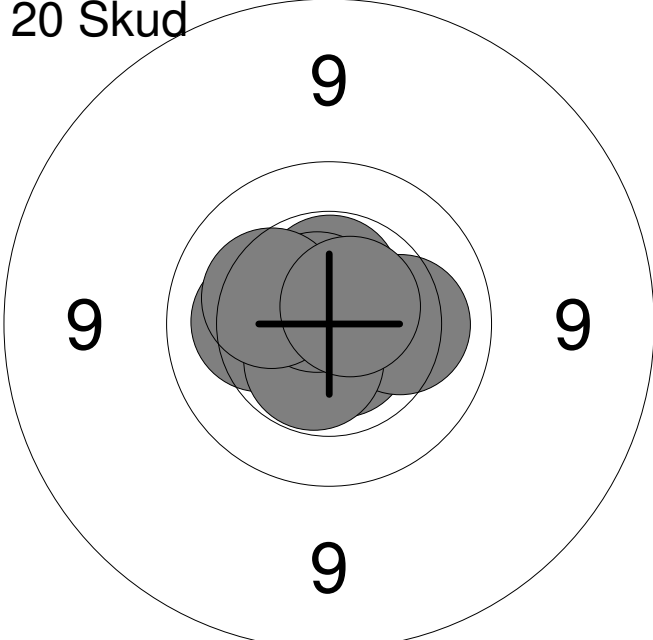
| | | | | | | | | | | | | | | | | | | | | | | | | | | | | | | | | | | | | | |
|--|---|-------|-------|---|-----|-------|---|-----|------|---|-----|-------|---|-----|------|---|-----|-------|---|-----|-------|---|-----|-------|---|-----|------|---|-----|-------|---|-------|--|-------|-------|--|-------|
| <p>20 Skud</p>  | <table style="width:100%; border-collapse: collapse;"> <tr><td>11:</td><td>*10.7</td><td>↘</td></tr> <tr><td>12:</td><td>*10.8</td><td>←</td></tr> <tr><td>13:</td><td>10.2</td><td>→</td></tr> <tr><td>14:</td><td>*10.7</td><td>↘</td></tr> <tr><td>15:</td><td>10.2</td><td>←</td></tr> <tr><td>16:</td><td>*10.5</td><td>↘</td></tr> <tr><td>17:</td><td>*10.5</td><td>↑</td></tr> <tr><td>18:</td><td>*10.7</td><td>↗</td></tr> <tr><td>19:</td><td>10.3</td><td>↗</td></tr> <tr><td>20:</td><td>*10.7</td><td>↗</td></tr> <tr style="border-top: 1px solid black;"><td colspan="2">Serie</td><td>100.0</td></tr> <tr><td colspan="2">Total</td><td>200.0</td></tr> </table> | 11: | *10.7 | ↘ | 12: | *10.8 | ← | 13: | 10.2 | → | 14: | *10.7 | ↘ | 15: | 10.2 | ← | 16: | *10.5 | ↘ | 17: | *10.5 | ↑ | 18: | *10.7 | ↗ | 19: | 10.3 | ↗ | 20: | *10.7 | ↗ | Serie | | 100.0 | Total | | 200.0 |
| 11: | *10.7 | ↘ | | | | | | | | | | | | | | | | | | | | | | | | | | | | | | | | | | | |
| 12: | *10.8 | ← | | | | | | | | | | | | | | | | | | | | | | | | | | | | | | | | | | | |
| 13: | 10.2 | → | | | | | | | | | | | | | | | | | | | | | | | | | | | | | | | | | | | |
| 14: | *10.7 | ↘ | | | | | | | | | | | | | | | | | | | | | | | | | | | | | | | | | | | |
| 15: | 10.2 | ← | | | | | | | | | | | | | | | | | | | | | | | | | | | | | | | | | | | |
| 16: | *10.5 | ↘ | | | | | | | | | | | | | | | | | | | | | | | | | | | | | | | | | | | |
| 17: | *10.5 | ↑ | | | | | | | | | | | | | | | | | | | | | | | | | | | | | | | | | | | |
| 18: | *10.7 | ↗ | | | | | | | | | | | | | | | | | | | | | | | | | | | | | | | | | | | |
| 19: | 10.3 | ↗ | | | | | | | | | | | | | | | | | | | | | | | | | | | | | | | | | | | |
| 20: | *10.7 | ↗ | | | | | | | | | | | | | | | | | | | | | | | | | | | | | | | | | | | |
| Serie | | 100.0 | | | | | | | | | | | | | | | | | | | | | | | | | | | | | | | | | | | |
| Total | | 200.0 | | | | | | | | | | | | | | | | | | | | | | | | | | | | | | | | | | | |

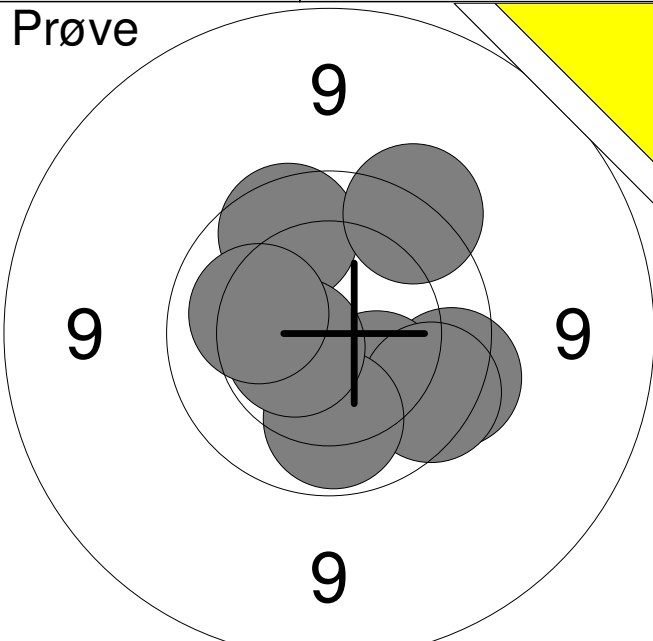
| | | | | | | | | | | | | | | | | | | | | | | | | | | | | | |
|--|---|----|-----|---|----|------|---|----|-----|---|----|------|---|----|-----|---|----|-----|---|----|-------|---|----|------|---|-------|------|-------|-----|
| <p>Prøve</p>  | <table style="width:100%; border-collapse: collapse;"> <tr><td style="width:10%;">1:</td><td style="width:15%;">9.7</td><td style="width:10%; text-align:right;">→</td></tr> <tr><td>2:</td><td>10.2</td><td style="text-align:right;">↓</td></tr> <tr><td>3:</td><td>9.8</td><td style="text-align:right;">↓</td></tr> <tr><td>4:</td><td>10.0</td><td style="text-align:right;">↓</td></tr> <tr><td>5:</td><td>9.9</td><td style="text-align:right;">↑</td></tr> <tr><td>6:</td><td>9.6</td><td style="text-align:right;">↑</td></tr> <tr><td>7:</td><td>*10.6</td><td style="text-align:right;">←</td></tr> <tr><td>8:</td><td>10.2</td><td style="text-align:right;">←</td></tr> </table> <table border="1" style="width:100%; border-collapse: collapse; margin-top: 5px;"> <tr> <td style="width:80%;">Serie</td> <td style="text-align:right;">76.0</td> </tr> <tr> <td>Total</td> <td style="text-align:right;">0.0</td> </tr> </table> | 1: | 9.7 | → | 2: | 10.2 | ↓ | 3: | 9.8 | ↓ | 4: | 10.0 | ↓ | 5: | 9.9 | ↑ | 6: | 9.6 | ↑ | 7: | *10.6 | ← | 8: | 10.2 | ← | Serie | 76.0 | Total | 0.0 |
| 1: | 9.7 | → | | | | | | | | | | | | | | | | | | | | | | | | | | | |
| 2: | 10.2 | ↓ | | | | | | | | | | | | | | | | | | | | | | | | | | | |
| 3: | 9.8 | ↓ | | | | | | | | | | | | | | | | | | | | | | | | | | | |
| 4: | 10.0 | ↓ | | | | | | | | | | | | | | | | | | | | | | | | | | | |
| 5: | 9.9 | ↑ | | | | | | | | | | | | | | | | | | | | | | | | | | | |
| 6: | 9.6 | ↑ | | | | | | | | | | | | | | | | | | | | | | | | | | | |
| 7: | *10.6 | ← | | | | | | | | | | | | | | | | | | | | | | | | | | | |
| 8: | 10.2 | ← | | | | | | | | | | | | | | | | | | | | | | | | | | | |
| Serie | 76.0 | | | | | | | | | | | | | | | | | | | | | | | | | | | | |
| Total | 0.0 | | | | | | | | | | | | | | | | | | | | | | | | | | | | |

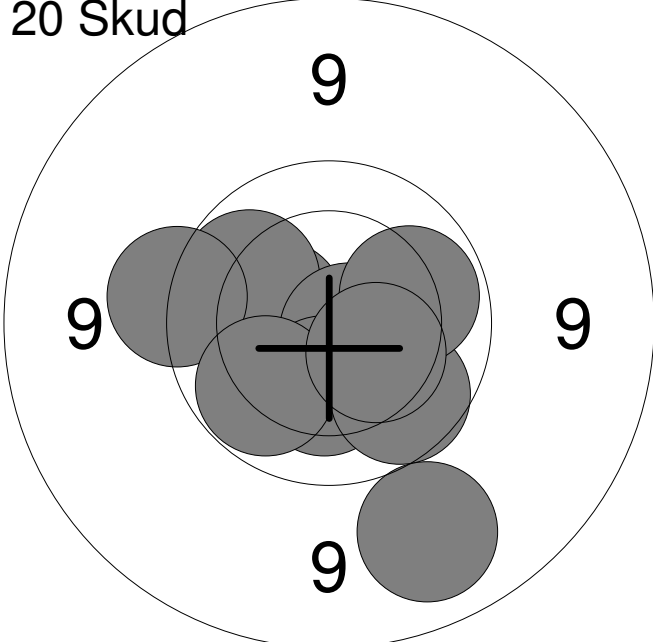
| | | | | | | | | | | | | | | | | | | | | | | | | | | | | | | | | | | | |
|---|--|----|------|---|----|------|---|----|-------|---|----|------|---|----|-----|---|----|-----|---|----|------|---|----|------|---|----|-----|---|-----|------|---|-------|------|-------|------|
| <p>20 Skud</p>  | <table style="width:100%; border-collapse: collapse;"> <tr><td style="width:10%;">1:</td><td style="width:15%;">10.4</td><td style="width:10%; text-align:right;">←</td></tr> <tr><td>2:</td><td>10.0</td><td style="text-align:right;">↑</td></tr> <tr><td>3:</td><td>*10.7</td><td style="text-align:right;">↓</td></tr> <tr><td>4:</td><td>10.3</td><td style="text-align:right;">↓</td></tr> <tr><td>5:</td><td>9.6</td><td style="text-align:right;">←</td></tr> <tr><td>6:</td><td>9.9</td><td style="text-align:right;">↓</td></tr> <tr><td>7:</td><td>10.0</td><td style="text-align:right;">←</td></tr> <tr><td>8:</td><td>10.0</td><td style="text-align:right;">→</td></tr> <tr><td>9:</td><td>9.1</td><td style="text-align:right;">↓</td></tr> <tr><td>10:</td><td>10.4</td><td style="text-align:right;">↓</td></tr> </table> <table border="1" style="width:100%; border-collapse: collapse; margin-top: 5px;"> <tr> <td style="width:80%;">Serie</td> <td style="text-align:right;">97.0</td> </tr> <tr> <td>Total</td> <td style="text-align:right;">97.0</td> </tr> </table> | 1: | 10.4 | ← | 2: | 10.0 | ↑ | 3: | *10.7 | ↓ | 4: | 10.3 | ↓ | 5: | 9.6 | ← | 6: | 9.9 | ↓ | 7: | 10.0 | ← | 8: | 10.0 | → | 9: | 9.1 | ↓ | 10: | 10.4 | ↓ | Serie | 97.0 | Total | 97.0 |
| 1: | 10.4 | ← | | | | | | | | | | | | | | | | | | | | | | | | | | | | | | | | | |
| 2: | 10.0 | ↑ | | | | | | | | | | | | | | | | | | | | | | | | | | | | | | | | | |
| 3: | *10.7 | ↓ | | | | | | | | | | | | | | | | | | | | | | | | | | | | | | | | | |
| 4: | 10.3 | ↓ | | | | | | | | | | | | | | | | | | | | | | | | | | | | | | | | | |
| 5: | 9.6 | ← | | | | | | | | | | | | | | | | | | | | | | | | | | | | | | | | | |
| 6: | 9.9 | ↓ | | | | | | | | | | | | | | | | | | | | | | | | | | | | | | | | | |
| 7: | 10.0 | ← | | | | | | | | | | | | | | | | | | | | | | | | | | | | | | | | | |
| 8: | 10.0 | → | | | | | | | | | | | | | | | | | | | | | | | | | | | | | | | | | |
| 9: | 9.1 | ↓ | | | | | | | | | | | | | | | | | | | | | | | | | | | | | | | | | |
| 10: | 10.4 | ↓ | | | | | | | | | | | | | | | | | | | | | | | | | | | | | | | | | |
| Serie | 97.0 | | | | | | | | | | | | | | | | | | | | | | | | | | | | | | | | | | |
| Total | 97.0 | | | | | | | | | | | | | | | | | | | | | | | | | | | | | | | | | | |

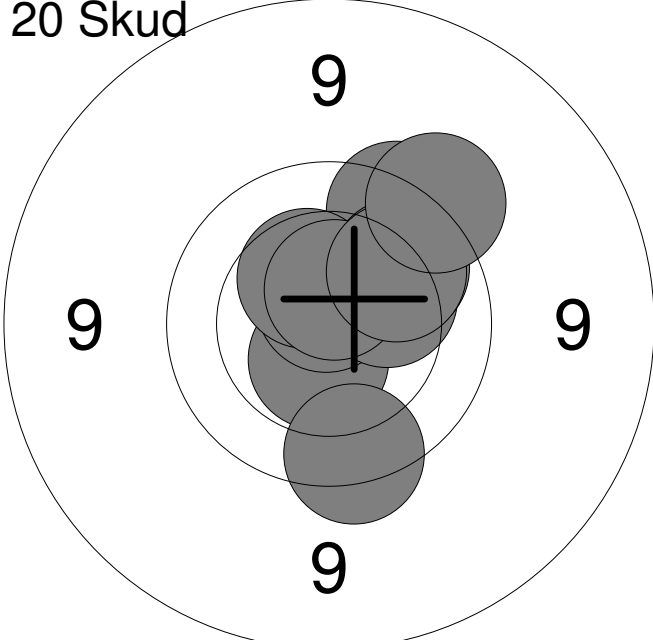
| | | | | | | | | | | | | | | | | | | | | | | | | | | | | | | | | | | | |
|--|--|-----|-------|---|-----|-------|---|-----|-----|---|-----|-----|---|-----|------|---|-----|------|---|-----|------|---|-----|-------|---|-----|------|---|-----|-----|---|-------|------|-------|-------|
| <p>20 Skud</p>  | <table style="width:100%; border-collapse: collapse;"> <tr><td style="width:10%;">11:</td><td style="width:15%;">*10.6</td><td style="width:10%; text-align:right;">↓</td></tr> <tr><td>12:</td><td>*10.7</td><td style="text-align:right;">↑</td></tr> <tr><td>13:</td><td>9.7</td><td style="text-align:right;">↑</td></tr> <tr><td>14:</td><td>9.7</td><td style="text-align:right;">↓</td></tr> <tr><td>15:</td><td>10.3</td><td style="text-align:right;">→</td></tr> <tr><td>16:</td><td>10.4</td><td style="text-align:right;">↑</td></tr> <tr><td>17:</td><td>10.0</td><td style="text-align:right;">→</td></tr> <tr><td>18:</td><td>*10.6</td><td style="text-align:right;">↑</td></tr> <tr><td>19:</td><td>10.0</td><td style="text-align:right;">→</td></tr> <tr><td>20:</td><td>9.5</td><td style="text-align:right;">↑</td></tr> </table> <table border="1" style="width:100%; border-collapse: collapse; margin-top: 5px;"> <tr> <td style="width:80%;">Serie</td> <td style="text-align:right;">97.0</td> </tr> <tr> <td>Total</td> <td style="text-align:right;">194.0</td> </tr> </table> | 11: | *10.6 | ↓ | 12: | *10.7 | ↑ | 13: | 9.7 | ↑ | 14: | 9.7 | ↓ | 15: | 10.3 | → | 16: | 10.4 | ↑ | 17: | 10.0 | → | 18: | *10.6 | ↑ | 19: | 10.0 | → | 20: | 9.5 | ↑ | Serie | 97.0 | Total | 194.0 |
| 11: | *10.6 | ↓ | | | | | | | | | | | | | | | | | | | | | | | | | | | | | | | | | |
| 12: | *10.7 | ↑ | | | | | | | | | | | | | | | | | | | | | | | | | | | | | | | | | |
| 13: | 9.7 | ↑ | | | | | | | | | | | | | | | | | | | | | | | | | | | | | | | | | |
| 14: | 9.7 | ↓ | | | | | | | | | | | | | | | | | | | | | | | | | | | | | | | | | |
| 15: | 10.3 | → | | | | | | | | | | | | | | | | | | | | | | | | | | | | | | | | | |
| 16: | 10.4 | ↑ | | | | | | | | | | | | | | | | | | | | | | | | | | | | | | | | | |
| 17: | 10.0 | → | | | | | | | | | | | | | | | | | | | | | | | | | | | | | | | | | |
| 18: | *10.6 | ↑ | | | | | | | | | | | | | | | | | | | | | | | | | | | | | | | | | |
| 19: | 10.0 | → | | | | | | | | | | | | | | | | | | | | | | | | | | | | | | | | | |
| 20: | 9.5 | ↑ | | | | | | | | | | | | | | | | | | | | | | | | | | | | | | | | | |
| Serie | 97.0 | | | | | | | | | | | | | | | | | | | | | | | | | | | | | | | | | | |
| Total | 194.0 | | | | | | | | | | | | | | | | | | | | | | | | | | | | | | | | | | |

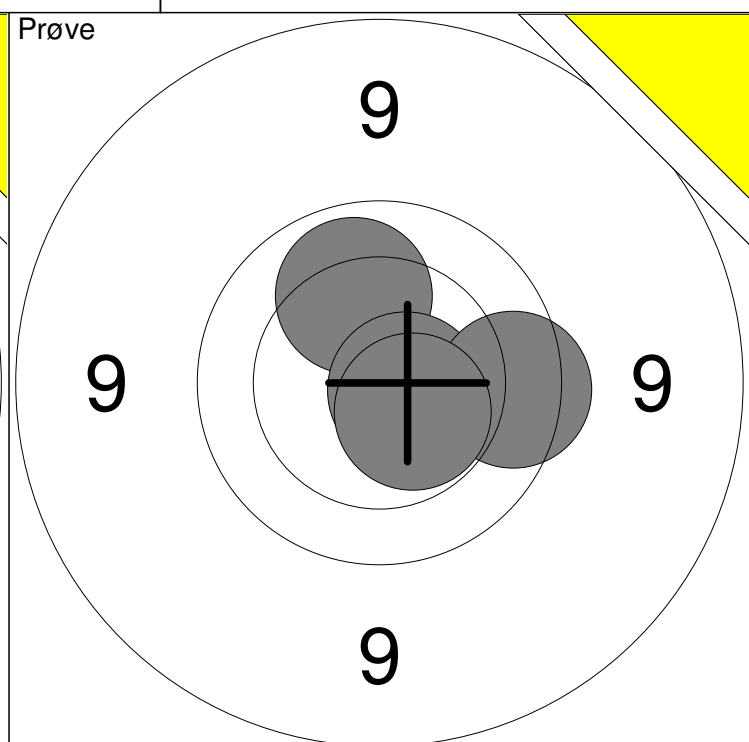
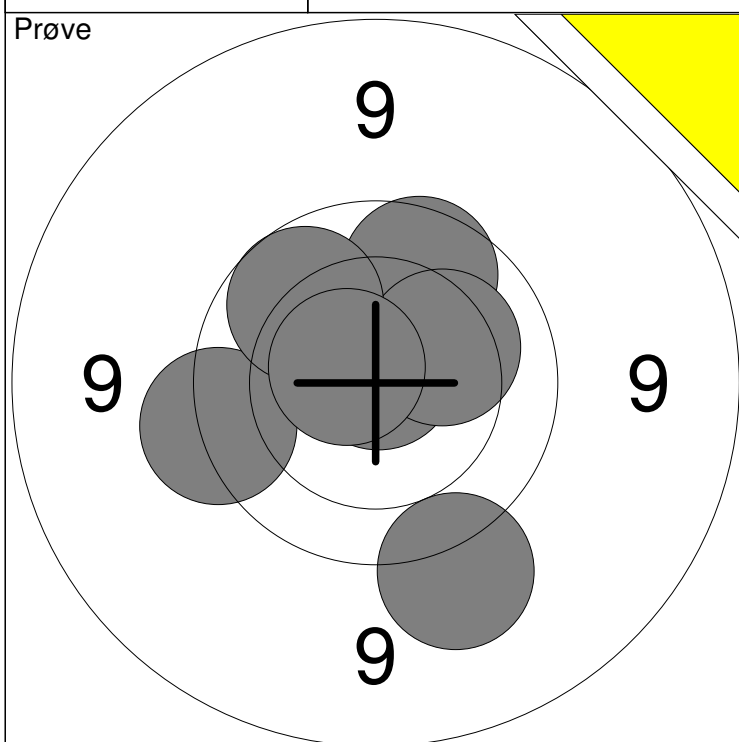

| | | | |
|------------|-------------|-------|------|
| 1: 9.6 ← | 6: *10.8 ↗ | Serie | 96.0 |
| 2: 9.4 ↓ | 7: 9.9 ↗ | | |
| 3: *10.7 ↑ | 8: 10.2 ↘ | Total | 0.0 |
| 4: 10.4 ↗ | 9: 9.9 ↖ | | |
| 5: 10.2 ↗ | 10: *10.6 ← | | |

| | | |
|-------------|-------|------|
| 11: 10.1 ↗ | Serie | 39.0 |
| 12: *10.7 → | | |
| 13: 9.8 → | Total | 0.0 |
| 14: *10.5 ↓ | | |

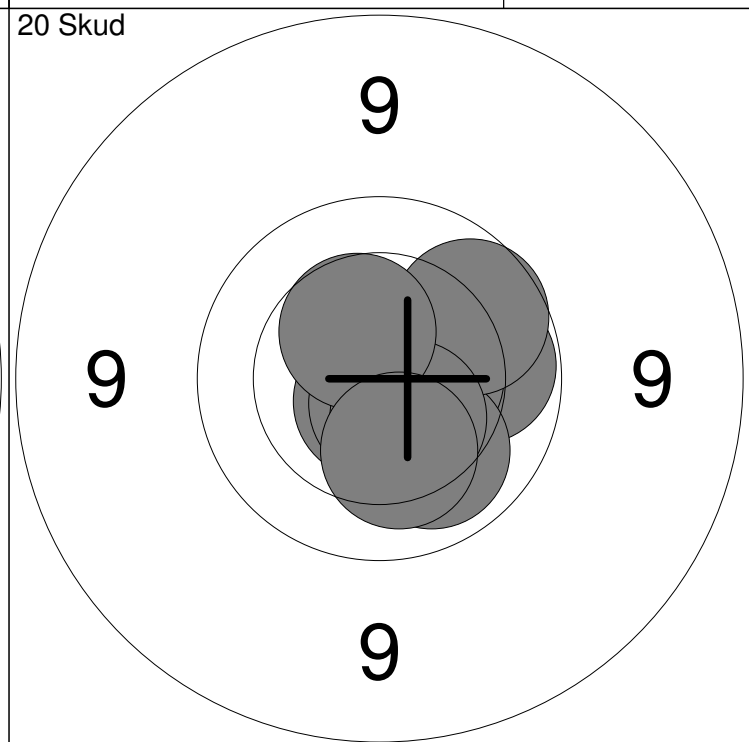
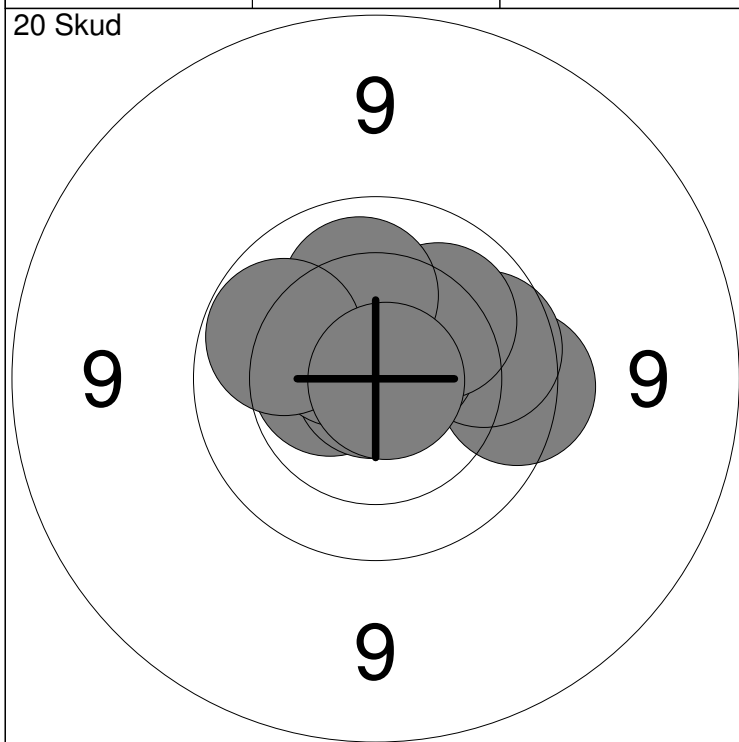

| | | | |
|------------|-------------|-------|------|
| 1: 9.7 → | 6: *10.6 ↗ | Serie | 98.0 |
| 2: *10.5 ← | 7: 10.1 ↗ | | |
| 3: 9.9 → | 8: 10.1 ↑ | Total | 98.0 |
| 4: *10.9 ← | 9: 10.0 ← | | |
| 5: *10.5 ↖ | 10: *10.8 → | | |

| | | | |
|-------------|------------|-------|-------|
| 11: *10.7 ↓ | 16: 10.1 ↓ | Serie | 99.0 |
| 12: 10.0 → | 17: 9.9 ↗ | | |
| 13: *10.7 ↗ | 18: 10.5 ↓ | Total | 197.0 |
| 14: *10.5 → | 19: 10.4 ↗ | | |
| 15: *10.7 ↓ | 20: 10.2 ↓ | | |

| | | | | | | | | | | | | | | | | | | | | | | | |
|---------------------|---|----|-----|---|----|-----|---|----|-----|---|----|------|---|----|------|---|----|-------|---|-------|------|-------|-----|
| <p>Prøve</p> | <table style="width:100%; border-collapse: collapse;"> <tr><td style="text-align:right;">1:</td><td style="text-align:left;">9.1</td><td style="text-align:right;">↗</td></tr> <tr><td style="text-align:right;">2:</td><td style="text-align:left;">9.6</td><td style="text-align:right;">→</td></tr> <tr><td style="text-align:right;">3:</td><td style="text-align:left;">9.9</td><td style="text-align:right;">↗</td></tr> <tr><td style="text-align:right;">4:</td><td style="text-align:left;">10.3</td><td style="text-align:right;">↗</td></tr> <tr><td style="text-align:right;">5:</td><td style="text-align:left;">10.4</td><td style="text-align:right;">↗</td></tr> <tr><td style="text-align:right;">6:</td><td style="text-align:left;">*10.7</td><td style="text-align:right;">↖</td></tr> </table> <table border="1" style="width:100%; border-collapse: collapse; margin-top: 5px;"> <tr> <td style="width:80%;">Serie</td> <td style="text-align:right;">57.0</td> </tr> <tr> <td>Total</td> <td style="text-align:right;">0.0</td> </tr> </table> | 1: | 9.1 | ↗ | 2: | 9.6 | → | 3: | 9.9 | ↗ | 4: | 10.3 | ↗ | 5: | 10.4 | ↗ | 6: | *10.7 | ↖ | Serie | 57.0 | Total | 0.0 |
| 1: | 9.1 | ↗ | | | | | | | | | | | | | | | | | | | | | |
| 2: | 9.6 | → | | | | | | | | | | | | | | | | | | | | | |
| 3: | 9.9 | ↗ | | | | | | | | | | | | | | | | | | | | | |
| 4: | 10.3 | ↗ | | | | | | | | | | | | | | | | | | | | | |
| 5: | 10.4 | ↗ | | | | | | | | | | | | | | | | | | | | | |
| 6: | *10.7 | ↖ | | | | | | | | | | | | | | | | | | | | | |
| Serie | 57.0 | | | | | | | | | | | | | | | | | | | | | | |
| Total | 0.0 | | | | | | | | | | | | | | | | | | | | | | |

| | | | | | | | | | | | | | | | | | | | | | | | | | | | | | | | | | | | |
|-----------------------|---|----|-------|---|----|-----|---|----|------|---|----|------|---|----|------|---|----|------|---|----|------|---|----|------|---|----|------|---|-----|------|---|-------|------|-------|------|
| <p>20 Skud</p> | <table style="width:100%; border-collapse: collapse;"> <tr><td style="text-align:right;">1:</td><td style="text-align:left;">*10.5</td><td style="text-align:right;">↖</td></tr> <tr><td style="text-align:right;">2:</td><td style="text-align:left;">9.6</td><td style="text-align:right;">↗</td></tr> <tr><td style="text-align:right;">3:</td><td style="text-align:left;">10.1</td><td style="text-align:right;">↗</td></tr> <tr><td style="text-align:right;">4:</td><td style="text-align:left;">10.1</td><td style="text-align:right;">↗</td></tr> <tr><td style="text-align:right;">5:</td><td style="text-align:left;">10.3</td><td style="text-align:right;">↗</td></tr> <tr><td style="text-align:right;">6:</td><td style="text-align:left;">10.0</td><td style="text-align:right;">↖</td></tr> <tr><td style="text-align:right;">7:</td><td style="text-align:left;">10.3</td><td style="text-align:right;">↗</td></tr> <tr><td style="text-align:right;">8:</td><td style="text-align:left;">10.5</td><td style="text-align:right;">↖</td></tr> <tr><td style="text-align:right;">9:</td><td style="text-align:left;">10.0</td><td style="text-align:right;">↗</td></tr> <tr><td style="text-align:right;">10:</td><td style="text-align:left;">10.0</td><td style="text-align:right;">↖</td></tr> </table> <table border="1" style="width:100%; border-collapse: collapse; margin-top: 5px;"> <tr> <td style="width:80%;">Serie</td> <td style="text-align:right;">99.0</td> </tr> <tr> <td>Total</td> <td style="text-align:right;">99.0</td> </tr> </table> | 1: | *10.5 | ↖ | 2: | 9.6 | ↗ | 3: | 10.1 | ↗ | 4: | 10.1 | ↗ | 5: | 10.3 | ↗ | 6: | 10.0 | ↖ | 7: | 10.3 | ↗ | 8: | 10.5 | ↖ | 9: | 10.0 | ↗ | 10: | 10.0 | ↖ | Serie | 99.0 | Total | 99.0 |
| 1: | *10.5 | ↖ | | | | | | | | | | | | | | | | | | | | | | | | | | | | | | | | | |
| 2: | 9.6 | ↗ | | | | | | | | | | | | | | | | | | | | | | | | | | | | | | | | | |
| 3: | 10.1 | ↗ | | | | | | | | | | | | | | | | | | | | | | | | | | | | | | | | | |
| 4: | 10.1 | ↗ | | | | | | | | | | | | | | | | | | | | | | | | | | | | | | | | | |
| 5: | 10.3 | ↗ | | | | | | | | | | | | | | | | | | | | | | | | | | | | | | | | | |
| 6: | 10.0 | ↖ | | | | | | | | | | | | | | | | | | | | | | | | | | | | | | | | | |
| 7: | 10.3 | ↗ | | | | | | | | | | | | | | | | | | | | | | | | | | | | | | | | | |
| 8: | 10.5 | ↖ | | | | | | | | | | | | | | | | | | | | | | | | | | | | | | | | | |
| 9: | 10.0 | ↗ | | | | | | | | | | | | | | | | | | | | | | | | | | | | | | | | | |
| 10: | 10.0 | ↖ | | | | | | | | | | | | | | | | | | | | | | | | | | | | | | | | | |
| Serie | 99.0 | | | | | | | | | | | | | | | | | | | | | | | | | | | | | | | | | | |
| Total | 99.0 | | | | | | | | | | | | | | | | | | | | | | | | | | | | | | | | | | |

| | | | | | | | | | | | | | | | | | | | | | | | | | | | | | | | | | | | |
|-----------------------|--|-----|------|---|-----|-------|---|-----|------|---|-----|------|---|-----|------|---|-----|-------|---|-----|------|---|-----|------|---|-----|-------|---|-----|-------|---|-------|-------|-------|-------|
| <p>20 Skud</p> | <table style="width:100%; border-collapse: collapse;"> <tr><td style="text-align:right;">11:</td><td style="text-align:left;">10.0</td><td style="text-align:right;">↗</td></tr> <tr><td style="text-align:right;">12:</td><td style="text-align:left;">*10.6</td><td style="text-align:right;">↗</td></tr> <tr><td style="text-align:right;">13:</td><td style="text-align:left;">10.1</td><td style="text-align:right;">↖</td></tr> <tr><td style="text-align:right;">14:</td><td style="text-align:left;">10.0</td><td style="text-align:right;">↘</td></tr> <tr><td style="text-align:right;">15:</td><td style="text-align:left;">10.1</td><td style="text-align:right;">↗</td></tr> <tr><td style="text-align:right;">16:</td><td style="text-align:left;">*10.8</td><td style="text-align:right;">→</td></tr> <tr><td style="text-align:right;">17:</td><td style="text-align:left;">10.3</td><td style="text-align:right;">↘</td></tr> <tr><td style="text-align:right;">18:</td><td style="text-align:left;">10.2</td><td style="text-align:right;">↘</td></tr> <tr><td style="text-align:right;">19:</td><td style="text-align:left;">*10.6</td><td style="text-align:right;">↖</td></tr> <tr><td style="text-align:right;">20:</td><td style="text-align:left;">*10.8</td><td style="text-align:right;">→</td></tr> </table> <table border="1" style="width:100%; border-collapse: collapse; margin-top: 5px;"> <tr> <td style="width:80%;">Serie</td> <td style="text-align:right;">100.0</td> </tr> <tr> <td>Total</td> <td style="text-align:right;">199.0</td> </tr> </table> | 11: | 10.0 | ↗ | 12: | *10.6 | ↗ | 13: | 10.1 | ↖ | 14: | 10.0 | ↘ | 15: | 10.1 | ↗ | 16: | *10.8 | → | 17: | 10.3 | ↘ | 18: | 10.2 | ↘ | 19: | *10.6 | ↖ | 20: | *10.8 | → | Serie | 100.0 | Total | 199.0 |
| 11: | 10.0 | ↗ | | | | | | | | | | | | | | | | | | | | | | | | | | | | | | | | | |
| 12: | *10.6 | ↗ | | | | | | | | | | | | | | | | | | | | | | | | | | | | | | | | | |
| 13: | 10.1 | ↖ | | | | | | | | | | | | | | | | | | | | | | | | | | | | | | | | | |
| 14: | 10.0 | ↘ | | | | | | | | | | | | | | | | | | | | | | | | | | | | | | | | | |
| 15: | 10.1 | ↗ | | | | | | | | | | | | | | | | | | | | | | | | | | | | | | | | | |
| 16: | *10.8 | → | | | | | | | | | | | | | | | | | | | | | | | | | | | | | | | | | |
| 17: | 10.3 | ↘ | | | | | | | | | | | | | | | | | | | | | | | | | | | | | | | | | |
| 18: | 10.2 | ↘ | | | | | | | | | | | | | | | | | | | | | | | | | | | | | | | | | |
| 19: | *10.6 | ↖ | | | | | | | | | | | | | | | | | | | | | | | | | | | | | | | | | |
| 20: | *10.8 | → | | | | | | | | | | | | | | | | | | | | | | | | | | | | | | | | | |
| Serie | 100.0 | | | | | | | | | | | | | | | | | | | | | | | | | | | | | | | | | | |
| Total | 199.0 | | | | | | | | | | | | | | | | | | | | | | | | | | | | | | | | | | |

| | | | | | | | | | | | | | | |
|---------------------|--|----|------|---|----|------|---|----|-------|---|-------|------|-------|-----|
| <p>Prøve</p> | <table style="width:100%; border-collapse: collapse;"> <tr><td style="width:10%;">1:</td><td style="width:15%;">10.0</td><td style="width:10%; text-align: right;">←</td></tr> <tr><td>2:</td><td>10.0</td><td style="text-align: right;">→</td></tr> <tr><td>3:</td><td>*10.6</td><td style="text-align: right;">↘</td></tr> </table> <hr/> <table style="width:100%; border-collapse: collapse;"> <tr><td style="width:80%;">Serie</td><td style="text-align: right;">30.0</td></tr> <tr><td>Total</td><td style="text-align: right;">0.0</td></tr> </table> | 1: | 10.0 | ← | 2: | 10.0 | → | 3: | *10.6 | ↘ | Serie | 30.0 | Total | 0.0 |
| 1: | 10.0 | ← | | | | | | | | | | | | |
| 2: | 10.0 | → | | | | | | | | | | | | |
| 3: | *10.6 | ↘ | | | | | | | | | | | | |
| Serie | 30.0 | | | | | | | | | | | | | |
| Total | 0.0 | | | | | | | | | | | | | |

| | | | | | | | | | | | | | | | | | | | | | | | | | | | | | | | | | | | |
|-----------------------|--|----|-----|---|----|-------|---|----|------|---|----|------|---|----|-------|---|----|-------|---|----|------|---|----|-------|---|----|-----|---|-----|------|---|-------|------|-------|------|
| <p>20 Skud</p> | <table style="width:100%; border-collapse: collapse;"> <tr><td style="width:10%;">1:</td><td style="width:15%;">9.9</td><td style="width:10%; text-align: right;">↙</td></tr> <tr><td>2:</td><td>*10.8</td><td style="text-align: right;">↑</td></tr> <tr><td>3:</td><td>10.4</td><td style="text-align: right;">↗</td></tr> <tr><td>4:</td><td>10.0</td><td style="text-align: right;">←</td></tr> <tr><td>5:</td><td>*10.5</td><td style="text-align: right;">↙</td></tr> <tr><td>6:</td><td>*10.6</td><td style="text-align: right;">↗</td></tr> <tr><td>7:</td><td>10.4</td><td style="text-align: right;">↘</td></tr> <tr><td>8:</td><td>*10.9</td><td style="text-align: right;">↗</td></tr> <tr><td>9:</td><td>9.8</td><td style="text-align: right;">←</td></tr> <tr><td>10:</td><td>10.4</td><td style="text-align: right;">←</td></tr> </table> <hr/> <table style="width:100%; border-collapse: collapse;"> <tr><td style="width:80%;">Serie</td><td style="text-align: right;">98.0</td></tr> <tr><td>Total</td><td style="text-align: right;">98.0</td></tr> </table> | 1: | 9.9 | ↙ | 2: | *10.8 | ↑ | 3: | 10.4 | ↗ | 4: | 10.0 | ← | 5: | *10.5 | ↙ | 6: | *10.6 | ↗ | 7: | 10.4 | ↘ | 8: | *10.9 | ↗ | 9: | 9.8 | ← | 10: | 10.4 | ← | Serie | 98.0 | Total | 98.0 |
| 1: | 9.9 | ↙ | | | | | | | | | | | | | | | | | | | | | | | | | | | | | | | | | |
| 2: | *10.8 | ↑ | | | | | | | | | | | | | | | | | | | | | | | | | | | | | | | | | |
| 3: | 10.4 | ↗ | | | | | | | | | | | | | | | | | | | | | | | | | | | | | | | | | |
| 4: | 10.0 | ← | | | | | | | | | | | | | | | | | | | | | | | | | | | | | | | | | |
| 5: | *10.5 | ↙ | | | | | | | | | | | | | | | | | | | | | | | | | | | | | | | | | |
| 6: | *10.6 | ↗ | | | | | | | | | | | | | | | | | | | | | | | | | | | | | | | | | |
| 7: | 10.4 | ↘ | | | | | | | | | | | | | | | | | | | | | | | | | | | | | | | | | |
| 8: | *10.9 | ↗ | | | | | | | | | | | | | | | | | | | | | | | | | | | | | | | | | |
| 9: | 9.8 | ← | | | | | | | | | | | | | | | | | | | | | | | | | | | | | | | | | |
| 10: | 10.4 | ← | | | | | | | | | | | | | | | | | | | | | | | | | | | | | | | | | |
| Serie | 98.0 | | | | | | | | | | | | | | | | | | | | | | | | | | | | | | | | | | |
| Total | 98.0 | | | | | | | | | | | | | | | | | | | | | | | | | | | | | | | | | | |

| | | | | | | | | | | | | | | | | | | | | | | | | | | | | | | | | | | | |
|-----------------------|---|-----|------|---|-----|------|---|-----|------|---|-----|-----|---|-----|-----|---|-----|------|---|-----|------|---|-----|-----|---|-----|-------|---|-----|-------|---|-------|------|-------|-------|
| <p>20 Skud</p> | <table style="width:100%; border-collapse: collapse;"> <tr><td style="width:10%;">11:</td><td style="width:15%;">10.3</td><td style="width:10%; text-align: right;">←</td></tr> <tr><td>12:</td><td>10.5</td><td style="text-align: right;">↗</td></tr> <tr><td>13:</td><td>10.1</td><td style="text-align: right;">↗</td></tr> <tr><td>14:</td><td>9.8</td><td style="text-align: right;">←</td></tr> <tr><td>15:</td><td>9.9</td><td style="text-align: right;">↗</td></tr> <tr><td>16:</td><td>10.5</td><td style="text-align: right;">↓</td></tr> <tr><td>17:</td><td>10.3</td><td style="text-align: right;">↗</td></tr> <tr><td>18:</td><td>9.9</td><td style="text-align: right;">→</td></tr> <tr><td>19:</td><td>*10.5</td><td style="text-align: right;">↗</td></tr> <tr><td>20:</td><td>*10.5</td><td style="text-align: right;">→</td></tr> </table> <hr/> <table style="width:100%; border-collapse: collapse;"> <tr><td style="width:80%;">Serie</td><td style="text-align: right;">97.0</td></tr> <tr><td>Total</td><td style="text-align: right;">195.0</td></tr> </table> | 11: | 10.3 | ← | 12: | 10.5 | ↗ | 13: | 10.1 | ↗ | 14: | 9.8 | ← | 15: | 9.9 | ↗ | 16: | 10.5 | ↓ | 17: | 10.3 | ↗ | 18: | 9.9 | → | 19: | *10.5 | ↗ | 20: | *10.5 | → | Serie | 97.0 | Total | 195.0 |
| 11: | 10.3 | ← | | | | | | | | | | | | | | | | | | | | | | | | | | | | | | | | | |
| 12: | 10.5 | ↗ | | | | | | | | | | | | | | | | | | | | | | | | | | | | | | | | | |
| 13: | 10.1 | ↗ | | | | | | | | | | | | | | | | | | | | | | | | | | | | | | | | | |
| 14: | 9.8 | ← | | | | | | | | | | | | | | | | | | | | | | | | | | | | | | | | | |
| 15: | 9.9 | ↗ | | | | | | | | | | | | | | | | | | | | | | | | | | | | | | | | | |
| 16: | 10.5 | ↓ | | | | | | | | | | | | | | | | | | | | | | | | | | | | | | | | | |
| 17: | 10.3 | ↗ | | | | | | | | | | | | | | | | | | | | | | | | | | | | | | | | | |
| 18: | 9.9 | → | | | | | | | | | | | | | | | | | | | | | | | | | | | | | | | | | |
| 19: | *10.5 | ↗ | | | | | | | | | | | | | | | | | | | | | | | | | | | | | | | | | |
| 20: | *10.5 | → | | | | | | | | | | | | | | | | | | | | | | | | | | | | | | | | | |
| Serie | 97.0 | | | | | | | | | | | | | | | | | | | | | | | | | | | | | | | | | | |
| Total | 195.0 | | | | | | | | | | | | | | | | | | | | | | | | | | | | | | | | | | |

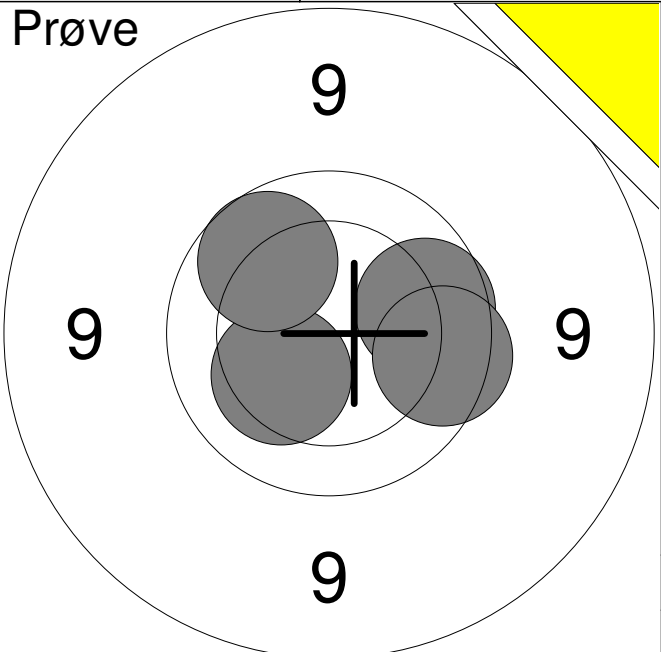
| | | | | | | | | | | | | | | | | | |
|--|--|----|-----|---|----|-----|---|----|------|---|----|-----|---|-------|------|-------|-----|
| <p>Prøve</p>  | <table style="width:100%; border-collapse: collapse;"> <tr><td style="width:10%;">1:</td><td style="width:15%;">9.9</td><td style="width:10%; text-align:right;">→</td></tr> <tr><td>2:</td><td>9.8</td><td style="text-align:right;">→</td></tr> <tr><td>3:</td><td>10.3</td><td style="text-align:right;">↙</td></tr> <tr><td>4:</td><td>9.9</td><td style="text-align:right;">↗</td></tr> </table> <table border="1" style="width:100%; border-collapse: collapse; margin-top: 10px;"> <tr> <td style="width:80%;">Serie</td> <td style="text-align:right;">37.0</td> </tr> <tr> <td>Total</td> <td style="text-align:right;">0.0</td> </tr> </table> | 1: | 9.9 | → | 2: | 9.8 | → | 3: | 10.3 | ↙ | 4: | 9.9 | ↗ | Serie | 37.0 | Total | 0.0 |
| 1: | 9.9 | → | | | | | | | | | | | | | | | |
| 2: | 9.8 | → | | | | | | | | | | | | | | | |
| 3: | 10.3 | ↙ | | | | | | | | | | | | | | | |
| 4: | 9.9 | ↗ | | | | | | | | | | | | | | | |
| Serie | 37.0 | | | | | | | | | | | | | | | | |
| Total | 0.0 | | | | | | | | | | | | | | | | |

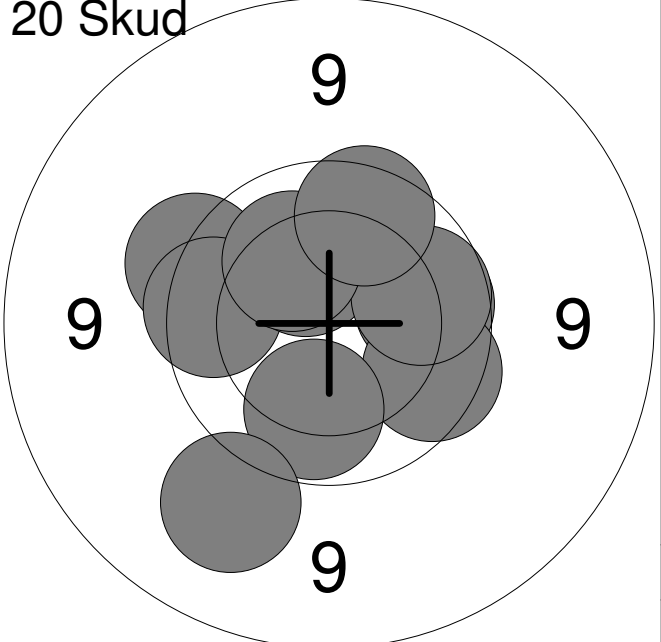
| | | | | | | | | | | | | | | | | | | | | | | | | | | | | | | | | | | | |
|---|--|----|-----|---|----|-----|---|----|------|---|----|-----|---|----|-----|---|----|------|---|----|-----|---|----|------|---|----|-----|---|-----|-----|---|-------|------|-------|------|
| <p>20 Skud</p>  | <table style="width:100%; border-collapse: collapse;"> <tr><td style="width:10%;">1:</td><td style="width:15%;">9.9</td><td style="width:10%; text-align:right;">→</td></tr> <tr><td>2:</td><td>9.8</td><td style="text-align:right;">↘</td></tr> <tr><td>3:</td><td>10.0</td><td style="text-align:right;">↓</td></tr> <tr><td>4:</td><td>9.6</td><td style="text-align:right;">↗</td></tr> <tr><td>5:</td><td>9.8</td><td style="text-align:right;">←</td></tr> <tr><td>6:</td><td>10.3</td><td style="text-align:right;">↗</td></tr> <tr><td>7:</td><td>9.9</td><td style="text-align:right;">→</td></tr> <tr><td>8:</td><td>10.2</td><td style="text-align:right;">↗</td></tr> <tr><td>9:</td><td>9.8</td><td style="text-align:right;">↗</td></tr> <tr><td>10:</td><td>9.3</td><td style="text-align:right;">↘</td></tr> </table> <table border="1" style="width:100%; border-collapse: collapse; margin-top: 10px;"> <tr> <td style="width:80%;">Serie</td> <td style="text-align:right;">93.0</td> </tr> <tr> <td>Total</td> <td style="text-align:right;">93.0</td> </tr> </table> | 1: | 9.9 | → | 2: | 9.8 | ↘ | 3: | 10.0 | ↓ | 4: | 9.6 | ↗ | 5: | 9.8 | ← | 6: | 10.3 | ↗ | 7: | 9.9 | → | 8: | 10.2 | ↗ | 9: | 9.8 | ↗ | 10: | 9.3 | ↘ | Serie | 93.0 | Total | 93.0 |
| 1: | 9.9 | → | | | | | | | | | | | | | | | | | | | | | | | | | | | | | | | | | |
| 2: | 9.8 | ↘ | | | | | | | | | | | | | | | | | | | | | | | | | | | | | | | | | |
| 3: | 10.0 | ↓ | | | | | | | | | | | | | | | | | | | | | | | | | | | | | | | | | |
| 4: | 9.6 | ↗ | | | | | | | | | | | | | | | | | | | | | | | | | | | | | | | | | |
| 5: | 9.8 | ← | | | | | | | | | | | | | | | | | | | | | | | | | | | | | | | | | |
| 6: | 10.3 | ↗ | | | | | | | | | | | | | | | | | | | | | | | | | | | | | | | | | |
| 7: | 9.9 | → | | | | | | | | | | | | | | | | | | | | | | | | | | | | | | | | | |
| 8: | 10.2 | ↗ | | | | | | | | | | | | | | | | | | | | | | | | | | | | | | | | | |
| 9: | 9.8 | ↗ | | | | | | | | | | | | | | | | | | | | | | | | | | | | | | | | | |
| 10: | 9.3 | ↘ | | | | | | | | | | | | | | | | | | | | | | | | | | | | | | | | | |
| Serie | 93.0 | | | | | | | | | | | | | | | | | | | | | | | | | | | | | | | | | | |
| Total | 93.0 | | | | | | | | | | | | | | | | | | | | | | | | | | | | | | | | | | |

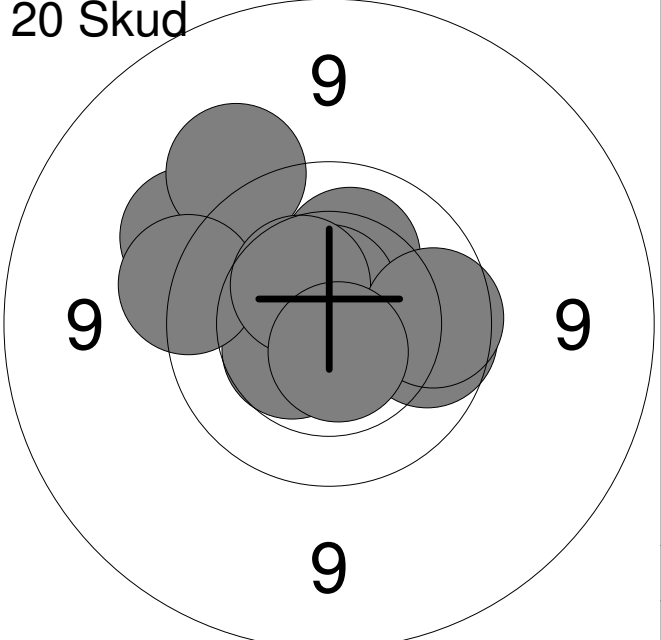
| | | | | | | | | | | | | | | | | | | | | | | | | | | | | | | | | | | | |
|--|--|-----|-----|---|-----|-----|---|-----|------|---|-----|-----|---|-----|-------|---|-----|------|---|-----|-----|---|-----|------|---|-----|-----|---|-----|-------|---|-------|------|-------|-------|
| <p>20 Skud</p>  | <table style="width:100%; border-collapse: collapse;"> <tr><td style="width:10%;">11:</td><td style="width:15%;">9.5</td><td style="width:10%; text-align:right;">↗</td></tr> <tr><td>12:</td><td>9.9</td><td style="text-align:right;">→</td></tr> <tr><td>13:</td><td>10.2</td><td style="text-align:right;">↗</td></tr> <tr><td>14:</td><td>9.4</td><td style="text-align:right;">↗</td></tr> <tr><td>15:</td><td>*10.6</td><td style="text-align:right;">↑</td></tr> <tr><td>16:</td><td>10.5</td><td style="text-align:right;">↙</td></tr> <tr><td>17:</td><td>9.6</td><td style="text-align:right;">↗</td></tr> <tr><td>18:</td><td>10.4</td><td style="text-align:right;">↗</td></tr> <tr><td>19:</td><td>9.9</td><td style="text-align:right;">→</td></tr> <tr><td>20:</td><td>*10.6</td><td style="text-align:right;">↘</td></tr> </table> <table border="1" style="width:100%; border-collapse: collapse; margin-top: 10px;"> <tr> <td style="width:80%;">Serie</td> <td style="text-align:right;">95.0</td> </tr> <tr> <td>Total</td> <td style="text-align:right;">188.0</td> </tr> </table> | 11: | 9.5 | ↗ | 12: | 9.9 | → | 13: | 10.2 | ↗ | 14: | 9.4 | ↗ | 15: | *10.6 | ↑ | 16: | 10.5 | ↙ | 17: | 9.6 | ↗ | 18: | 10.4 | ↗ | 19: | 9.9 | → | 20: | *10.6 | ↘ | Serie | 95.0 | Total | 188.0 |
| 11: | 9.5 | ↗ | | | | | | | | | | | | | | | | | | | | | | | | | | | | | | | | | |
| 12: | 9.9 | → | | | | | | | | | | | | | | | | | | | | | | | | | | | | | | | | | |
| 13: | 10.2 | ↗ | | | | | | | | | | | | | | | | | | | | | | | | | | | | | | | | | |
| 14: | 9.4 | ↗ | | | | | | | | | | | | | | | | | | | | | | | | | | | | | | | | | |
| 15: | *10.6 | ↑ | | | | | | | | | | | | | | | | | | | | | | | | | | | | | | | | | |
| 16: | 10.5 | ↙ | | | | | | | | | | | | | | | | | | | | | | | | | | | | | | | | | |
| 17: | 9.6 | ↗ | | | | | | | | | | | | | | | | | | | | | | | | | | | | | | | | | |
| 18: | 10.4 | ↗ | | | | | | | | | | | | | | | | | | | | | | | | | | | | | | | | | |
| 19: | 9.9 | → | | | | | | | | | | | | | | | | | | | | | | | | | | | | | | | | | |
| 20: | *10.6 | ↘ | | | | | | | | | | | | | | | | | | | | | | | | | | | | | | | | | |
| Serie | 95.0 | | | | | | | | | | | | | | | | | | | | | | | | | | | | | | | | | | |
| Total | 188.0 | | | | | | | | | | | | | | | | | | | | | | | | | | | | | | | | | | |

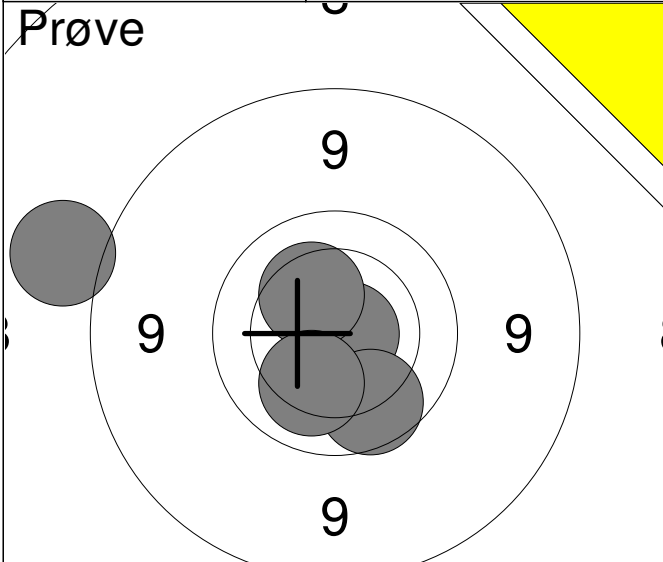
| | | | | | | | | | | | | | | | | |
|---|--|-------|------|-------|----|-------|---|----|------|---|----|-----|---|----|------|---|
| <p>Prøve</p>  | <table style="width:100%; border-collapse: collapse;"> <tr><td style="width:10%;">1:</td><td style="width:70%;">8.5</td><td style="width:20%; text-align:center;">↖</td></tr> <tr><td>2:</td><td>*10.8</td><td style="text-align:center;">→</td></tr> <tr><td>3:</td><td>10.3</td><td style="text-align:center;">↗</td></tr> <tr><td>4:</td><td>9.9</td><td style="text-align:center;">↘</td></tr> <tr><td>5:</td><td>10.2</td><td style="text-align:center;">↙</td></tr> </table> | 1: | 8.5 | ↖ | 2: | *10.8 | → | 3: | 10.3 | ↗ | 4: | 9.9 | ↘ | 5: | 10.2 | ↙ |
| 1: | 8.5 | ↖ | | | | | | | | | | | | | | |
| 2: | *10.8 | → | | | | | | | | | | | | | | |
| 3: | 10.3 | ↗ | | | | | | | | | | | | | | |
| 4: | 9.9 | ↘ | | | | | | | | | | | | | | |
| 5: | 10.2 | ↙ | | | | | | | | | | | | | | |
| <table style="width:100%; border-collapse: collapse;"> <tr> <td style="width:80%;">Serie</td> <td style="text-align:right;">47.0</td> </tr> <tr> <td colspan="2" style="border-top: 1px solid black;">Total</td> </tr> <tr> <td colspan="2" style="text-align:right;">0.0</td> </tr> </table> | | Serie | 47.0 | Total | | 0.0 | | | | | | | | | | |
| Serie | 47.0 | | | | | | | | | | | | | | | |
| Total | | | | | | | | | | | | | | | | |
| 0.0 | | | | | | | | | | | | | | | | |

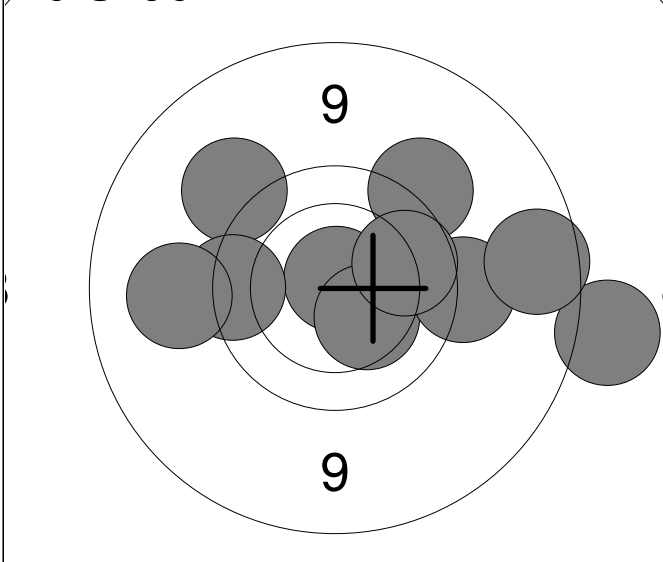
| | | | | | | | | | | | | | | | | | | | | | | | | | | | | | | | |
|--|--|-------|-------|-------|----|------|---|----|-----|---|----|-----|---|----|-----|---|----|-----|---|----|-----|---|----|-----|---|----|-----|---|-----|-----|---|
| <p>20 Skud</p>  | <table style="width:100%; border-collapse: collapse;"> <tr><td style="width:10%;">1:</td><td style="width:70%;">*10.8</td><td style="width:20%; text-align:center;">↑</td></tr> <tr><td>2:</td><td>10.3</td><td style="text-align:center;">↘</td></tr> <tr><td>3:</td><td>9.4</td><td style="text-align:center;">↗</td></tr> <tr><td>4:</td><td>9.5</td><td style="text-align:center;">→</td></tr> <tr><td>5:</td><td>8.5</td><td style="text-align:center;">→</td></tr> <tr><td>6:</td><td>9.7</td><td style="text-align:center;">←</td></tr> <tr><td>7:</td><td>8.9</td><td style="text-align:center;">→</td></tr> <tr><td>8:</td><td>9.5</td><td style="text-align:center;">↗</td></tr> <tr><td>9:</td><td>9.9</td><td style="text-align:center;">→</td></tr> <tr><td>10:</td><td>9.3</td><td style="text-align:center;">←</td></tr> </table> | 1: | *10.8 | ↑ | 2: | 10.3 | ↘ | 3: | 9.4 | ↗ | 4: | 9.5 | → | 5: | 8.5 | → | 6: | 9.7 | ← | 7: | 8.9 | → | 8: | 9.5 | ↗ | 9: | 9.9 | → | 10: | 9.3 | ← |
| 1: | *10.8 | ↑ | | | | | | | | | | | | | | | | | | | | | | | | | | | | | |
| 2: | 10.3 | ↘ | | | | | | | | | | | | | | | | | | | | | | | | | | | | | |
| 3: | 9.4 | ↗ | | | | | | | | | | | | | | | | | | | | | | | | | | | | | |
| 4: | 9.5 | → | | | | | | | | | | | | | | | | | | | | | | | | | | | | | |
| 5: | 8.5 | → | | | | | | | | | | | | | | | | | | | | | | | | | | | | | |
| 6: | 9.7 | ← | | | | | | | | | | | | | | | | | | | | | | | | | | | | | |
| 7: | 8.9 | → | | | | | | | | | | | | | | | | | | | | | | | | | | | | | |
| 8: | 9.5 | ↗ | | | | | | | | | | | | | | | | | | | | | | | | | | | | | |
| 9: | 9.9 | → | | | | | | | | | | | | | | | | | | | | | | | | | | | | | |
| 10: | 9.3 | ← | | | | | | | | | | | | | | | | | | | | | | | | | | | | | |
| <table style="width:100%; border-collapse: collapse;"> <tr> <td style="width:80%;">Serie</td> <td style="text-align:right;">90.0</td> </tr> <tr> <td colspan="2" style="border-top: 1px solid black;">Total</td> </tr> <tr> <td colspan="2" style="text-align:right;">90.0</td> </tr> </table> | | Serie | 90.0 | Total | | 90.0 | | | | | | | | | | | | | | | | | | | | | | | | | |
| Serie | 90.0 | | | | | | | | | | | | | | | | | | | | | | | | | | | | | | |
| Total | | | | | | | | | | | | | | | | | | | | | | | | | | | | | | | |
| 90.0 | | | | | | | | | | | | | | | | | | | | | | | | | | | | | | | |

| | | | | | | | | | | | | | | | | | | | | | | | | | | | | | | | |
|---|--|-------|------|-------|-----|-------|---|-----|-----|---|-----|-----|---|-----|------|---|-----|-----|---|-----|-----|---|-----|-----|---|-----|-----|---|-----|-----|---|
| <p>20 Skud</p>  | <table style="width:100%; border-collapse: collapse;"> <tr><td style="width:10%;">11:</td><td style="width:70%;">9.5</td><td style="width:20%; text-align:center;">→</td></tr> <tr><td>12:</td><td>10.0</td><td style="text-align:center;">↑</td></tr> <tr><td>13:</td><td>9.7</td><td style="text-align:center;">↑</td></tr> <tr><td>14:</td><td>9.5</td><td style="text-align:center;">→</td></tr> <tr><td>15:</td><td>10.4</td><td style="text-align:center;">↘</td></tr> <tr><td>16:</td><td>9.7</td><td style="text-align:center;">←</td></tr> <tr><td>17:</td><td>9.8</td><td style="text-align:center;">↑</td></tr> <tr><td>18:</td><td>9.3</td><td style="text-align:center;">↘</td></tr> <tr><td>19:</td><td>9.6</td><td style="text-align:center;">→</td></tr> <tr><td>20:</td><td>9.9</td><td style="text-align:center;">↗</td></tr> </table> | 11: | 9.5 | → | 12: | 10.0 | ↑ | 13: | 9.7 | ↑ | 14: | 9.5 | → | 15: | 10.4 | ↘ | 16: | 9.7 | ← | 17: | 9.8 | ↑ | 18: | 9.3 | ↘ | 19: | 9.6 | → | 20: | 9.9 | ↗ |
| 11: | 9.5 | → | | | | | | | | | | | | | | | | | | | | | | | | | | | | | |
| 12: | 10.0 | ↑ | | | | | | | | | | | | | | | | | | | | | | | | | | | | | |
| 13: | 9.7 | ↑ | | | | | | | | | | | | | | | | | | | | | | | | | | | | | |
| 14: | 9.5 | → | | | | | | | | | | | | | | | | | | | | | | | | | | | | | |
| 15: | 10.4 | ↘ | | | | | | | | | | | | | | | | | | | | | | | | | | | | | |
| 16: | 9.7 | ← | | | | | | | | | | | | | | | | | | | | | | | | | | | | | |
| 17: | 9.8 | ↑ | | | | | | | | | | | | | | | | | | | | | | | | | | | | | |
| 18: | 9.3 | ↘ | | | | | | | | | | | | | | | | | | | | | | | | | | | | | |
| 19: | 9.6 | → | | | | | | | | | | | | | | | | | | | | | | | | | | | | | |
| 20: | 9.9 | ↗ | | | | | | | | | | | | | | | | | | | | | | | | | | | | | |
| <table style="width:100%; border-collapse: collapse;"> <tr> <td style="width:80%;">Serie</td> <td style="text-align:right;">92.0</td> </tr> <tr> <td colspan="2" style="border-top: 1px solid black;">Total</td> </tr> <tr> <td colspan="2" style="text-align:right;">182.0</td> </tr> </table> | | Serie | 92.0 | Total | | 182.0 | | | | | | | | | | | | | | | | | | | | | | | | | |
| Serie | 92.0 | | | | | | | | | | | | | | | | | | | | | | | | | | | | | | |
| Total | | | | | | | | | | | | | | | | | | | | | | | | | | | | | | | |
| 182.0 | | | | | | | | | | | | | | | | | | | | | | | | | | | | | | | |

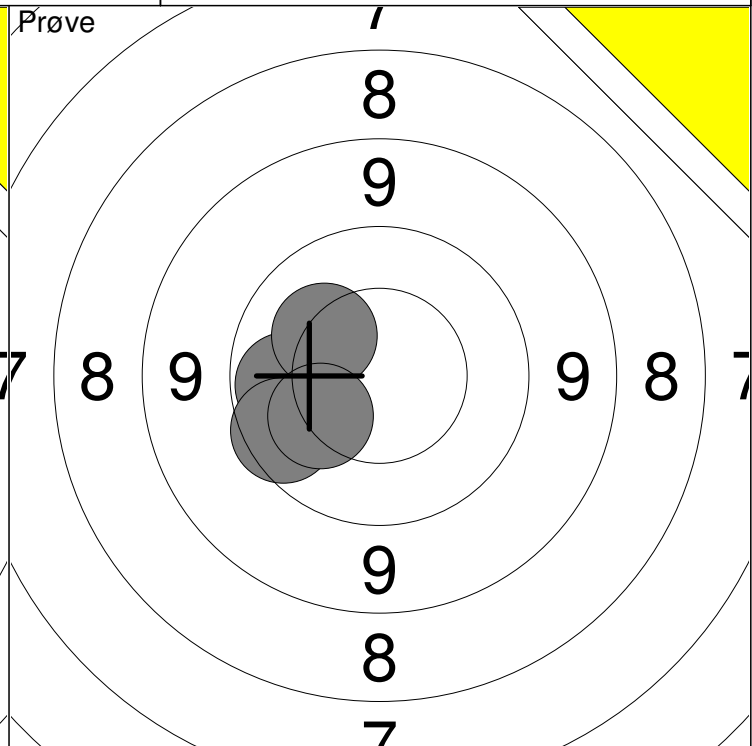
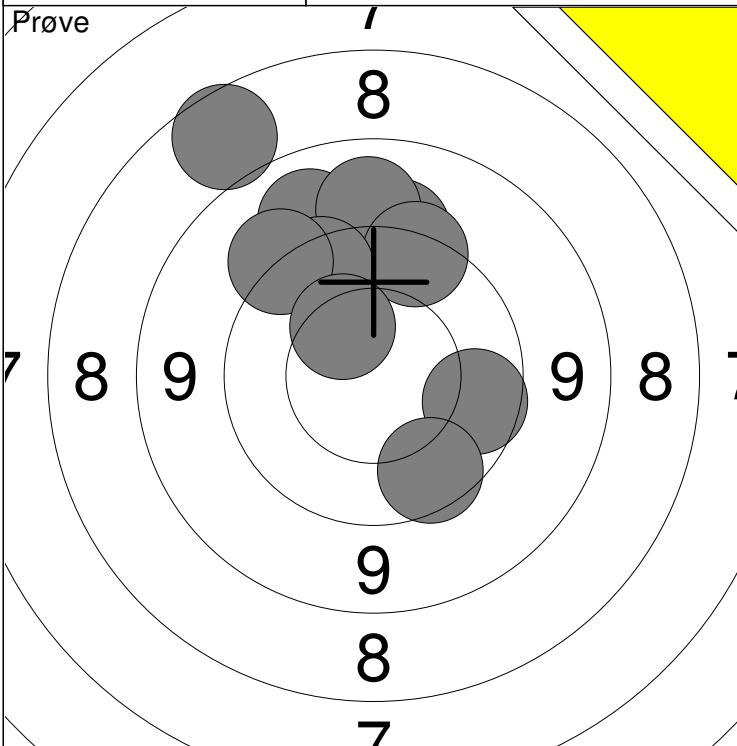

| | | | |
|----------|------------|-------|------|
| 1: 7.9 ↗ | 6: 9.7 ↗ | Serie | 89.0 |
| 2: 9.2 ↗ | 7: 9.4 ↗ | | |
| 3: 9.4 ↑ | 8: 9.9 → | Total | 0.0 |
| 4: 9.2 ↑ | 9: 9.8 ↘ | | |
| 5: 9.6 ↑ | 10: 10.4 ↗ | | |

| | | |
|------------|-------|------|
| 11: 10.0 ← | Serie | 39.0 |
| 12: 9.8 ↙ | | |
| 13: 10.2 ↘ | Total | 0.0 |
| 14: 10.2 ↙ | | |

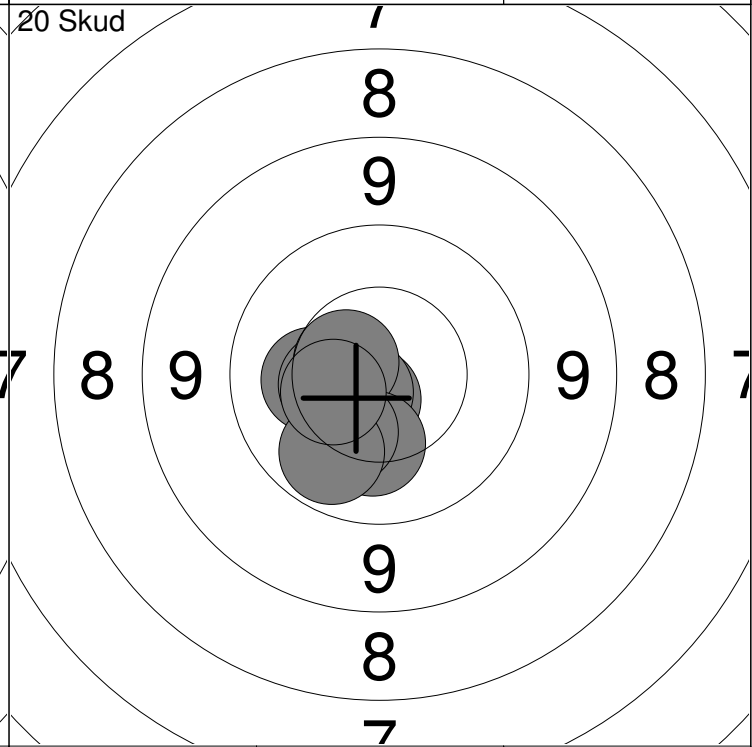
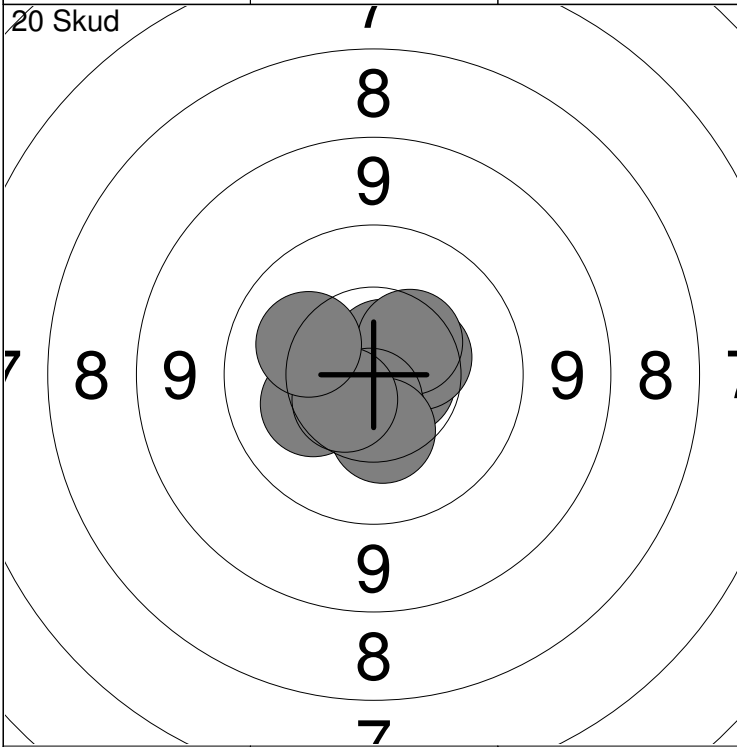

| | | | |
|------------|------------|-------|-------|
| 1: *10.6 → | 6: 10.5 ↓ | Serie | 100.0 |
| 2: *10.7 ↗ | 7: *10.7 ↓ | | |
| 3: 10.4 → | 8: 10.4 ↓ | Total | 100.0 |
| 4: 10.4 ↗ | 9: 10.6 ↙ | | |
| 5: 10.3 ↙ | 10: 10.2 ↖ | | |

| | | | |
|-------------|-------------|-------|-------|
| 11: 10.3 ← | 16: *10.6 ↖ | Serie | 100.0 |
| 12: 10.5 ↖ | 17: 10.2 ↓ | | |
| 13: *10.7 ↙ | 18: 10.3 ↙ | Total | 200.0 |
| 14: *10.7 ↙ | 19: 10.0 ↙ | | |
| 15: 10.4 ← | 20: 10.4 ↖ | | |

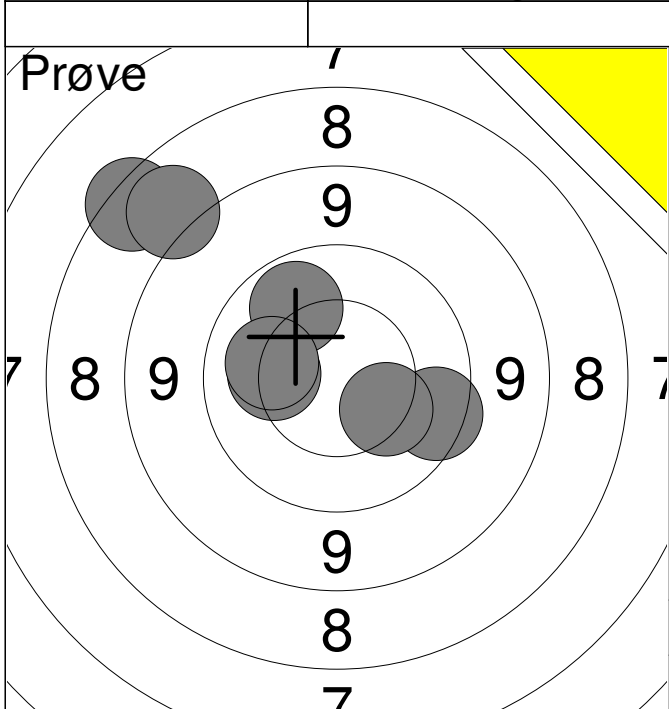

| | | |
|-------|------|------|
| 1: | 7.6 | ↗ |
| 2: | 8.1 | ↗ |
| 3: | 10.2 | ← |
| 4: | 10.0 | ↗ |
| 5: | 10.2 | ← |
| 6: | 9.7 | ↘ |
| 7: | 10.3 | ↘ |
| Serie | | 64.0 |
| Total | | 0.0 |

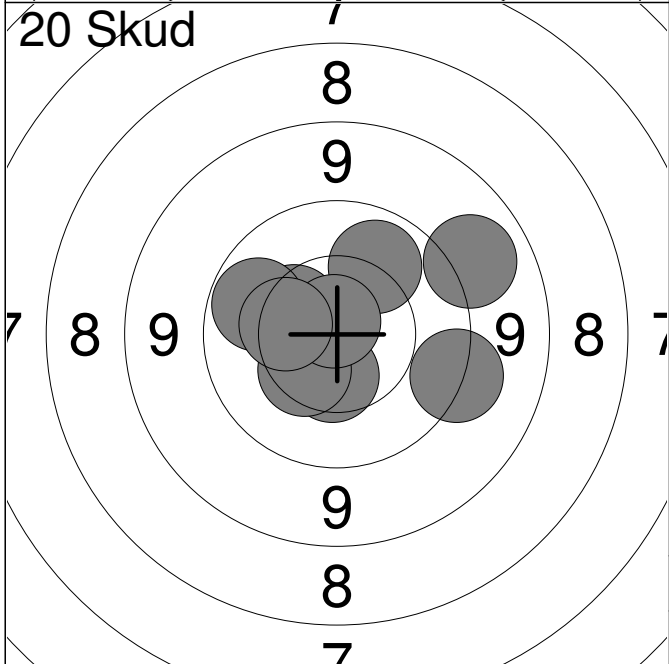

| | | |
|-------|-------|------|
| 1: | 10.6 | ↙ |
| 2: | 10.5 | ↘ |
| 3: | 10.4 | ↗ |
| 4: | 9.4 | ↘ |
| 5: | 10.1 | ↗ |
| 6: | 10.4 | ↙ |
| 7: | 9.1 | ↗ |
| 8: | 10.0 | ← |
| 9: | *10.8 | ↗ |
| 10: | 10.3 | ← |
| Serie | | 98.0 |
| Total | | 98.0 |

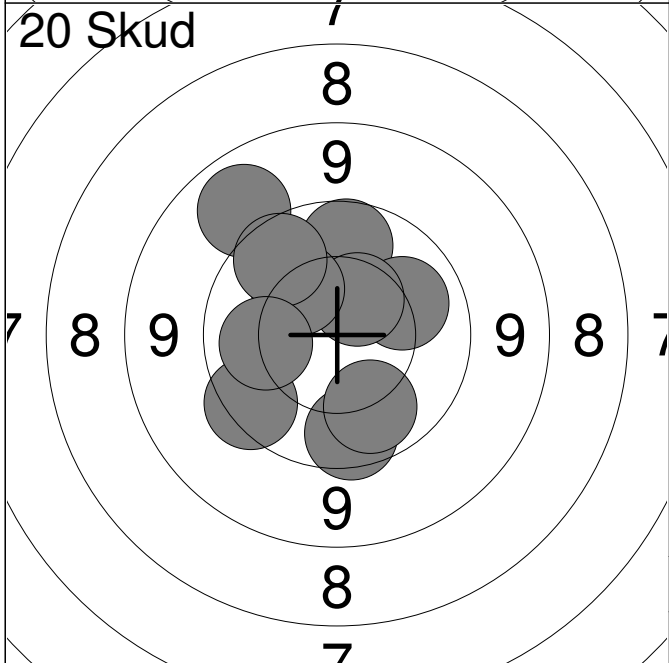

| | | |
|-------|------|-------|
| 11: | 9.8 | ↘ |
| 12: | 10.0 | ↘ |
| 13: | 9.9 | ↗ |
| 14: | 9.1 | ↗ |
| 15: | 10.1 | ↗ |
| 16: | 10.5 | ↗ |
| 17: | 9.7 | ↙ |
| 18: | 10.2 | ↗ |
| 19: | 9.8 | ↗ |
| 20: | 10.1 | ← |
| Serie | | 95.0 |
| Total | | 193.0 |

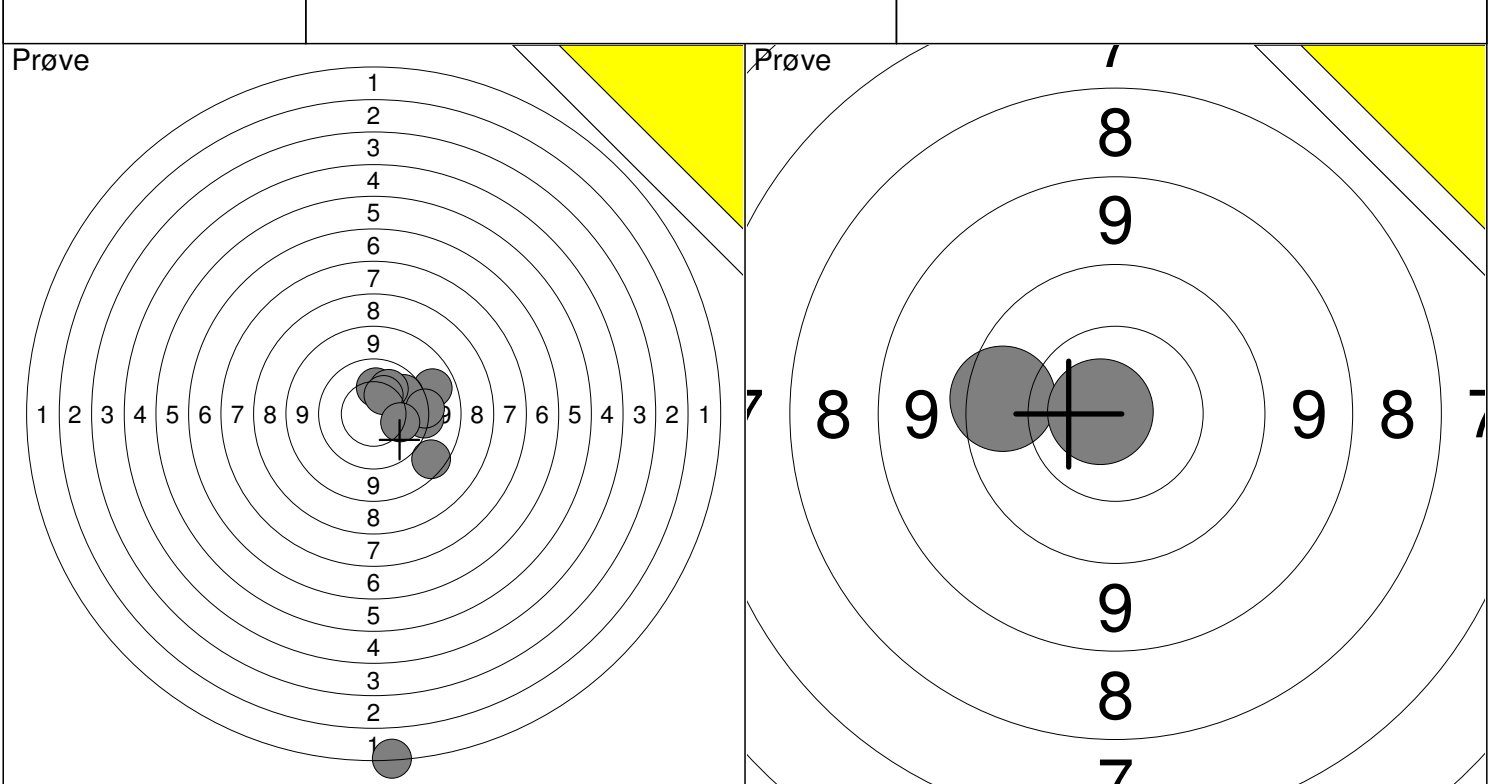

| | | | | | | | | |
|----------|------------|-------|-------|------|-------------|-----|-------|------|
| 1: 9.1 → | 6: 10.2 ↑ | | Serie | 84.0 | 11: 9.8 ← | | Serie | 19.0 |
| 2: 0.0 ↓ | 7: 9.5 → | | | | 12: *10.8 ← | | | |
| 3: 8.8 ↘ | 8: 10.1 ↗ | Total | 0.0 | 0.0 | Total | 0.0 | | |
| 4: 9.5 → | 9: 10.4 ↗ | | | | | | | |
| 5: 9.9 ↗ | 10: 10.2 → | | | | | | | |

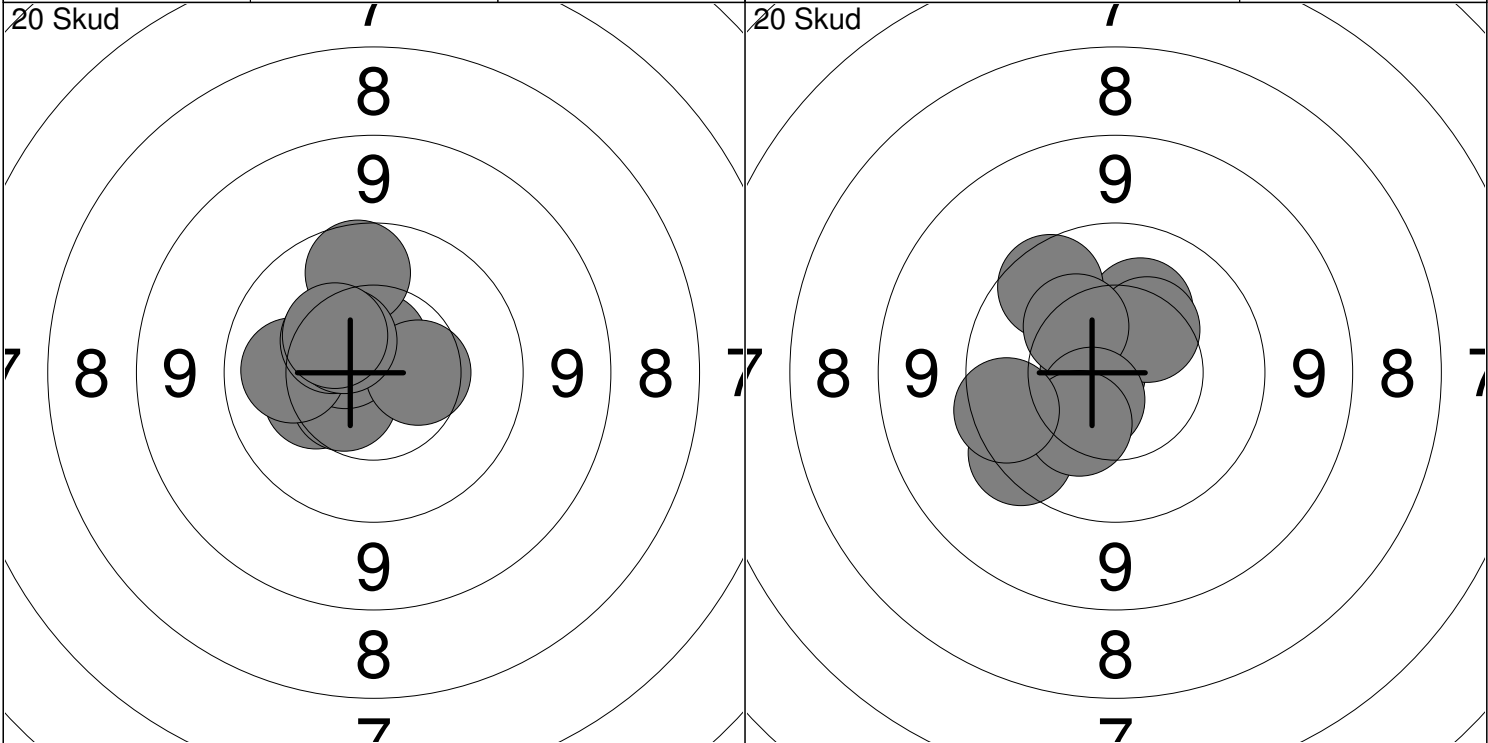

| | | | | | | | | | |
|------------|------------|-------|-------|------|-------------|------------|-------|-------|------|
| 1: 10.3 ← | 6: 10.1 ← | | Serie | 99.0 | 11: *10.6 ↑ | 16: 10.3 ↖ | | Serie | 97.0 |
| 2: 10.5 ↙ | 7: 10.4 ↗ | | | | 12: *10.7 ← | 17: 9.6 ↘ | | | |
| 3: *10.7 ↑ | 8: 9.9 ↑ | Total | 99.0 | 99.0 | 13: 10.3 ↗ | 18: 10.6 ↘ | Total | 196.0 | |
| 4: *10.6 ↖ | 9: 10.5 ↗ | | | | 14: 9.8 ↖ | 19: 10.3 ↘ | | | |
| 5: 10.5 → | 10: 10.4 ↖ | | | | | | | | |

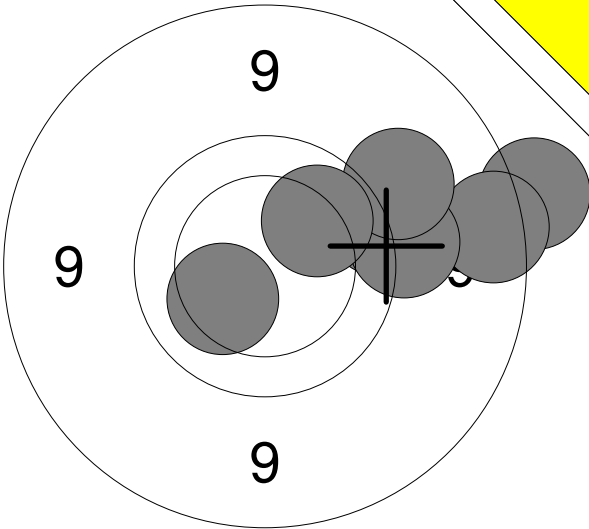
| | | | | | | | | | | | | | | | | | | | | | | |
|---|---|-------|------|-------|-----|-----|---|----|-----|---|----|-----|---|----|-----|---|----|------|---|----|------|---|
| <p>Prøve</p>  | <table style="width:100%; border-collapse: collapse;"> <tr><td style="width:10%;">1:</td><td style="width:15%;">8.6</td><td style="width:10%; text-align: center;">→</td></tr> <tr><td>2:</td><td>8.8</td><td style="text-align: center;">→</td></tr> <tr><td>3:</td><td>9.6</td><td style="text-align: center;">→</td></tr> <tr><td>4:</td><td>9.4</td><td style="text-align: center;">→</td></tr> <tr><td>5:</td><td>9.3</td><td style="text-align: center;">↗</td></tr> <tr><td>6:</td><td>10.0</td><td style="text-align: center;">↗</td></tr> <tr><td>7:</td><td>10.2</td><td style="text-align: center;">↘</td></tr> </table> | 1: | 8.6 | → | 2: | 8.8 | → | 3: | 9.6 | → | 4: | 9.4 | → | 5: | 9.3 | ↗ | 6: | 10.0 | ↗ | 7: | 10.2 | ↘ |
| 1: | 8.6 | → | | | | | | | | | | | | | | | | | | | | |
| 2: | 8.8 | → | | | | | | | | | | | | | | | | | | | | |
| 3: | 9.6 | → | | | | | | | | | | | | | | | | | | | | |
| 4: | 9.4 | → | | | | | | | | | | | | | | | | | | | | |
| 5: | 9.3 | ↗ | | | | | | | | | | | | | | | | | | | | |
| 6: | 10.0 | ↗ | | | | | | | | | | | | | | | | | | | | |
| 7: | 10.2 | ↘ | | | | | | | | | | | | | | | | | | | | |
| <table style="width:100%; border-collapse: collapse;"> <tr> <td style="width:80%;">Serie</td> <td style="text-align: right;">63.0</td> </tr> <tr> <td>Total</td> <td style="text-align: right;">0.0</td> </tr> </table> | | Serie | 63.0 | Total | 0.0 | | | | | | | | | | | | | | | | | |
| Serie | 63.0 | | | | | | | | | | | | | | | | | | | | | |
| Total | 0.0 | | | | | | | | | | | | | | | | | | | | | |

| | | | | | | | | | | | | | | | | | | | | | | | | | | | | | | | |
|--|---|-------|------|-------|------|------|---|----|------|---|----|------|---|----|------|---|----|-----|---|----|-------|---|----|-------|---|----|------|---|-----|------|---|
| <p>20 Skud</p>  | <table style="width:100%; border-collapse: collapse;"> <tr><td style="width:10%;">1:</td><td style="width:15%;">9.6</td><td style="width:10%; text-align: center;">↓</td></tr> <tr><td>2:</td><td>10.5</td><td style="text-align: center;">↓</td></tr> <tr><td>3:</td><td>10.5</td><td style="text-align: center;">↓</td></tr> <tr><td>4:</td><td>10.5</td><td style="text-align: center;">→</td></tr> <tr><td>5:</td><td>10.1</td><td style="text-align: center;">↘</td></tr> <tr><td>6:</td><td>9.8</td><td style="text-align: center;">←</td></tr> <tr><td>7:</td><td>*10.8</td><td style="text-align: center;">↗</td></tr> <tr><td>8:</td><td>*10.7</td><td style="text-align: center;">↓</td></tr> <tr><td>9:</td><td>10.4</td><td style="text-align: center;">↑</td></tr> <tr><td>10:</td><td>10.0</td><td style="text-align: center;">↗</td></tr> </table> | 1: | 9.6 | ↓ | 2: | 10.5 | ↓ | 3: | 10.5 | ↓ | 4: | 10.5 | → | 5: | 10.1 | ↘ | 6: | 9.8 | ← | 7: | *10.8 | ↗ | 8: | *10.7 | ↓ | 9: | 10.4 | ↑ | 10: | 10.0 | ↗ |
| 1: | 9.6 | ↓ | | | | | | | | | | | | | | | | | | | | | | | | | | | | | |
| 2: | 10.5 | ↓ | | | | | | | | | | | | | | | | | | | | | | | | | | | | | |
| 3: | 10.5 | ↓ | | | | | | | | | | | | | | | | | | | | | | | | | | | | | |
| 4: | 10.5 | → | | | | | | | | | | | | | | | | | | | | | | | | | | | | | |
| 5: | 10.1 | ↘ | | | | | | | | | | | | | | | | | | | | | | | | | | | | | |
| 6: | 9.8 | ← | | | | | | | | | | | | | | | | | | | | | | | | | | | | | |
| 7: | *10.8 | ↗ | | | | | | | | | | | | | | | | | | | | | | | | | | | | | |
| 8: | *10.7 | ↓ | | | | | | | | | | | | | | | | | | | | | | | | | | | | | |
| 9: | 10.4 | ↑ | | | | | | | | | | | | | | | | | | | | | | | | | | | | | |
| 10: | 10.0 | ↗ | | | | | | | | | | | | | | | | | | | | | | | | | | | | | |
| <table style="width:100%; border-collapse: collapse;"> <tr> <td style="width:80%;">Serie</td> <td style="text-align: right;">98.0</td> </tr> <tr> <td>Total</td> <td style="text-align: right;">98.0</td> </tr> </table> | | Serie | 98.0 | Total | 98.0 | | | | | | | | | | | | | | | | | | | | | | | | | | |
| Serie | 98.0 | | | | | | | | | | | | | | | | | | | | | | | | | | | | | | |
| Total | 98.0 | | | | | | | | | | | | | | | | | | | | | | | | | | | | | | |

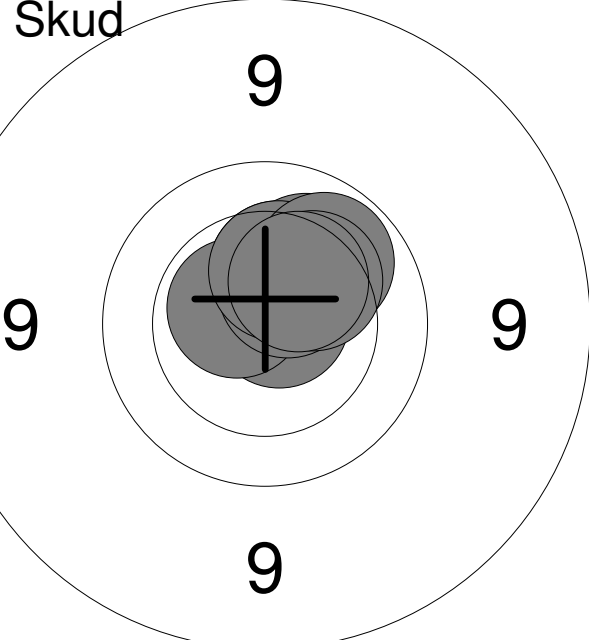
| | | | | | | | | | | | | | | | | | | | | | | | | | | | | | | | |
|--|---|-------|-------|-------|-------|-------|---|-----|------|---|-----|------|---|-----|-------|---|-----|------|---|-----|------|---|-----|------|---|-----|------|---|-----|------|---|
| <p>20 Skud</p>  | <table style="width:100%; border-collapse: collapse;"> <tr><td style="width:10%;">11:</td><td style="width:15%;">*10.8</td><td style="width:10%; text-align: center;">↗</td></tr> <tr><td>12:</td><td>*10.8</td><td style="text-align: center;">→</td></tr> <tr><td>13:</td><td>10.4</td><td style="text-align: center;">↑</td></tr> <tr><td>14:</td><td>10.2</td><td style="text-align: center;">↗</td></tr> <tr><td>15:</td><td>*10.6</td><td style="text-align: center;">↘</td></tr> <tr><td>16:</td><td>10.5</td><td style="text-align: center;">↗</td></tr> <tr><td>17:</td><td>10.4</td><td style="text-align: center;">↑</td></tr> <tr><td>18:</td><td>10.0</td><td style="text-align: center;">↗</td></tr> <tr><td>19:</td><td>10.3</td><td style="text-align: center;">↗</td></tr> <tr><td>20:</td><td>10.4</td><td style="text-align: center;">↗</td></tr> </table> | 11: | *10.8 | ↗ | 12: | *10.8 | → | 13: | 10.4 | ↑ | 14: | 10.2 | ↗ | 15: | *10.6 | ↘ | 16: | 10.5 | ↗ | 17: | 10.4 | ↑ | 18: | 10.0 | ↗ | 19: | 10.3 | ↗ | 20: | 10.4 | ↗ |
| 11: | *10.8 | ↗ | | | | | | | | | | | | | | | | | | | | | | | | | | | | | |
| 12: | *10.8 | → | | | | | | | | | | | | | | | | | | | | | | | | | | | | | |
| 13: | 10.4 | ↑ | | | | | | | | | | | | | | | | | | | | | | | | | | | | | |
| 14: | 10.2 | ↗ | | | | | | | | | | | | | | | | | | | | | | | | | | | | | |
| 15: | *10.6 | ↘ | | | | | | | | | | | | | | | | | | | | | | | | | | | | | |
| 16: | 10.5 | ↗ | | | | | | | | | | | | | | | | | | | | | | | | | | | | | |
| 17: | 10.4 | ↑ | | | | | | | | | | | | | | | | | | | | | | | | | | | | | |
| 18: | 10.0 | ↗ | | | | | | | | | | | | | | | | | | | | | | | | | | | | | |
| 19: | 10.3 | ↗ | | | | | | | | | | | | | | | | | | | | | | | | | | | | | |
| 20: | 10.4 | ↗ | | | | | | | | | | | | | | | | | | | | | | | | | | | | | |
| <table style="width:100%; border-collapse: collapse;"> <tr> <td style="width:80%;">Serie</td> <td style="text-align: right;">100.0</td> </tr> <tr> <td>Total</td> <td style="text-align: right;">198.0</td> </tr> </table> | | Serie | 100.0 | Total | 198.0 | | | | | | | | | | | | | | | | | | | | | | | | | | |
| Serie | 100.0 | | | | | | | | | | | | | | | | | | | | | | | | | | | | | | |
| Total | 198.0 | | | | | | | | | | | | | | | | | | | | | | | | | | | | | | |

| | | | | | | | | | | | | | | | | | | | | | | | |
|---------------------|--|----|-----|---|----|------|---|----|------|---|----|-------|---|----|------|---|----|-------|---|-------|------|-------|-----|
| <p>Prøve</p> | <table style="width:100%; border-collapse: collapse;"> <tr><td style="text-align: right;">1:</td><td style="text-align: right;">9.8</td><td style="text-align: right;">↗</td></tr> <tr><td style="text-align: right;">2:</td><td style="text-align: right;">10.5</td><td style="text-align: right;">→</td></tr> <tr><td style="text-align: right;">3:</td><td style="text-align: right;">10.3</td><td style="text-align: right;">↗</td></tr> <tr><td style="text-align: right;">4:</td><td style="text-align: right;">*10.5</td><td style="text-align: right;">↗</td></tr> <tr><td style="text-align: right;">5:</td><td style="text-align: right;">10.1</td><td style="text-align: right;">←</td></tr> <tr><td style="text-align: right;">6:</td><td style="text-align: right;">*10.7</td><td style="text-align: right;">↗</td></tr> </table> <table border="1" style="width:100%; border-collapse: collapse; margin-top: 5px;"> <tr> <td style="width:80%;">Serie</td> <td style="text-align: right;">59.0</td> </tr> <tr> <td>Total</td> <td style="text-align: right;">0.0</td> </tr> </table> | 1: | 9.8 | ↗ | 2: | 10.5 | → | 3: | 10.3 | ↗ | 4: | *10.5 | ↗ | 5: | 10.1 | ← | 6: | *10.7 | ↗ | Serie | 59.0 | Total | 0.0 |
| 1: | 9.8 | ↗ | | | | | | | | | | | | | | | | | | | | | |
| 2: | 10.5 | → | | | | | | | | | | | | | | | | | | | | | |
| 3: | 10.3 | ↗ | | | | | | | | | | | | | | | | | | | | | |
| 4: | *10.5 | ↗ | | | | | | | | | | | | | | | | | | | | | |
| 5: | 10.1 | ← | | | | | | | | | | | | | | | | | | | | | |
| 6: | *10.7 | ↗ | | | | | | | | | | | | | | | | | | | | | |
| Serie | 59.0 | | | | | | | | | | | | | | | | | | | | | | |
| Total | 0.0 | | | | | | | | | | | | | | | | | | | | | | |

| | | | | | | | | | | | | | | | | | | | | | | | | | | | | | | | | | | | |
|-----------------------|---|----|-----|---|----|------|---|----|-------|---|----|------|---|----|------|---|----|-----|---|----|------|---|----|-------|---|----|-----|---|-----|-------|---|-------|------|-------|------|
| <p>20 Skud</p> | <table style="width:100%; border-collapse: collapse;"> <tr><td style="text-align: right;">1:</td><td style="text-align: right;">9.8</td><td style="text-align: right;">↘</td></tr> <tr><td style="text-align: right;">2:</td><td style="text-align: right;">10.1</td><td style="text-align: right;">→</td></tr> <tr><td style="text-align: right;">3:</td><td style="text-align: right;">*10.5</td><td style="text-align: right;">←</td></tr> <tr><td style="text-align: right;">4:</td><td style="text-align: right;">10.1</td><td style="text-align: right;">←</td></tr> <tr><td style="text-align: right;">5:</td><td style="text-align: right;">10.1</td><td style="text-align: right;">→</td></tr> <tr><td style="text-align: right;">6:</td><td style="text-align: right;">9.7</td><td style="text-align: right;">←</td></tr> <tr><td style="text-align: right;">7:</td><td style="text-align: right;">10.0</td><td style="text-align: right;">↘</td></tr> <tr><td style="text-align: right;">8:</td><td style="text-align: right;">*10.9</td><td style="text-align: right;">↘</td></tr> <tr><td style="text-align: right;">9:</td><td style="text-align: right;">9.9</td><td style="text-align: right;">←</td></tr> <tr><td style="text-align: right;">10:</td><td style="text-align: right;">*10.6</td><td style="text-align: right;">←</td></tr> </table> <table border="1" style="width:100%; border-collapse: collapse; margin-top: 5px;"> <tr> <td style="width:80%;">Serie</td> <td style="text-align: right;">97.0</td> </tr> <tr> <td>Total</td> <td style="text-align: right;">97.0</td> </tr> </table> | 1: | 9.8 | ↘ | 2: | 10.1 | → | 3: | *10.5 | ← | 4: | 10.1 | ← | 5: | 10.1 | → | 6: | 9.7 | ← | 7: | 10.0 | ↘ | 8: | *10.9 | ↘ | 9: | 9.9 | ← | 10: | *10.6 | ← | Serie | 97.0 | Total | 97.0 |
| 1: | 9.8 | ↘ | | | | | | | | | | | | | | | | | | | | | | | | | | | | | | | | | |
| 2: | 10.1 | → | | | | | | | | | | | | | | | | | | | | | | | | | | | | | | | | | |
| 3: | *10.5 | ← | | | | | | | | | | | | | | | | | | | | | | | | | | | | | | | | | |
| 4: | 10.1 | ← | | | | | | | | | | | | | | | | | | | | | | | | | | | | | | | | | |
| 5: | 10.1 | → | | | | | | | | | | | | | | | | | | | | | | | | | | | | | | | | | |
| 6: | 9.7 | ← | | | | | | | | | | | | | | | | | | | | | | | | | | | | | | | | | |
| 7: | 10.0 | ↘ | | | | | | | | | | | | | | | | | | | | | | | | | | | | | | | | | |
| 8: | *10.9 | ↘ | | | | | | | | | | | | | | | | | | | | | | | | | | | | | | | | | |
| 9: | 9.9 | ← | | | | | | | | | | | | | | | | | | | | | | | | | | | | | | | | | |
| 10: | *10.6 | ← | | | | | | | | | | | | | | | | | | | | | | | | | | | | | | | | | |
| Serie | 97.0 | | | | | | | | | | | | | | | | | | | | | | | | | | | | | | | | | | |
| Total | 97.0 | | | | | | | | | | | | | | | | | | | | | | | | | | | | | | | | | | |

| | | | | | | | | | | | | | | | | | | | | | | | | | | | | | | | | | | | |
|-----------------------|---|-----|-------|---|-----|-----|---|-----|-------|---|-----|-------|---|-----|------|---|-----|-----|---|-----|------|---|-----|------|---|-----|------|---|-----|-------|---|-------|------|-------|-------|
| <p>20 Skud</p> | <table style="width:100%; border-collapse: collapse;"> <tr><td style="text-align: right;">11:</td><td style="text-align: right;">*10.7</td><td style="text-align: right;">↘</td></tr> <tr><td style="text-align: right;">12:</td><td style="text-align: right;">9.9</td><td style="text-align: right;">←</td></tr> <tr><td style="text-align: right;">13:</td><td style="text-align: right;">*10.9</td><td style="text-align: right;">↘</td></tr> <tr><td style="text-align: right;">14:</td><td style="text-align: right;">*10.5</td><td style="text-align: right;">↗</td></tr> <tr><td style="text-align: right;">15:</td><td style="text-align: right;">10.1</td><td style="text-align: right;">↑</td></tr> <tr><td style="text-align: right;">16:</td><td style="text-align: right;">9.9</td><td style="text-align: right;">↗</td></tr> <tr><td style="text-align: right;">17:</td><td style="text-align: right;">10.3</td><td style="text-align: right;">↘</td></tr> <tr><td style="text-align: right;">18:</td><td style="text-align: right;">10.2</td><td style="text-align: right;">↘</td></tr> <tr><td style="text-align: right;">19:</td><td style="text-align: right;">10.0</td><td style="text-align: right;">↘</td></tr> <tr><td style="text-align: right;">20:</td><td style="text-align: right;">*10.7</td><td style="text-align: right;">↑</td></tr> </table> <table border="1" style="width:100%; border-collapse: collapse; margin-top: 5px;"> <tr> <td style="width:80%;">Serie</td> <td style="text-align: right;">98.0</td> </tr> <tr> <td>Total</td> <td style="text-align: right;">195.0</td> </tr> </table> | 11: | *10.7 | ↘ | 12: | 9.9 | ← | 13: | *10.9 | ↘ | 14: | *10.5 | ↗ | 15: | 10.1 | ↑ | 16: | 9.9 | ↗ | 17: | 10.3 | ↘ | 18: | 10.2 | ↘ | 19: | 10.0 | ↘ | 20: | *10.7 | ↑ | Serie | 98.0 | Total | 195.0 |
| 11: | *10.7 | ↘ | | | | | | | | | | | | | | | | | | | | | | | | | | | | | | | | | |
| 12: | 9.9 | ← | | | | | | | | | | | | | | | | | | | | | | | | | | | | | | | | | |
| 13: | *10.9 | ↘ | | | | | | | | | | | | | | | | | | | | | | | | | | | | | | | | | |
| 14: | *10.5 | ↗ | | | | | | | | | | | | | | | | | | | | | | | | | | | | | | | | | |
| 15: | 10.1 | ↑ | | | | | | | | | | | | | | | | | | | | | | | | | | | | | | | | | |
| 16: | 9.9 | ↗ | | | | | | | | | | | | | | | | | | | | | | | | | | | | | | | | | |
| 17: | 10.3 | ↘ | | | | | | | | | | | | | | | | | | | | | | | | | | | | | | | | | |
| 18: | 10.2 | ↘ | | | | | | | | | | | | | | | | | | | | | | | | | | | | | | | | | |
| 19: | 10.0 | ↘ | | | | | | | | | | | | | | | | | | | | | | | | | | | | | | | | | |
| 20: | *10.7 | ↑ | | | | | | | | | | | | | | | | | | | | | | | | | | | | | | | | | |
| Serie | 98.0 | | | | | | | | | | | | | | | | | | | | | | | | | | | | | | | | | | |
| Total | 195.0 | | | | | | | | | | | | | | | | | | | | | | | | | | | | | | | | | | |

| | | | | | | | | | | | | | | | | | | | | |
|---------------------|---|----|------|---|----|-----|---|----|-------|---|----|------|---|----|------|---|-------|------|-------|-----|
| <p>Prøve</p> | <table style="width:100%; border-collapse: collapse;"> <tr><td style="text-align: right;">1:</td><td style="text-align: right;">10.3</td><td style="text-align: right;">↗</td></tr> <tr><td style="text-align: right;">2:</td><td style="text-align: right;">9.6</td><td style="text-align: right;">↙</td></tr> <tr><td style="text-align: right;">3:</td><td style="text-align: right;">*10.7</td><td style="text-align: right;">↑</td></tr> <tr><td style="text-align: right;">4:</td><td style="text-align: right;">10.1</td><td style="text-align: right;">↓</td></tr> <tr><td style="text-align: right;">5:</td><td style="text-align: right;">10.4</td><td style="text-align: right;">↗</td></tr> </table> <table border="1" style="width:100%; border-collapse: collapse; margin-top: 10px;"> <tr> <td style="width:80%;">Serie</td> <td style="text-align: right;">49.0</td> </tr> <tr> <td>Total</td> <td style="text-align: right;">0.0</td> </tr> </table> | 1: | 10.3 | ↗ | 2: | 9.6 | ↙ | 3: | *10.7 | ↑ | 4: | 10.1 | ↓ | 5: | 10.4 | ↗ | Serie | 49.0 | Total | 0.0 |
| 1: | 10.3 | ↗ | | | | | | | | | | | | | | | | | | |
| 2: | 9.6 | ↙ | | | | | | | | | | | | | | | | | | |
| 3: | *10.7 | ↑ | | | | | | | | | | | | | | | | | | |
| 4: | 10.1 | ↓ | | | | | | | | | | | | | | | | | | |
| 5: | 10.4 | ↗ | | | | | | | | | | | | | | | | | | |
| Serie | 49.0 | | | | | | | | | | | | | | | | | | | |
| Total | 0.0 | | | | | | | | | | | | | | | | | | | |

| | | | | | | | | | | | | | | | | | | | | | | | | | | | | | | | | | | | |
|-----------------------|---|----|-------|---|----|-------|---|----|-----|---|----|-------|---|----|-----|---|----|-----|---|----|------|---|----|-------|---|----|------|---|-----|------|---|-------|------|-------|------|
| <p>20 Skud</p> | <table style="width:100%; border-collapse: collapse;"> <tr><td style="text-align: right;">1:</td><td style="text-align: right;">*10.9</td><td style="text-align: right;">↗</td></tr> <tr><td style="text-align: right;">2:</td><td style="text-align: right;">*10.7</td><td style="text-align: right;">↖</td></tr> <tr><td style="text-align: right;">3:</td><td style="text-align: right;">9.9</td><td style="text-align: right;">↑</td></tr> <tr><td style="text-align: right;">4:</td><td style="text-align: right;">*10.9</td><td style="text-align: right;">→</td></tr> <tr><td style="text-align: right;">5:</td><td style="text-align: right;">9.9</td><td style="text-align: right;">↖</td></tr> <tr><td style="text-align: right;">6:</td><td style="text-align: right;">9.9</td><td style="text-align: right;">↘</td></tr> <tr><td style="text-align: right;">7:</td><td style="text-align: right;">10.1</td><td style="text-align: right;">↗</td></tr> <tr><td style="text-align: right;">8:</td><td style="text-align: right;">*10.8</td><td style="text-align: right;">↓</td></tr> <tr><td style="text-align: right;">9:</td><td style="text-align: right;">10.5</td><td style="text-align: right;">↘</td></tr> <tr><td style="text-align: right;">10:</td><td style="text-align: right;">10.3</td><td style="text-align: right;">↗</td></tr> </table> <table border="1" style="width:100%; border-collapse: collapse; margin-top: 10px;"> <tr> <td style="width:80%;">Serie</td> <td style="text-align: right;">97.0</td> </tr> <tr> <td>Total</td> <td style="text-align: right;">97.0</td> </tr> </table> | 1: | *10.9 | ↗ | 2: | *10.7 | ↖ | 3: | 9.9 | ↑ | 4: | *10.9 | → | 5: | 9.9 | ↖ | 6: | 9.9 | ↘ | 7: | 10.1 | ↗ | 8: | *10.8 | ↓ | 9: | 10.5 | ↘ | 10: | 10.3 | ↗ | Serie | 97.0 | Total | 97.0 |
| 1: | *10.9 | ↗ | | | | | | | | | | | | | | | | | | | | | | | | | | | | | | | | | |
| 2: | *10.7 | ↖ | | | | | | | | | | | | | | | | | | | | | | | | | | | | | | | | | |
| 3: | 9.9 | ↑ | | | | | | | | | | | | | | | | | | | | | | | | | | | | | | | | | |
| 4: | *10.9 | → | | | | | | | | | | | | | | | | | | | | | | | | | | | | | | | | | |
| 5: | 9.9 | ↖ | | | | | | | | | | | | | | | | | | | | | | | | | | | | | | | | | |
| 6: | 9.9 | ↘ | | | | | | | | | | | | | | | | | | | | | | | | | | | | | | | | | |
| 7: | 10.1 | ↗ | | | | | | | | | | | | | | | | | | | | | | | | | | | | | | | | | |
| 8: | *10.8 | ↓ | | | | | | | | | | | | | | | | | | | | | | | | | | | | | | | | | |
| 9: | 10.5 | ↘ | | | | | | | | | | | | | | | | | | | | | | | | | | | | | | | | | |
| 10: | 10.3 | ↗ | | | | | | | | | | | | | | | | | | | | | | | | | | | | | | | | | |
| Serie | 97.0 | | | | | | | | | | | | | | | | | | | | | | | | | | | | | | | | | | |
| Total | 97.0 | | | | | | | | | | | | | | | | | | | | | | | | | | | | | | | | | | |

| | | | | | | | | | | | | | | | | | | | | | | | | | | | | | | | | | | | |
|-----------------------|---|-----|-----|---|-----|------|---|-----|------|---|-----|------|---|-----|------|---|-----|-------|---|-----|------|---|-----|------|---|-----|------|---|-----|-----|---|-------|------|-------|-------|
| <p>20 Skud</p> | <table style="width:100%; border-collapse: collapse;"> <tr><td style="text-align: right;">11:</td><td style="text-align: right;">9.9</td><td style="text-align: right;">↖</td></tr> <tr><td style="text-align: right;">12:</td><td style="text-align: right;">10.4</td><td style="text-align: right;">↑</td></tr> <tr><td style="text-align: right;">13:</td><td style="text-align: right;">10.5</td><td style="text-align: right;">↖</td></tr> <tr><td style="text-align: right;">14:</td><td style="text-align: right;">10.4</td><td style="text-align: right;">↖</td></tr> <tr><td style="text-align: right;">15:</td><td style="text-align: right;">10.1</td><td style="text-align: right;">→</td></tr> <tr><td style="text-align: right;">16:</td><td style="text-align: right;">*10.6</td><td style="text-align: right;">↑</td></tr> <tr><td style="text-align: right;">17:</td><td style="text-align: right;">10.1</td><td style="text-align: right;">↗</td></tr> <tr><td style="text-align: right;">18:</td><td style="text-align: right;">10.4</td><td style="text-align: right;">↗</td></tr> <tr><td style="text-align: right;">19:</td><td style="text-align: right;">10.2</td><td style="text-align: right;">↗</td></tr> <tr><td style="text-align: right;">20:</td><td style="text-align: right;">9.9</td><td style="text-align: right;">↓</td></tr> </table> <table border="1" style="width:100%; border-collapse: collapse; margin-top: 10px;"> <tr> <td style="width:80%;">Serie</td> <td style="text-align: right;">98.0</td> </tr> <tr> <td>Total</td> <td style="text-align: right;">195.0</td> </tr> </table> | 11: | 9.9 | ↖ | 12: | 10.4 | ↑ | 13: | 10.5 | ↖ | 14: | 10.4 | ↖ | 15: | 10.1 | → | 16: | *10.6 | ↑ | 17: | 10.1 | ↗ | 18: | 10.4 | ↗ | 19: | 10.2 | ↗ | 20: | 9.9 | ↓ | Serie | 98.0 | Total | 195.0 |
| 11: | 9.9 | ↖ | | | | | | | | | | | | | | | | | | | | | | | | | | | | | | | | | |
| 12: | 10.4 | ↑ | | | | | | | | | | | | | | | | | | | | | | | | | | | | | | | | | |
| 13: | 10.5 | ↖ | | | | | | | | | | | | | | | | | | | | | | | | | | | | | | | | | |
| 14: | 10.4 | ↖ | | | | | | | | | | | | | | | | | | | | | | | | | | | | | | | | | |
| 15: | 10.1 | → | | | | | | | | | | | | | | | | | | | | | | | | | | | | | | | | | |
| 16: | *10.6 | ↑ | | | | | | | | | | | | | | | | | | | | | | | | | | | | | | | | | |
| 17: | 10.1 | ↗ | | | | | | | | | | | | | | | | | | | | | | | | | | | | | | | | | |
| 18: | 10.4 | ↗ | | | | | | | | | | | | | | | | | | | | | | | | | | | | | | | | | |
| 19: | 10.2 | ↗ | | | | | | | | | | | | | | | | | | | | | | | | | | | | | | | | | |
| 20: | 9.9 | ↓ | | | | | | | | | | | | | | | | | | | | | | | | | | | | | | | | | |
| Serie | 98.0 | | | | | | | | | | | | | | | | | | | | | | | | | | | | | | | | | | |
| Total | 195.0 | | | | | | | | | | | | | | | | | | | | | | | | | | | | | | | | | | |

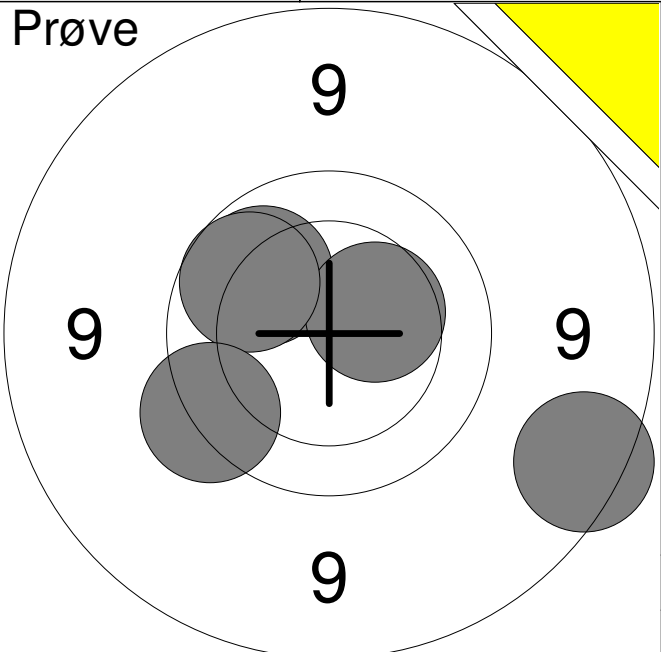
| | | | | | | | | | | | | | | | | | | | | |
|--|---|----|------|---|----|-----|---|----|------|---|----|-----|---|----|-----|---|-------|------|-------|-----|
| <p>Prøve</p>  | <table style="width:100%; border-collapse: collapse;"> <tr><td style="text-align: right;">1:</td><td style="text-align: right;">10.0</td><td style="text-align: right;">↗</td></tr> <tr><td style="text-align: right;">2:</td><td style="text-align: right;">8.8</td><td style="text-align: right;">↘</td></tr> <tr><td style="text-align: right;">3:</td><td style="text-align: right;">10.4</td><td style="text-align: right;">→</td></tr> <tr><td style="text-align: right;">4:</td><td style="text-align: right;">9.9</td><td style="text-align: right;">↗</td></tr> <tr><td style="text-align: right;">5:</td><td style="text-align: right;">9.6</td><td style="text-align: right;">↙</td></tr> </table> <table border="1" style="width:100%; border-collapse: collapse; margin-top: 5px;"> <tr> <td style="width:80%;">Serie</td> <td style="text-align: right;">46.0</td> </tr> <tr> <td>Total</td> <td style="text-align: right;">0.0</td> </tr> </table> | 1: | 10.0 | ↗ | 2: | 8.8 | ↘ | 3: | 10.4 | → | 4: | 9.9 | ↗ | 5: | 9.6 | ↙ | Serie | 46.0 | Total | 0.0 |
| 1: | 10.0 | ↗ | | | | | | | | | | | | | | | | | | |
| 2: | 8.8 | ↘ | | | | | | | | | | | | | | | | | | |
| 3: | 10.4 | → | | | | | | | | | | | | | | | | | | |
| 4: | 9.9 | ↗ | | | | | | | | | | | | | | | | | | |
| 5: | 9.6 | ↙ | | | | | | | | | | | | | | | | | | |
| Serie | 46.0 | | | | | | | | | | | | | | | | | | | |
| Total | 0.0 | | | | | | | | | | | | | | | | | | | |

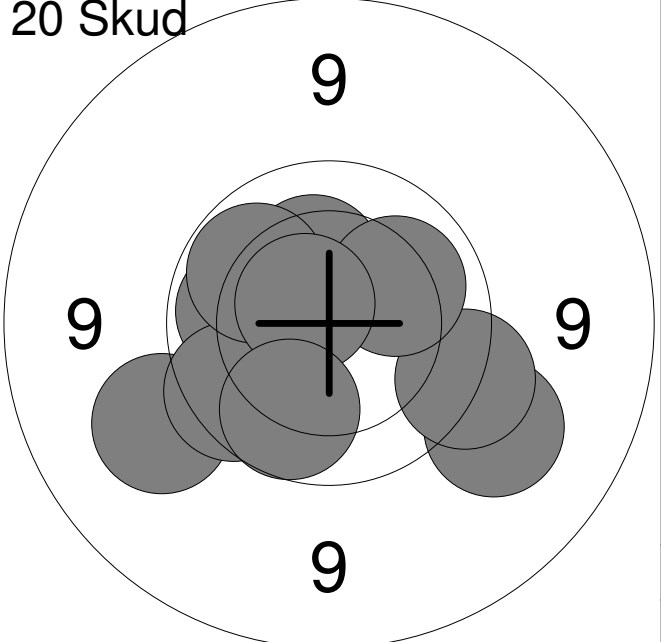
| | | | | | | | | | | | | | | | | | | | | | | | | | | | | | | | | | | | |
|---|---|----|------|---|----|-----|---|----|-----|---|----|-----|---|----|-----|---|----|------|---|----|------|---|----|------|---|----|-------|---|-----|-----|---|-------|------|-------|------|
| <p>20 Skud</p>  | <table style="width:100%; border-collapse: collapse;"> <tr><td style="text-align: right;">1:</td><td style="text-align: right;">10.0</td><td style="text-align: right;">←</td></tr> <tr><td style="text-align: right;">2:</td><td style="text-align: right;">9.3</td><td style="text-align: right;">↙</td></tr> <tr><td style="text-align: right;">3:</td><td style="text-align: right;">9.3</td><td style="text-align: right;">↘</td></tr> <tr><td style="text-align: right;">4:</td><td style="text-align: right;">9.6</td><td style="text-align: right;">↘</td></tr> <tr><td style="text-align: right;">5:</td><td style="text-align: right;">9.8</td><td style="text-align: right;">↙</td></tr> <tr><td style="text-align: right;">6:</td><td style="text-align: right;">10.3</td><td style="text-align: right;">↗</td></tr> <tr><td style="text-align: right;">7:</td><td style="text-align: right;">10.1</td><td style="text-align: right;">↗</td></tr> <tr><td style="text-align: right;">8:</td><td style="text-align: right;">10.0</td><td style="text-align: right;">↗</td></tr> <tr><td style="text-align: right;">9:</td><td style="text-align: right;">*10.6</td><td style="text-align: right;">↗</td></tr> <tr><td style="text-align: right;">10:</td><td style="text-align: right;">9.9</td><td style="text-align: right;">↙</td></tr> </table> <table border="1" style="width:100%; border-collapse: collapse; margin-top: 5px;"> <tr> <td style="width:80%;">Serie</td> <td style="text-align: right;">95.0</td> </tr> <tr> <td>Total</td> <td style="text-align: right;">95.0</td> </tr> </table> | 1: | 10.0 | ← | 2: | 9.3 | ↙ | 3: | 9.3 | ↘ | 4: | 9.6 | ↘ | 5: | 9.8 | ↙ | 6: | 10.3 | ↗ | 7: | 10.1 | ↗ | 8: | 10.0 | ↗ | 9: | *10.6 | ↗ | 10: | 9.9 | ↙ | Serie | 95.0 | Total | 95.0 |
| 1: | 10.0 | ← | | | | | | | | | | | | | | | | | | | | | | | | | | | | | | | | | |
| 2: | 9.3 | ↙ | | | | | | | | | | | | | | | | | | | | | | | | | | | | | | | | | |
| 3: | 9.3 | ↘ | | | | | | | | | | | | | | | | | | | | | | | | | | | | | | | | | |
| 4: | 9.6 | ↘ | | | | | | | | | | | | | | | | | | | | | | | | | | | | | | | | | |
| 5: | 9.8 | ↙ | | | | | | | | | | | | | | | | | | | | | | | | | | | | | | | | | |
| 6: | 10.3 | ↗ | | | | | | | | | | | | | | | | | | | | | | | | | | | | | | | | | |
| 7: | 10.1 | ↗ | | | | | | | | | | | | | | | | | | | | | | | | | | | | | | | | | |
| 8: | 10.0 | ↗ | | | | | | | | | | | | | | | | | | | | | | | | | | | | | | | | | |
| 9: | *10.6 | ↗ | | | | | | | | | | | | | | | | | | | | | | | | | | | | | | | | | |
| 10: | 9.9 | ↙ | | | | | | | | | | | | | | | | | | | | | | | | | | | | | | | | | |
| Serie | 95.0 | | | | | | | | | | | | | | | | | | | | | | | | | | | | | | | | | | |
| Total | 95.0 | | | | | | | | | | | | | | | | | | | | | | | | | | | | | | | | | | |

| | | | | | | | | | | | | | | | | | | | | | | | | | | | | | | | | | | | |
|--|---|-----|-----|---|-----|------|---|-----|-----|---|-----|-----|---|-----|-----|---|-----|------|---|-----|-----|---|-----|------|---|-----|------|---|-----|-----|---|-------|------|-------|-------|
| <p>20 Skud</p>  | <table style="width:100%; border-collapse: collapse;"> <tr><td style="text-align: right;">11:</td><td style="text-align: right;">9.7</td><td style="text-align: right;">↘</td></tr> <tr><td style="text-align: right;">12:</td><td style="text-align: right;">10.0</td><td style="text-align: right;">↗</td></tr> <tr><td style="text-align: right;">13:</td><td style="text-align: right;">9.9</td><td style="text-align: right;">→</td></tr> <tr><td style="text-align: right;">14:</td><td style="text-align: right;">8.8</td><td style="text-align: right;">↘</td></tr> <tr><td style="text-align: right;">15:</td><td style="text-align: right;">9.8</td><td style="text-align: right;">↙</td></tr> <tr><td style="text-align: right;">16:</td><td style="text-align: right;">10.0</td><td style="text-align: right;">↙</td></tr> <tr><td style="text-align: right;">17:</td><td style="text-align: right;">9.3</td><td style="text-align: right;">↗</td></tr> <tr><td style="text-align: right;">18:</td><td style="text-align: right;">10.0</td><td style="text-align: right;">↘</td></tr> <tr><td style="text-align: right;">19:</td><td style="text-align: right;">10.1</td><td style="text-align: right;">↗</td></tr> <tr><td style="text-align: right;">20:</td><td style="text-align: right;">9.2</td><td style="text-align: right;">↘</td></tr> </table> <table border="1" style="width:100%; border-collapse: collapse; margin-top: 5px;"> <tr> <td style="width:80%;">Serie</td> <td style="text-align: right;">93.0</td> </tr> <tr> <td>Total</td> <td style="text-align: right;">188.0</td> </tr> </table> | 11: | 9.7 | ↘ | 12: | 10.0 | ↗ | 13: | 9.9 | → | 14: | 8.8 | ↘ | 15: | 9.8 | ↙ | 16: | 10.0 | ↙ | 17: | 9.3 | ↗ | 18: | 10.0 | ↘ | 19: | 10.1 | ↗ | 20: | 9.2 | ↘ | Serie | 93.0 | Total | 188.0 |
| 11: | 9.7 | ↘ | | | | | | | | | | | | | | | | | | | | | | | | | | | | | | | | | |
| 12: | 10.0 | ↗ | | | | | | | | | | | | | | | | | | | | | | | | | | | | | | | | | |
| 13: | 9.9 | → | | | | | | | | | | | | | | | | | | | | | | | | | | | | | | | | | |
| 14: | 8.8 | ↘ | | | | | | | | | | | | | | | | | | | | | | | | | | | | | | | | | |
| 15: | 9.8 | ↙ | | | | | | | | | | | | | | | | | | | | | | | | | | | | | | | | | |
| 16: | 10.0 | ↙ | | | | | | | | | | | | | | | | | | | | | | | | | | | | | | | | | |
| 17: | 9.3 | ↗ | | | | | | | | | | | | | | | | | | | | | | | | | | | | | | | | | |
| 18: | 10.0 | ↘ | | | | | | | | | | | | | | | | | | | | | | | | | | | | | | | | | |
| 19: | 10.1 | ↗ | | | | | | | | | | | | | | | | | | | | | | | | | | | | | | | | | |
| 20: | 9.2 | ↘ | | | | | | | | | | | | | | | | | | | | | | | | | | | | | | | | | |
| Serie | 93.0 | | | | | | | | | | | | | | | | | | | | | | | | | | | | | | | | | | |
| Total | 188.0 | | | | | | | | | | | | | | | | | | | | | | | | | | | | | | | | | | |

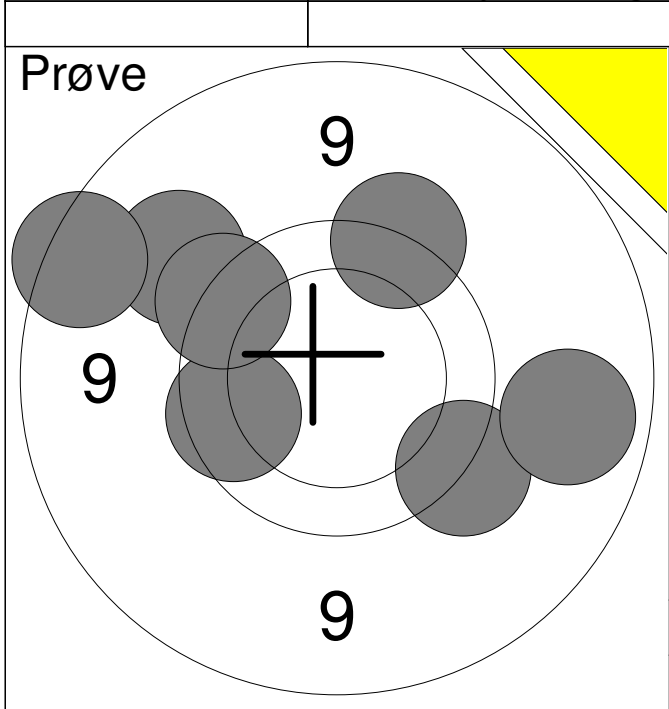

| | | |
|-------|-----|------|
| 1: | 9.3 | ↗ |
| 2: | 9.5 | ↘ |
| 3: | 9.6 | ↗ |
| 4: | 8.8 | ↗ |
| 5: | 9.8 | ↖ |
| 6: | 9.6 | ↗ |
| 7: | 9.0 | ↘ |
| Serie | | 62.0 |
| Total | | 0.0 |

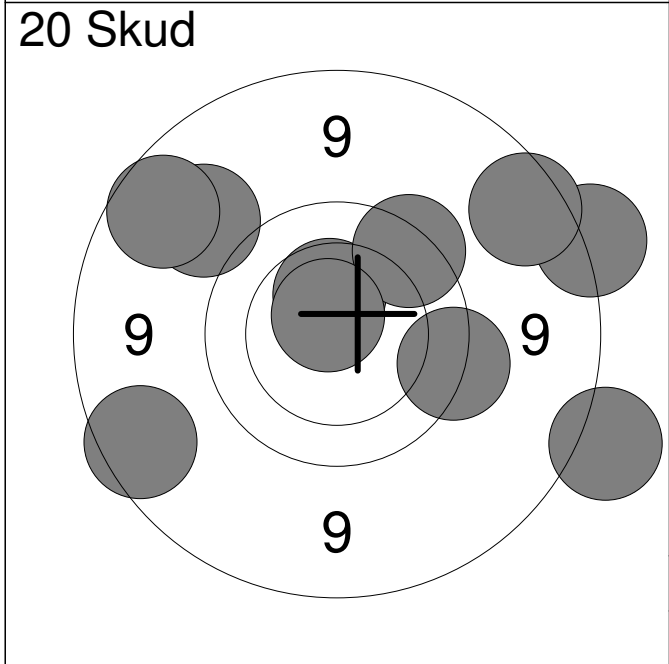

| | | |
|-------|-------|------|
| 1: | 8.6 | → |
| 2: | 8.5 | ↘ |
| 3: | 9.2 | ↗ |
| 4: | 10.4 | ↗ |
| 5: | 9.7 | ↗ |
| 6: | 8.9 | ↗ |
| 7: | 8.9 | ↗ |
| 8: | 8.9 | ↖ |
| 9: | 9.6 | → |
| 10: | *10.7 | ↗ |
| Serie | | 87.0 |
| Total | | 87.0 |

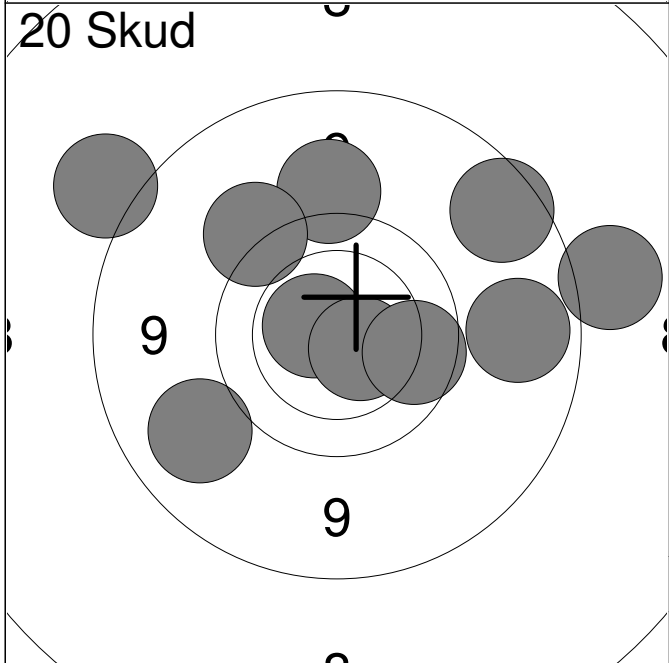

| | | |
|-------|-------|-------|
| 11: | 9.1 | ↖ |
| 12: | *10.6 | ↖ |
| 13: | 9.3 | ↗ |
| 14: | 8.5 | → |
| 15: | *10.6 | ↘ |
| 16: | 9.5 | ↗ |
| 17: | 8.5 | ↗ |
| 18: | 8.9 | ↗ |
| 19: | 9.9 | → |
| 20: | 9.0 | → |
| Serie | | 89.0 |
| Total | | 176.0 |



| | | | | | | |
|------------|-----------|-------|------|-------------|-------|------|
| 1: 10.3 ↗ | 6: 10.4 ↓ | Serie | 95.0 | 11: 9.8 → | Serie | 29.0 |
| 2: *10.5 ↗ | 7: 9.8 ↓ | | | 12: *10.9 ↗ | | |
| 3: 9.8 ↖ | 8: 9.6 ↓ | Total | 0.0 | 13: 10.2 ↖ | Total | 0.0 |
| 4: 9.9 ← | 9: 10.1 → | | | 10: 10.2 ↓ | | |
| 5: 9.8 → | | | | | | |

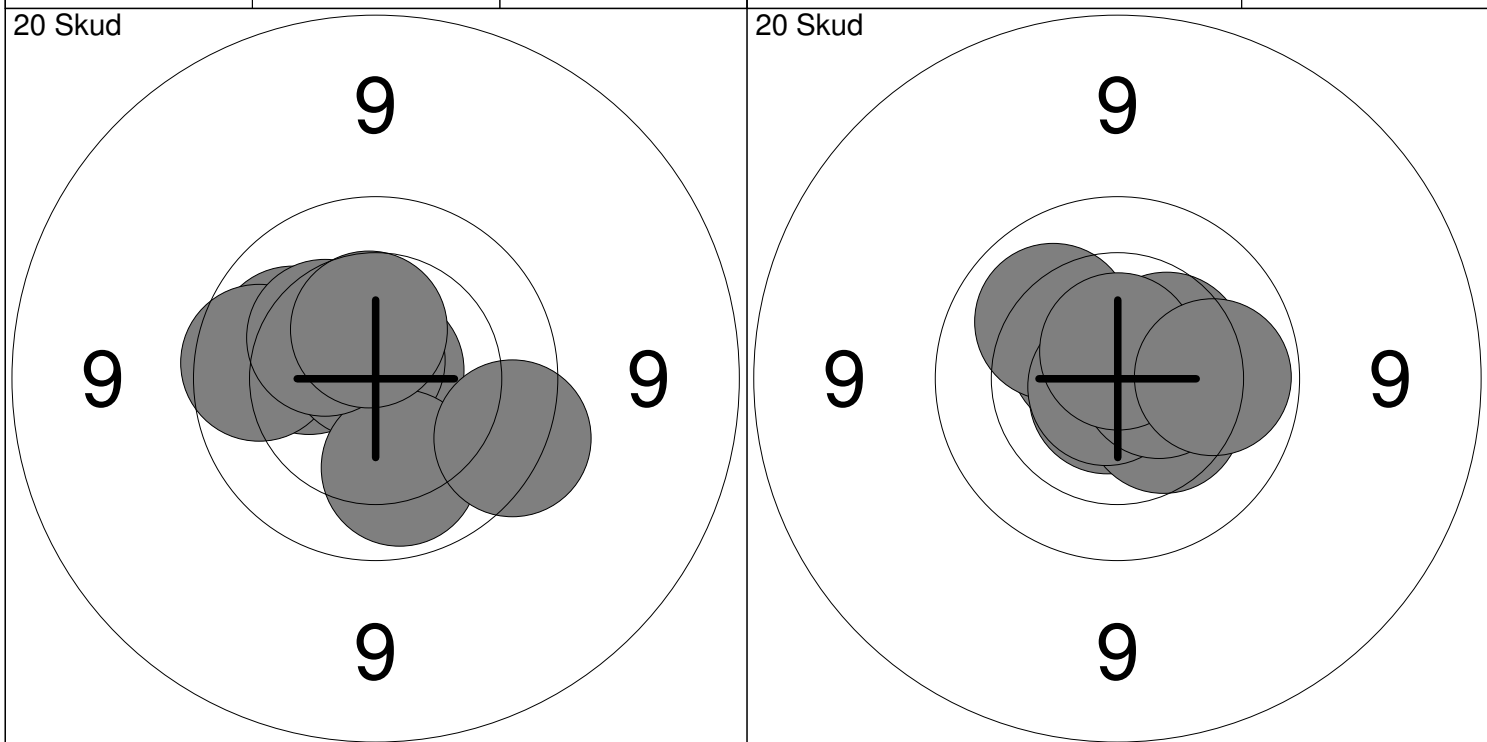

| | | | | | | | |
|------------|------------|-------|------|-------------|-------------|-------|-------|
| 1: *10.7 ↗ | 6: *10.8 ↗ | Serie | 98.0 | 11: *10.7 ↗ | 16: 10.1 ↖ | Serie | 100.0 |
| 2: 10.1 ↖ | 7: 10.1 ↓ | | | 12: *10.8 ↓ | 17: *10.8 ↖ | | |
| 3: 10.3 ↖ | 8: 10.3 ↗ | Total | 98.0 | 13: 10.4 ↓ | 18: *10.5 → | Total | 198.0 |
| 4: *10.8 ↗ | 9: 10.5 ↗ | | | 14: *10.6 ↖ | 19: *10.7 ↗ | | |
| 5: 9.9 ← | 10: 9.7 ↓ | | | 15: 10.4 ↗ | 20: 10.0 → | | |

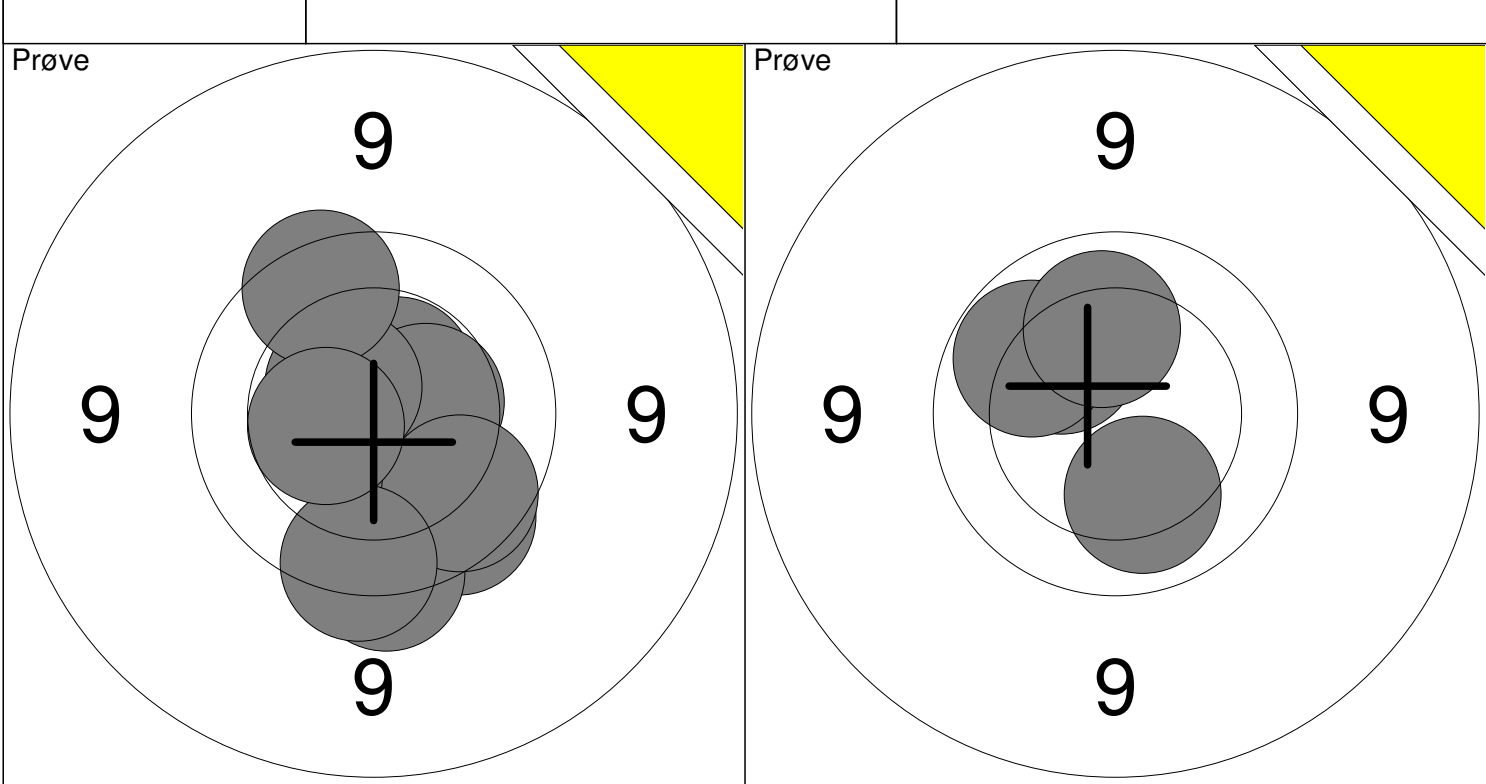

| | | | | | | |
|------------|------------|-------|------|------------|-------|------|
| 1: 9.8 ↘ | 6: 9.9 ↘ | Serie | 95.0 | 11: 10.2 ↗ | Serie | 40.0 |
| 2: *10.5 ↗ | 7: 9.7 ↘ | | | 12: 10.0 ↗ | | |
| 3: 9.6 ↘ | 8: *10.6 ↗ | Total | 0.0 | 13: 10.1 ↘ | Total | 0.0 |
| 4: 10.4 ↘ | 9: 9.8 ↗ | | | 14: 10.1 ↗ | | |
| 5: 10.4 → | 10: 10.5 ← | | | | | |

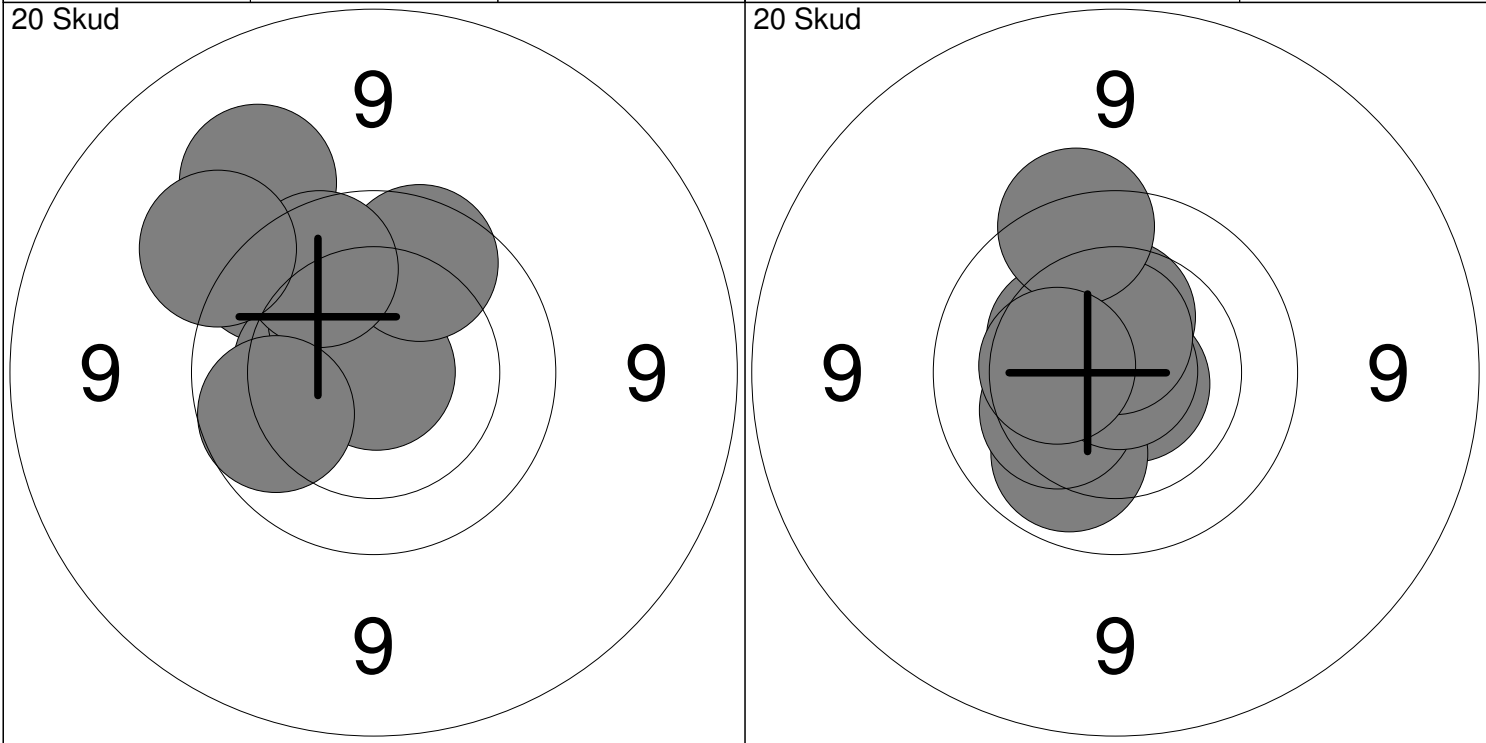

| | | | | | | | |
|------------|-----------|-------|------|-------------|-------------|------------|------------|
| 1: 9.7 ↗ | 6: 9.9 ↗ | Serie | 94.0 | 11: *10.8 ↘ | 16: 10.4 ↖ | Serie | 99.0 |
| 2: 10.4 ← | 7: 9.3 ↗ | | | 12: 10.4 ← | 17: *10.9 → | | |
| 3: 10.4 ↗ | 8: 9.9 ↗ | Total | 94.0 | 13: 10.4 ↑ | 18: *10.6 ↑ | Total | 193.0 |
| 4: 10.1 ↗ | 9: 9.9 ← | | | 14: 10.1 ↘ | 19: 9.7 ↑ | | |
| 5: *10.9 → | 10: 9.4 ↗ | | | | | 15: 10.3 ↖ | 20: 10.4 ← |

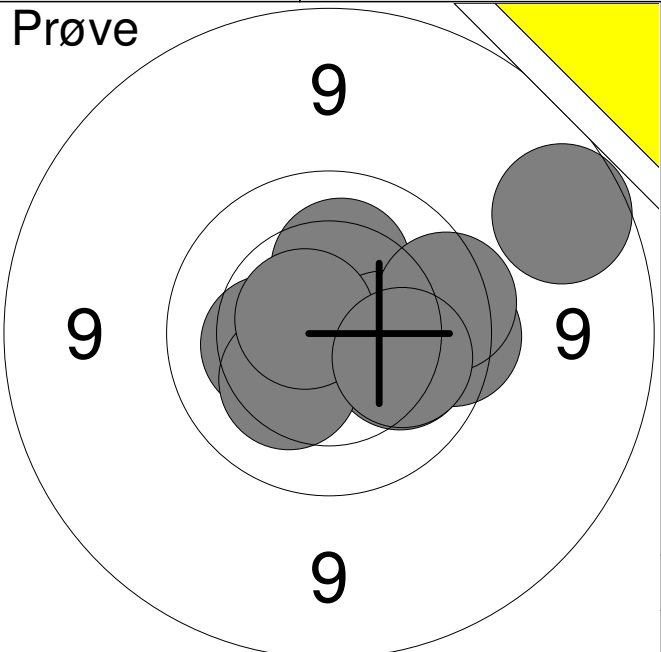
| | | | | | | | | | | | | | | | | | | | | | | | | | | | | | | | | | | | | | |
|--|---|------|-----|---|----|------|---|----|------|---|----|-----|---|----|------|---|----|------|---|----|-----|---|----|------|---|----|-------|---|-----|------|---|-------|--|------|-------|--|-----|
| <p>Prøve</p>  | <table style="width:100%; border-collapse: collapse;"> <tr><td style="text-align: right;">1:</td><td style="text-align: right;">8.9</td><td style="text-align: right;">➔</td></tr> <tr><td style="text-align: right;">2:</td><td style="text-align: right;">10.2</td><td style="text-align: right;">⬆</td></tr> <tr><td style="text-align: right;">3:</td><td style="text-align: right;">10.3</td><td style="text-align: right;">⬅</td></tr> <tr><td style="text-align: right;">4:</td><td style="text-align: right;">9.8</td><td style="text-align: right;">➔</td></tr> <tr><td style="text-align: right;">5:</td><td style="text-align: right;">10.1</td><td style="text-align: right;">➤</td></tr> <tr><td style="text-align: right;">6:</td><td style="text-align: right;">10.3</td><td style="text-align: right;">➔</td></tr> <tr><td style="text-align: right;">7:</td><td style="text-align: right;">9.8</td><td style="text-align: right;">➔</td></tr> <tr><td style="text-align: right;">8:</td><td style="text-align: right;">10.3</td><td style="text-align: right;">↙</td></tr> <tr><td style="text-align: right;">9:</td><td style="text-align: right;">*10.6</td><td style="text-align: right;">↗</td></tr> <tr><td style="text-align: right;">10:</td><td style="text-align: right;">10.1</td><td style="text-align: right;">➤</td></tr> <tr><td colspan="2">Serie</td><td style="text-align: right;">96.0</td></tr> <tr><td colspan="2">Total</td><td style="text-align: right;">0.0</td></tr> </table> | 1: | 8.9 | ➔ | 2: | 10.2 | ⬆ | 3: | 10.3 | ⬅ | 4: | 9.8 | ➔ | 5: | 10.1 | ➤ | 6: | 10.3 | ➔ | 7: | 9.8 | ➔ | 8: | 10.3 | ↙ | 9: | *10.6 | ↗ | 10: | 10.1 | ➤ | Serie | | 96.0 | Total | | 0.0 |
| 1: | 8.9 | ➔ | | | | | | | | | | | | | | | | | | | | | | | | | | | | | | | | | | | |
| 2: | 10.2 | ⬆ | | | | | | | | | | | | | | | | | | | | | | | | | | | | | | | | | | | |
| 3: | 10.3 | ⬅ | | | | | | | | | | | | | | | | | | | | | | | | | | | | | | | | | | | |
| 4: | 9.8 | ➔ | | | | | | | | | | | | | | | | | | | | | | | | | | | | | | | | | | | |
| 5: | 10.1 | ➤ | | | | | | | | | | | | | | | | | | | | | | | | | | | | | | | | | | | |
| 6: | 10.3 | ➔ | | | | | | | | | | | | | | | | | | | | | | | | | | | | | | | | | | | |
| 7: | 9.8 | ➔ | | | | | | | | | | | | | | | | | | | | | | | | | | | | | | | | | | | |
| 8: | 10.3 | ↙ | | | | | | | | | | | | | | | | | | | | | | | | | | | | | | | | | | | |
| 9: | *10.6 | ↗ | | | | | | | | | | | | | | | | | | | | | | | | | | | | | | | | | | | |
| 10: | 10.1 | ➤ | | | | | | | | | | | | | | | | | | | | | | | | | | | | | | | | | | | |
| Serie | | 96.0 | | | | | | | | | | | | | | | | | | | | | | | | | | | | | | | | | | | |
| Total | | 0.0 | | | | | | | | | | | | | | | | | | | | | | | | | | | | | | | | | | | |

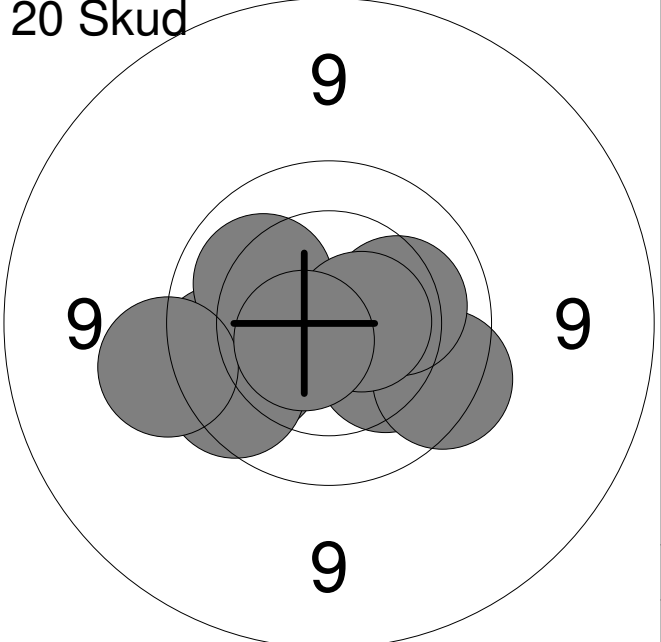
| | | | | | | | | | | | | | | | | | | | | | | | | | | | | | | | | | | | | | |
|---|--|------|------|---|----|------|---|----|-----|---|----|-----|---|----|------|---|----|-----|---|----|-----|---|----|------|---|----|-------|---|-----|-------|---|-------|--|------|-------|--|------|
| <p>20 Skud</p>  | <table style="width:100%; border-collapse: collapse;"> <tr><td style="text-align: right;">1:</td><td style="text-align: right;">10.2</td><td style="text-align: right;">➤</td></tr> <tr><td style="text-align: right;">2:</td><td style="text-align: right;">10.0</td><td style="text-align: right;">⬅</td></tr> <tr><td style="text-align: right;">3:</td><td style="text-align: right;">9.9</td><td style="text-align: right;">⬅</td></tr> <tr><td style="text-align: right;">4:</td><td style="text-align: right;">9.8</td><td style="text-align: right;">⬅</td></tr> <tr><td style="text-align: right;">5:</td><td style="text-align: right;">10.1</td><td style="text-align: right;">↗</td></tr> <tr><td style="text-align: right;">6:</td><td style="text-align: right;">9.7</td><td style="text-align: right;">➤</td></tr> <tr><td style="text-align: right;">7:</td><td style="text-align: right;">9.5</td><td style="text-align: right;">⬅</td></tr> <tr><td style="text-align: right;">8:</td><td style="text-align: right;">10.2</td><td style="text-align: right;">➔</td></tr> <tr><td style="text-align: right;">9:</td><td style="text-align: right;">*10.6</td><td style="text-align: right;">➔</td></tr> <tr><td style="text-align: right;">10:</td><td style="text-align: right;">*10.6</td><td style="text-align: right;">⬅</td></tr> <tr><td colspan="2">Serie</td><td style="text-align: right;">96.0</td></tr> <tr><td colspan="2">Total</td><td style="text-align: right;">96.0</td></tr> </table> | 1: | 10.2 | ➤ | 2: | 10.0 | ⬅ | 3: | 9.9 | ⬅ | 4: | 9.8 | ⬅ | 5: | 10.1 | ↗ | 6: | 9.7 | ➤ | 7: | 9.5 | ⬅ | 8: | 10.2 | ➔ | 9: | *10.6 | ➔ | 10: | *10.6 | ⬅ | Serie | | 96.0 | Total | | 96.0 |
| 1: | 10.2 | ➤ | | | | | | | | | | | | | | | | | | | | | | | | | | | | | | | | | | | |
| 2: | 10.0 | ⬅ | | | | | | | | | | | | | | | | | | | | | | | | | | | | | | | | | | | |
| 3: | 9.9 | ⬅ | | | | | | | | | | | | | | | | | | | | | | | | | | | | | | | | | | | |
| 4: | 9.8 | ⬅ | | | | | | | | | | | | | | | | | | | | | | | | | | | | | | | | | | | |
| 5: | 10.1 | ↗ | | | | | | | | | | | | | | | | | | | | | | | | | | | | | | | | | | | |
| 6: | 9.7 | ➤ | | | | | | | | | | | | | | | | | | | | | | | | | | | | | | | | | | | |
| 7: | 9.5 | ⬅ | | | | | | | | | | | | | | | | | | | | | | | | | | | | | | | | | | | |
| 8: | 10.2 | ➔ | | | | | | | | | | | | | | | | | | | | | | | | | | | | | | | | | | | |
| 9: | *10.6 | ➔ | | | | | | | | | | | | | | | | | | | | | | | | | | | | | | | | | | | |
| 10: | *10.6 | ⬅ | | | | | | | | | | | | | | | | | | | | | | | | | | | | | | | | | | | |
| Serie | | 96.0 | | | | | | | | | | | | | | | | | | | | | | | | | | | | | | | | | | | |
| Total | | 96.0 | | | | | | | | | | | | | | | | | | | | | | | | | | | | | | | | | | | |

| | | | | | | | | | | | | | | | | | | | | | | | | | | | | | | | | | | | | | |
|--|--|-------|-------|---|-----|------|---|-----|------|---|-----|-------|---|-----|-----|---|-----|------|---|-----|-----|---|-----|------|---|-----|-----|---|-----|-------|---|-------|--|------|-------|--|-------|
| <p>20 Skud</p>  | <table style="width:100%; border-collapse: collapse;"> <tr><td style="text-align: right;">11:</td><td style="text-align: right;">*10.6</td><td style="text-align: right;">⬆</td></tr> <tr><td style="text-align: right;">12:</td><td style="text-align: right;">10.1</td><td style="text-align: right;">⬅</td></tr> <tr><td style="text-align: right;">13:</td><td style="text-align: right;">10.4</td><td style="text-align: right;">↗</td></tr> <tr><td style="text-align: right;">14:</td><td style="text-align: right;">*10.8</td><td style="text-align: right;">➤</td></tr> <tr><td style="text-align: right;">15:</td><td style="text-align: right;">9.8</td><td style="text-align: right;">⬅</td></tr> <tr><td style="text-align: right;">16:</td><td style="text-align: right;">10.4</td><td style="text-align: right;">⬅</td></tr> <tr><td style="text-align: right;">17:</td><td style="text-align: right;">9.8</td><td style="text-align: right;">⬅</td></tr> <tr><td style="text-align: right;">18:</td><td style="text-align: right;">10.2</td><td style="text-align: right;">⬅</td></tr> <tr><td style="text-align: right;">19:</td><td style="text-align: right;">9.9</td><td style="text-align: right;">➔</td></tr> <tr><td style="text-align: right;">20:</td><td style="text-align: right;">*10.7</td><td style="text-align: right;">⬅</td></tr> <tr><td colspan="2">Serie</td><td style="text-align: right;">97.0</td></tr> <tr><td colspan="2">Total</td><td style="text-align: right;">193.0</td></tr> </table> | 11: | *10.6 | ⬆ | 12: | 10.1 | ⬅ | 13: | 10.4 | ↗ | 14: | *10.8 | ➤ | 15: | 9.8 | ⬅ | 16: | 10.4 | ⬅ | 17: | 9.8 | ⬅ | 18: | 10.2 | ⬅ | 19: | 9.9 | ➔ | 20: | *10.7 | ⬅ | Serie | | 97.0 | Total | | 193.0 |
| 11: | *10.6 | ⬆ | | | | | | | | | | | | | | | | | | | | | | | | | | | | | | | | | | | |
| 12: | 10.1 | ⬅ | | | | | | | | | | | | | | | | | | | | | | | | | | | | | | | | | | | |
| 13: | 10.4 | ↗ | | | | | | | | | | | | | | | | | | | | | | | | | | | | | | | | | | | |
| 14: | *10.8 | ➤ | | | | | | | | | | | | | | | | | | | | | | | | | | | | | | | | | | | |
| 15: | 9.8 | ⬅ | | | | | | | | | | | | | | | | | | | | | | | | | | | | | | | | | | | |
| 16: | 10.4 | ⬅ | | | | | | | | | | | | | | | | | | | | | | | | | | | | | | | | | | | |
| 17: | 9.8 | ⬅ | | | | | | | | | | | | | | | | | | | | | | | | | | | | | | | | | | | |
| 18: | 10.2 | ⬅ | | | | | | | | | | | | | | | | | | | | | | | | | | | | | | | | | | | |
| 19: | 9.9 | ➔ | | | | | | | | | | | | | | | | | | | | | | | | | | | | | | | | | | | |
| 20: | *10.7 | ⬅ | | | | | | | | | | | | | | | | | | | | | | | | | | | | | | | | | | | |
| Serie | | 97.0 | | | | | | | | | | | | | | | | | | | | | | | | | | | | | | | | | | | |
| Total | | 193.0 | | | | | | | | | | | | | | | | | | | | | | | | | | | | | | | | | | | |

Hold
3Skive
2**Per Schultz**

Vester Hassing Skf.

M3

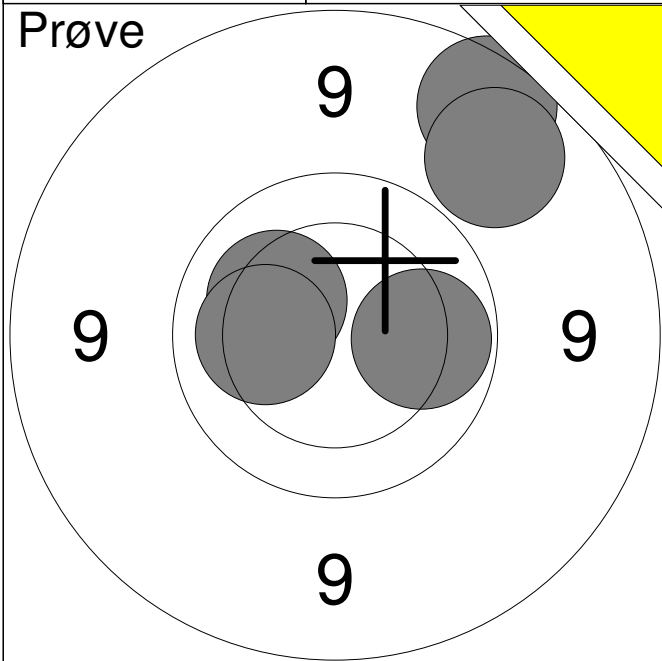
Prøve

| | | |
|----|------|---|
| 1: | 10.0 | → |
| 2: | 8.9 | ↗ |
| 3: | 9.1 | ↗ |
| 4: | 10.2 | ↗ |
| 5: | 10.2 | ← |

Serie 47.0

Total 0.0

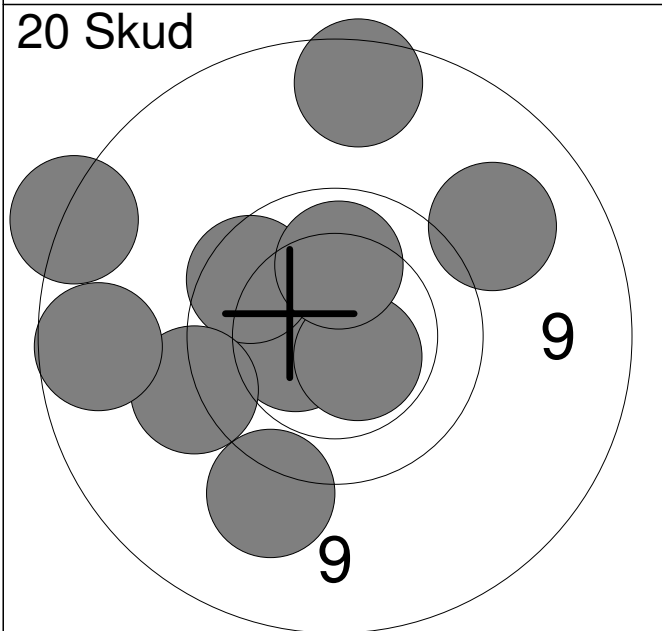
20 Skud

| | | |
|-----|-------|---|
| 1: | 10.5 | ← |
| 2: | 9.2 | ↗ |
| 3: | *10.6 | ↘ |
| 4: | 8.7 | ↗ |
| 5: | 9.8 | ↗ |
| 6: | 9.4 | ↘ |
| 7: | 9.5 | ← |
| 8: | 10.1 | ↑ |
| 9: | 8.9 | ← |
| 10: | 8.9 | ↑ |

Serie 90.0

Total 90.0

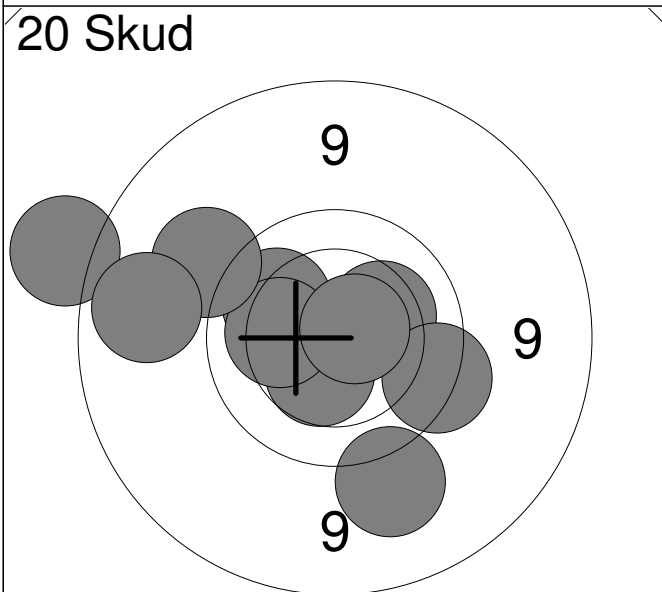
20 Skud

| | | |
|-----|-------|---|
| 11: | 8.5 | ← |
| 12: | 10.3 | ↗ |
| 13: | 10.0 | ↗ |
| 14: | 10.4 | ↘ |
| 15: | 10.2 | ← |
| 16: | 9.7 | ↘ |
| 17: | 9.3 | ↘ |
| 18: | 9.4 | ↗ |
| 19: | *10.7 | ↗ |
| 20: | 9.0 | ← |

Serie 94.0

Total 184.0

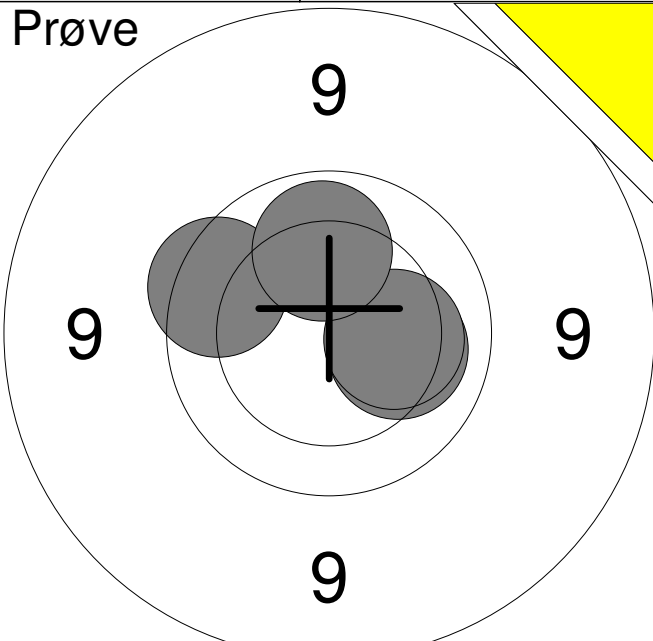
| | | | | | | | | | | | | | | | | | |
|--|---|----|-----|---|----|------|---|----|------|---|----|------|---|-------|------|-------|-----|
| <p>Prøve</p>  | <table style="width:100%; border-collapse: collapse;"> <tr><td style="width:10%;">1:</td><td style="width:15%;">9.8</td><td style="width:10%; text-align: right;">↖</td></tr> <tr><td>2:</td><td>10.2</td><td style="text-align: right;">→</td></tr> <tr><td>3:</td><td>10.2</td><td style="text-align: right;">→</td></tr> <tr><td>4:</td><td>10.1</td><td style="text-align: right;">↑</td></tr> </table> <table border="1" style="width:100%; border-collapse: collapse; margin-top: 5px;"> <tr> <td style="width:80%;">Serie</td> <td style="text-align: right;">39.0</td> </tr> <tr> <td>Total</td> <td style="text-align: right;">0.0</td> </tr> </table> | 1: | 9.8 | ↖ | 2: | 10.2 | → | 3: | 10.2 | → | 4: | 10.1 | ↑ | Serie | 39.0 | Total | 0.0 |
| 1: | 9.8 | ↖ | | | | | | | | | | | | | | | |
| 2: | 10.2 | → | | | | | | | | | | | | | | | |
| 3: | 10.2 | → | | | | | | | | | | | | | | | |
| 4: | 10.1 | ↑ | | | | | | | | | | | | | | | |
| Serie | 39.0 | | | | | | | | | | | | | | | | |
| Total | 0.0 | | | | | | | | | | | | | | | | |

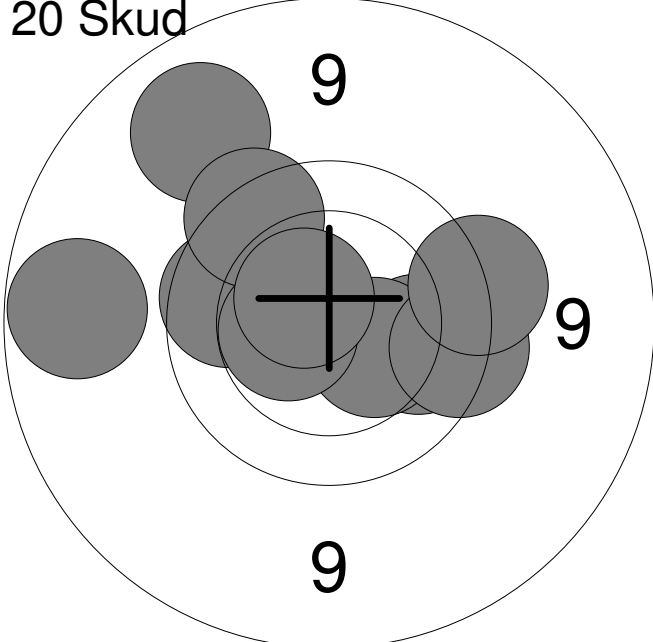
| | | | | | | | | | | | | | | | | | | | | | | | | | | | | | | | | | | | |
|---|--|----|------|---|----|-----|---|----|-----|---|----|-----|---|----|------|---|----|-----|---|----|-----|---|----|-----|---|----|-------|---|-----|-------|---|-------|------|-------|------|
| <p>20 Skud</p>  | <table style="width:100%; border-collapse: collapse;"> <tr><td style="width:10%;">1:</td><td style="width:15%;">10.0</td><td style="width:10%; text-align: right;">→</td></tr> <tr><td>2:</td><td>9.0</td><td style="text-align: right;">←</td></tr> <tr><td>3:</td><td>9.9</td><td style="text-align: right;">↖</td></tr> <tr><td>4:</td><td>9.1</td><td style="text-align: right;">↗</td></tr> <tr><td>5:</td><td>10.4</td><td style="text-align: right;">↘</td></tr> <tr><td>6:</td><td>9.7</td><td style="text-align: right;">↗</td></tr> <tr><td>7:</td><td>9.7</td><td style="text-align: right;">→</td></tr> <tr><td>8:</td><td>9.6</td><td style="text-align: right;">→</td></tr> <tr><td>9:</td><td>*10.5</td><td style="text-align: right;">←</td></tr> <tr><td>10:</td><td>*10.6</td><td style="text-align: right;">↗</td></tr> </table> <table border="1" style="width:100%; border-collapse: collapse; margin-top: 5px;"> <tr> <td style="width:80%;">Serie</td> <td style="text-align: right;">94.0</td> </tr> <tr> <td>Total</td> <td style="text-align: right;">94.0</td> </tr> </table> | 1: | 10.0 | → | 2: | 9.0 | ← | 3: | 9.9 | ↖ | 4: | 9.1 | ↗ | 5: | 10.4 | ↘ | 6: | 9.7 | ↗ | 7: | 9.7 | → | 8: | 9.6 | → | 9: | *10.5 | ← | 10: | *10.6 | ↗ | Serie | 94.0 | Total | 94.0 |
| 1: | 10.0 | → | | | | | | | | | | | | | | | | | | | | | | | | | | | | | | | | | |
| 2: | 9.0 | ← | | | | | | | | | | | | | | | | | | | | | | | | | | | | | | | | | |
| 3: | 9.9 | ↖ | | | | | | | | | | | | | | | | | | | | | | | | | | | | | | | | | |
| 4: | 9.1 | ↗ | | | | | | | | | | | | | | | | | | | | | | | | | | | | | | | | | |
| 5: | 10.4 | ↘ | | | | | | | | | | | | | | | | | | | | | | | | | | | | | | | | | |
| 6: | 9.7 | ↗ | | | | | | | | | | | | | | | | | | | | | | | | | | | | | | | | | |
| 7: | 9.7 | → | | | | | | | | | | | | | | | | | | | | | | | | | | | | | | | | | |
| 8: | 9.6 | → | | | | | | | | | | | | | | | | | | | | | | | | | | | | | | | | | |
| 9: | *10.5 | ← | | | | | | | | | | | | | | | | | | | | | | | | | | | | | | | | | |
| 10: | *10.6 | ↗ | | | | | | | | | | | | | | | | | | | | | | | | | | | | | | | | | |
| Serie | 94.0 | | | | | | | | | | | | | | | | | | | | | | | | | | | | | | | | | | |
| Total | 94.0 | | | | | | | | | | | | | | | | | | | | | | | | | | | | | | | | | | |

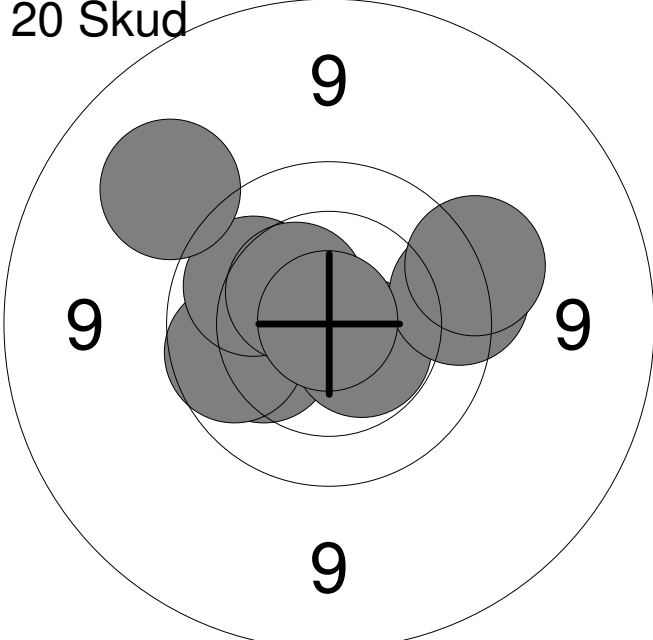
| | | | | | | | | | | | | | | | | | | | | | | | | | | | | | | | | | | | |
|--|--|-----|------|---|-----|------|---|-----|-----|---|-----|------|---|-----|-----|---|-----|-------|---|-----|------|---|-----|-----|---|-----|-----|---|-----|-------|---|-------|------|-------|-------|
| <p>20 Skud</p>  | <table style="width:100%; border-collapse: collapse;"> <tr><td style="width:10%;">11:</td><td style="width:15%;">10.2</td><td style="width:10%; text-align: right;">←</td></tr> <tr><td>12:</td><td>10.2</td><td style="text-align: right;">↖</td></tr> <tr><td>13:</td><td>9.9</td><td style="text-align: right;">←</td></tr> <tr><td>14:</td><td>10.0</td><td style="text-align: right;">↗</td></tr> <tr><td>15:</td><td>9.2</td><td style="text-align: right;">↗</td></tr> <tr><td>16:</td><td>*10.5</td><td style="text-align: right;">↘</td></tr> <tr><td>17:</td><td>10.5</td><td style="text-align: right;">↗</td></tr> <tr><td>18:</td><td>9.7</td><td style="text-align: right;">→</td></tr> <tr><td>19:</td><td>9.6</td><td style="text-align: right;">→</td></tr> <tr><td>20:</td><td>*10.9</td><td style="text-align: right;">↗</td></tr> </table> <table border="1" style="width:100%; border-collapse: collapse; margin-top: 5px;"> <tr> <td style="width:80%;">Serie</td> <td style="text-align: right;">96.0</td> </tr> <tr> <td>Total</td> <td style="text-align: right;">190.0</td> </tr> </table> | 11: | 10.2 | ← | 12: | 10.2 | ↖ | 13: | 9.9 | ← | 14: | 10.0 | ↗ | 15: | 9.2 | ↗ | 16: | *10.5 | ↘ | 17: | 10.5 | ↗ | 18: | 9.7 | → | 19: | 9.6 | → | 20: | *10.9 | ↗ | Serie | 96.0 | Total | 190.0 |
| 11: | 10.2 | ← | | | | | | | | | | | | | | | | | | | | | | | | | | | | | | | | | |
| 12: | 10.2 | ↖ | | | | | | | | | | | | | | | | | | | | | | | | | | | | | | | | | |
| 13: | 9.9 | ← | | | | | | | | | | | | | | | | | | | | | | | | | | | | | | | | | |
| 14: | 10.0 | ↗ | | | | | | | | | | | | | | | | | | | | | | | | | | | | | | | | | |
| 15: | 9.2 | ↗ | | | | | | | | | | | | | | | | | | | | | | | | | | | | | | | | | |
| 16: | *10.5 | ↘ | | | | | | | | | | | | | | | | | | | | | | | | | | | | | | | | | |
| 17: | 10.5 | ↗ | | | | | | | | | | | | | | | | | | | | | | | | | | | | | | | | | |
| 18: | 9.7 | → | | | | | | | | | | | | | | | | | | | | | | | | | | | | | | | | | |
| 19: | 9.6 | → | | | | | | | | | | | | | | | | | | | | | | | | | | | | | | | | | |
| 20: | *10.9 | ↗ | | | | | | | | | | | | | | | | | | | | | | | | | | | | | | | | | |
| Serie | 96.0 | | | | | | | | | | | | | | | | | | | | | | | | | | | | | | | | | | |
| Total | 190.0 | | | | | | | | | | | | | | | | | | | | | | | | | | | | | | | | | | |

Hold
3Skive
4**Arne Schiønning**

Aalborg Skyttekreds

V2

Prøve

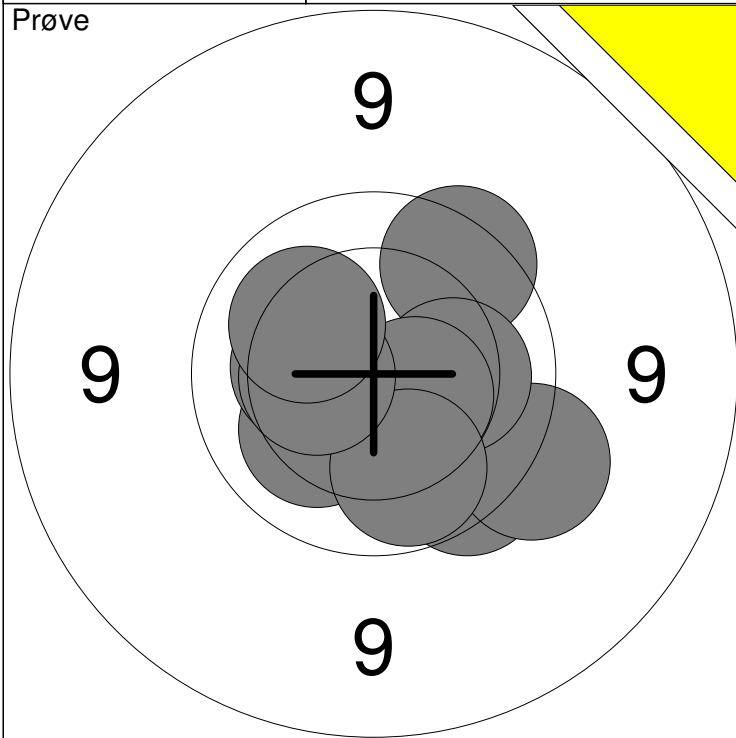

Prøve

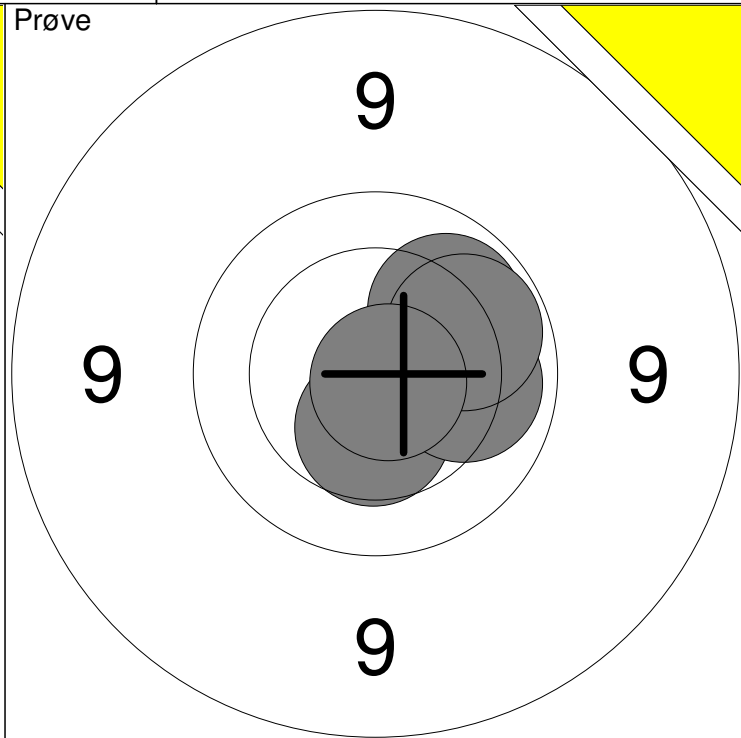

1: 9.8 ↘
2: 9.5 ↘
3: 9.8 ↗
4: 10.2 →
5: *10.5 ↘

6: 10.2 ↙
7: 10.3 ←
8: 10.0 ↘
9: 10.4 ←
10: 10.1 ↗

Serie 97.0
Total 0.0

11: 10.4 ↓
12: 10.1 →
13: 10.0 ↗
14: 10.0 ↗
15: *10.8 ↘

Serie 50.0
Total 0.0

20 Skud

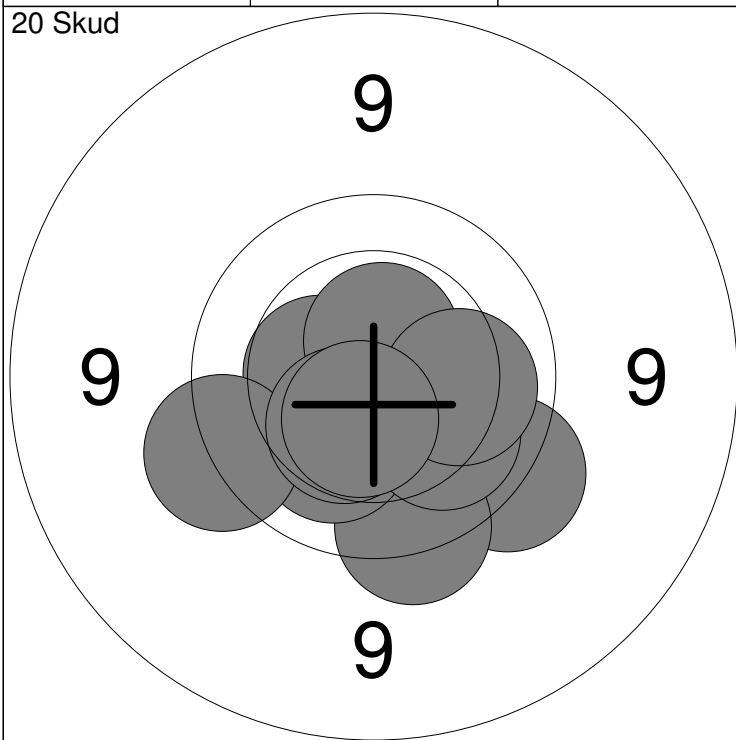

20 Skud

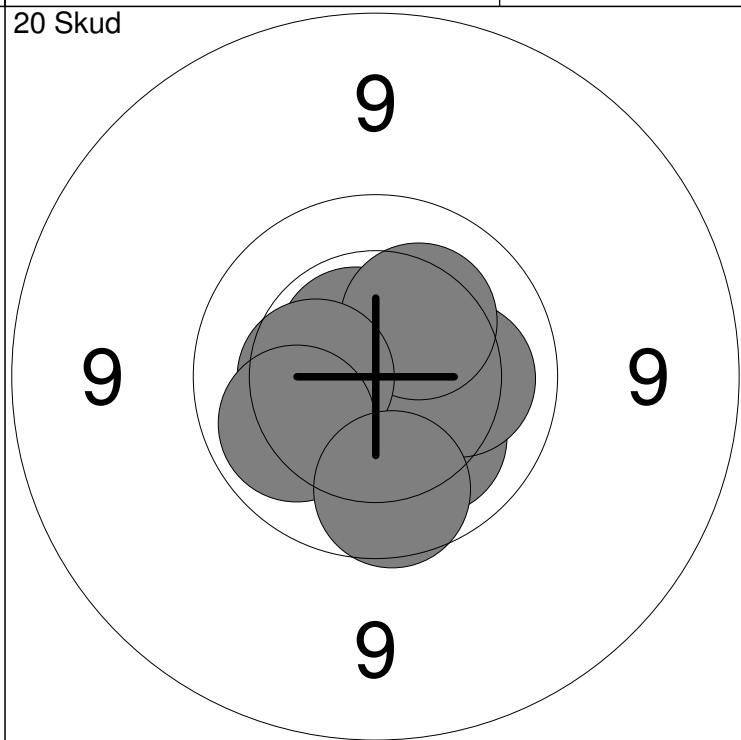

1: 9.6 ↘
2: 10.4 ←
3: *10.6 ↑
4: 9.7 ↘
5: 10.2 ↙

6: 10.1 ↘
7: 10.1 →
8: 9.6 ←
9: 10.4 ↘
10: *10.5 ↘

Serie 97.0
Total 97.0

11: 10.3 →
12: 10.4 ←
13: *10.7 ←
14: *10.6 ↗
15: 10.2 ↘

16: 10.2 →
17: 10.3 ↗
18: 10.4 ←
19: 10.1 ←
20: 9.9 ↓

Serie 99.0
Total 196.0

Hold

3

Skive

5

Lars Kjær

Hobro Egnens Skytteforening

ÅK2

Prøve

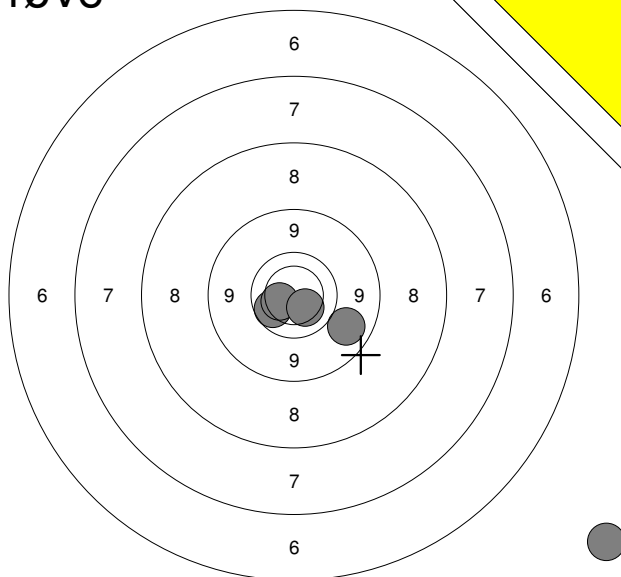

| | | |
|----|------|---|
| 1: | 0.0 | ↘ |
| 2: | 9.9 | ↙ |
| 3: | 9.1 | ↘ |
| 4: | 10.3 | ↙ |
| 5: | 10.3 | ↘ |

Serie 38.0

Total 0.0

20 Skud

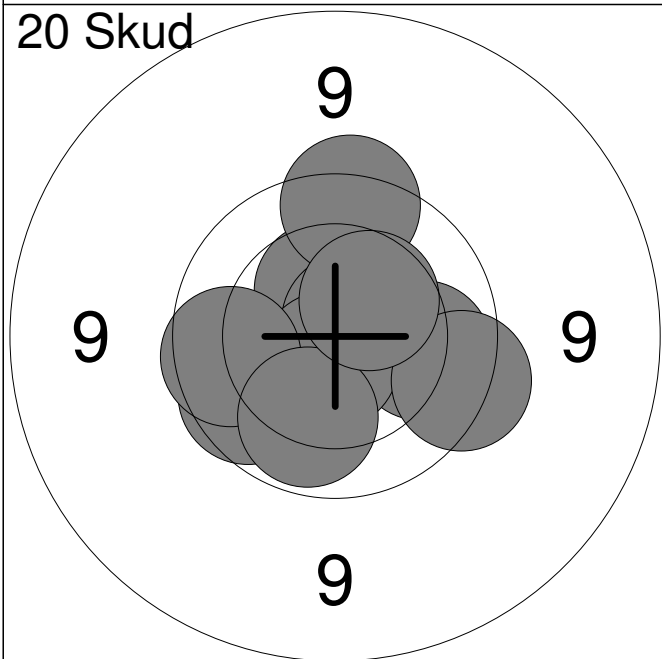

| | | |
|-----|-------|---|
| 1: | 10.4 | ↑ |
| 2: | *10.7 | ↗ |
| 3: | 10.0 | → |
| 4: | *10.7 | ↓ |
| 5: | 9.7 | → |
| 6: | 9.9 | ↙ |
| 7: | 9.7 | ↑ |
| 8: | 9.9 | ← |
| 9: | 10.0 | ↘ |
| 10: | 10.4 | ↗ |

Serie 96.0

Total 96.0

20 Skud

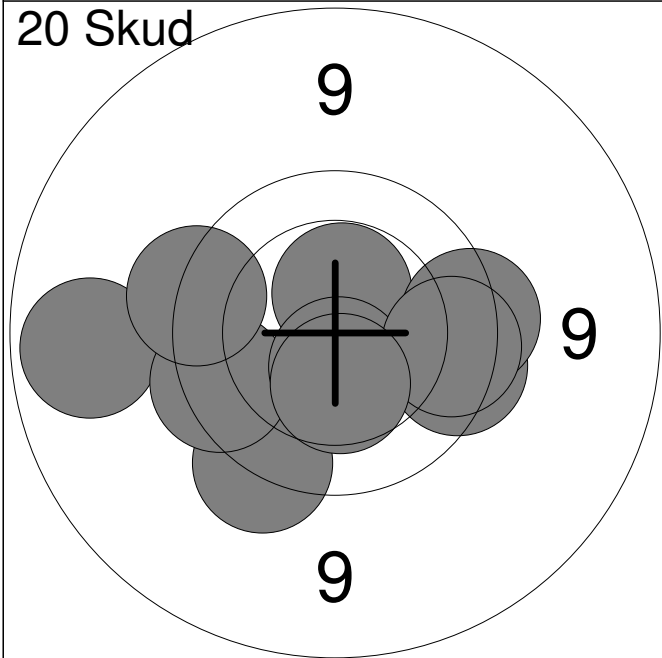

| | | |
|-----|-------|---|
| 11: | 9.6 | ↘ |
| 12: | 9.0 | ← |
| 13: | 9.8 | ↙ |
| 14: | *10.5 | ↑ |
| 15: | 9.6 | ↙ |
| 16: | *10.6 | ↓ |
| 17: | 9.7 | → |
| 18: | 9.7 | → |
| 19: | 9.8 | → |
| 20: | 10.4 | ↓ |

Serie 93.0

Total 189.0

| | | | | | | | | | | | | | | | | | | | | | | | | | | |
|---------------------|--|----|-------|---|----|------|---|----|-----|---|----|-------|---|----|------|---|----|-------|---|----|-----|---|-------|------|-------|-----|
| <p>Prøve</p> | <table style="width:100%; border-collapse: collapse;"> <tr><td style="text-align: right;">1:</td><td style="text-align: right;">*10.6</td><td style="text-align: center;">↗</td></tr> <tr><td style="text-align: right;">2:</td><td style="text-align: right;">10.5</td><td style="text-align: center;">↑</td></tr> <tr><td style="text-align: right;">3:</td><td style="text-align: right;">9.9</td><td style="text-align: center;">→</td></tr> <tr><td style="text-align: right;">4:</td><td style="text-align: right;">*10.5</td><td style="text-align: center;">↘</td></tr> <tr><td style="text-align: right;">5:</td><td style="text-align: right;">10.5</td><td style="text-align: center;">→</td></tr> <tr><td style="text-align: right;">6:</td><td style="text-align: right;">*10.5</td><td style="text-align: center;">↗</td></tr> <tr><td style="text-align: right;">7:</td><td style="text-align: right;">9.9</td><td style="text-align: center;">↘</td></tr> </table> <table border="1" style="width:100%; border-collapse: collapse; margin-top: 5px;"> <tr> <td style="width:80%;">Serie</td> <td style="text-align: right;">68.0</td> </tr> <tr> <td>Total</td> <td style="text-align: right;">0.0</td> </tr> </table> | 1: | *10.6 | ↗ | 2: | 10.5 | ↑ | 3: | 9.9 | → | 4: | *10.5 | ↘ | 5: | 10.5 | → | 6: | *10.5 | ↗ | 7: | 9.9 | ↘ | Serie | 68.0 | Total | 0.0 |
| 1: | *10.6 | ↗ | | | | | | | | | | | | | | | | | | | | | | | | |
| 2: | 10.5 | ↑ | | | | | | | | | | | | | | | | | | | | | | | | |
| 3: | 9.9 | → | | | | | | | | | | | | | | | | | | | | | | | | |
| 4: | *10.5 | ↘ | | | | | | | | | | | | | | | | | | | | | | | | |
| 5: | 10.5 | → | | | | | | | | | | | | | | | | | | | | | | | | |
| 6: | *10.5 | ↗ | | | | | | | | | | | | | | | | | | | | | | | | |
| 7: | 9.9 | ↘ | | | | | | | | | | | | | | | | | | | | | | | | |
| Serie | 68.0 | | | | | | | | | | | | | | | | | | | | | | | | | |
| Total | 0.0 | | | | | | | | | | | | | | | | | | | | | | | | | |

| | | | | | | | | | | | | | | | | | | | | | | | | | | | | | | | | | | | |
|-----------------------|--|----|-------|---|----|-------|---|----|-------|---|----|-------|---|----|-------|---|----|------|---|----|-------|---|----|------|---|----|-------|---|-----|------|---|-------|-------|-------|-------|
| <p>20 Skud</p> | <table style="width:100%; border-collapse: collapse;"> <tr><td style="text-align: right;">1:</td><td style="text-align: right;">*10.5</td><td style="text-align: center;">→</td></tr> <tr><td style="text-align: right;">2:</td><td style="text-align: right;">*10.6</td><td style="text-align: center;">→</td></tr> <tr><td style="text-align: right;">3:</td><td style="text-align: right;">*10.7</td><td style="text-align: center;">↗</td></tr> <tr><td style="text-align: right;">4:</td><td style="text-align: right;">*10.7</td><td style="text-align: center;">↗</td></tr> <tr><td style="text-align: right;">5:</td><td style="text-align: right;">*10.8</td><td style="text-align: center;">→</td></tr> <tr><td style="text-align: right;">6:</td><td style="text-align: right;">10.4</td><td style="text-align: center;">↘</td></tr> <tr><td style="text-align: right;">7:</td><td style="text-align: right;">*10.8</td><td style="text-align: center;">↘</td></tr> <tr><td style="text-align: right;">8:</td><td style="text-align: right;">10.3</td><td style="text-align: center;">←</td></tr> <tr><td style="text-align: right;">9:</td><td style="text-align: right;">*10.8</td><td style="text-align: center;">↘</td></tr> <tr><td style="text-align: right;">10:</td><td style="text-align: right;">10.5</td><td style="text-align: center;">↗</td></tr> </table> <table border="1" style="width:100%; border-collapse: collapse; margin-top: 5px;"> <tr> <td style="width:80%;">Serie</td> <td style="text-align: right;">100.0</td> </tr> <tr> <td>Total</td> <td style="text-align: right;">100.0</td> </tr> </table> | 1: | *10.5 | → | 2: | *10.6 | → | 3: | *10.7 | ↗ | 4: | *10.7 | ↗ | 5: | *10.8 | → | 6: | 10.4 | ↘ | 7: | *10.8 | ↘ | 8: | 10.3 | ← | 9: | *10.8 | ↘ | 10: | 10.5 | ↗ | Serie | 100.0 | Total | 100.0 |
| 1: | *10.5 | → | | | | | | | | | | | | | | | | | | | | | | | | | | | | | | | | | |
| 2: | *10.6 | → | | | | | | | | | | | | | | | | | | | | | | | | | | | | | | | | | |
| 3: | *10.7 | ↗ | | | | | | | | | | | | | | | | | | | | | | | | | | | | | | | | | |
| 4: | *10.7 | ↗ | | | | | | | | | | | | | | | | | | | | | | | | | | | | | | | | | |
| 5: | *10.8 | → | | | | | | | | | | | | | | | | | | | | | | | | | | | | | | | | | |
| 6: | 10.4 | ↘ | | | | | | | | | | | | | | | | | | | | | | | | | | | | | | | | | |
| 7: | *10.8 | ↘ | | | | | | | | | | | | | | | | | | | | | | | | | | | | | | | | | |
| 8: | 10.3 | ← | | | | | | | | | | | | | | | | | | | | | | | | | | | | | | | | | |
| 9: | *10.8 | ↘ | | | | | | | | | | | | | | | | | | | | | | | | | | | | | | | | | |
| 10: | 10.5 | ↗ | | | | | | | | | | | | | | | | | | | | | | | | | | | | | | | | | |
| Serie | 100.0 | | | | | | | | | | | | | | | | | | | | | | | | | | | | | | | | | | |
| Total | 100.0 | | | | | | | | | | | | | | | | | | | | | | | | | | | | | | | | | | |

| | | | | | | | | | | | | | | | | | | | | | | | | | | | | | | | | | | | |
|-----------------------|--|-----|------|---|-----|------|---|-----|-------|---|-----|------|---|-----|-------|---|-----|------|---|-----|------|---|-----|-------|---|-----|-------|---|-----|------|---|-------|-------|-------|-------|
| <p>20 Skud</p> | <table style="width:100%; border-collapse: collapse;"> <tr><td style="text-align: right;">11:</td><td style="text-align: right;">10.2</td><td style="text-align: center;">↗</td></tr> <tr><td style="text-align: right;">12:</td><td style="text-align: right;">10.4</td><td style="text-align: center;">→</td></tr> <tr><td style="text-align: right;">13:</td><td style="text-align: right;">*10.9</td><td style="text-align: center;">↖</td></tr> <tr><td style="text-align: right;">14:</td><td style="text-align: right;">10.2</td><td style="text-align: center;">←</td></tr> <tr><td style="text-align: right;">15:</td><td style="text-align: right;">*10.7</td><td style="text-align: center;">↑</td></tr> <tr><td style="text-align: right;">16:</td><td style="text-align: right;">10.1</td><td style="text-align: center;">↖</td></tr> <tr><td style="text-align: right;">17:</td><td style="text-align: right;">10.3</td><td style="text-align: center;">←</td></tr> <tr><td style="text-align: right;">18:</td><td style="text-align: right;">*10.8</td><td style="text-align: center;">↑</td></tr> <tr><td style="text-align: right;">19:</td><td style="text-align: right;">*10.7</td><td style="text-align: center;">↖</td></tr> <tr><td style="text-align: right;">20:</td><td style="text-align: right;">10.3</td><td style="text-align: center;">↖</td></tr> </table> <table border="1" style="width:100%; border-collapse: collapse; margin-top: 5px;"> <tr> <td style="width:80%;">Serie</td> <td style="text-align: right;">100.0</td> </tr> <tr> <td>Total</td> <td style="text-align: right;">200.0</td> </tr> </table> | 11: | 10.2 | ↗ | 12: | 10.4 | → | 13: | *10.9 | ↖ | 14: | 10.2 | ← | 15: | *10.7 | ↑ | 16: | 10.1 | ↖ | 17: | 10.3 | ← | 18: | *10.8 | ↑ | 19: | *10.7 | ↖ | 20: | 10.3 | ↖ | Serie | 100.0 | Total | 200.0 |
| 11: | 10.2 | ↗ | | | | | | | | | | | | | | | | | | | | | | | | | | | | | | | | | |
| 12: | 10.4 | → | | | | | | | | | | | | | | | | | | | | | | | | | | | | | | | | | |
| 13: | *10.9 | ↖ | | | | | | | | | | | | | | | | | | | | | | | | | | | | | | | | | |
| 14: | 10.2 | ← | | | | | | | | | | | | | | | | | | | | | | | | | | | | | | | | | |
| 15: | *10.7 | ↑ | | | | | | | | | | | | | | | | | | | | | | | | | | | | | | | | | |
| 16: | 10.1 | ↖ | | | | | | | | | | | | | | | | | | | | | | | | | | | | | | | | | |
| 17: | 10.3 | ← | | | | | | | | | | | | | | | | | | | | | | | | | | | | | | | | | |
| 18: | *10.8 | ↑ | | | | | | | | | | | | | | | | | | | | | | | | | | | | | | | | | |
| 19: | *10.7 | ↖ | | | | | | | | | | | | | | | | | | | | | | | | | | | | | | | | | |
| 20: | 10.3 | ↖ | | | | | | | | | | | | | | | | | | | | | | | | | | | | | | | | | |
| Serie | 100.0 | | | | | | | | | | | | | | | | | | | | | | | | | | | | | | | | | | |
| Total | 200.0 | | | | | | | | | | | | | | | | | | | | | | | | | | | | | | | | | | |

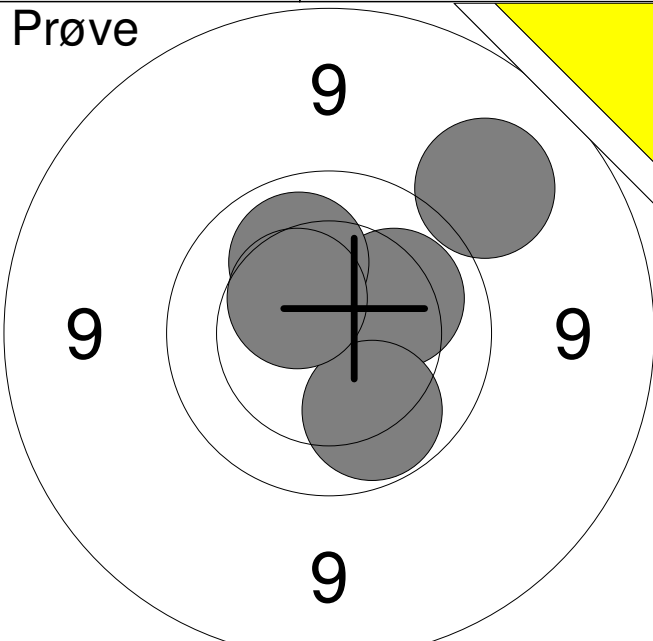
| | | | | | | | | | | | | | | | | |
|--|---|-------|------|-------|-----|------|---|----|------|---|----|------|---|----|------|---|
| <p>Prøve</p>  | <table style="width:100%;"> <tr><td>1:</td><td>9.2</td><td>↗</td></tr> <tr><td>2:</td><td>10.2</td><td>→</td></tr> <tr><td>3:</td><td>10.1</td><td>↗</td></tr> <tr><td>4:</td><td>10.0</td><td>↘</td></tr> <tr><td>5:</td><td>10.4</td><td>↗</td></tr> </table> | 1: | 9.2 | ↗ | 2: | 10.2 | → | 3: | 10.1 | ↗ | 4: | 10.0 | ↘ | 5: | 10.4 | ↗ |
| 1: | 9.2 | ↗ | | | | | | | | | | | | | | |
| 2: | 10.2 | → | | | | | | | | | | | | | | |
| 3: | 10.1 | ↗ | | | | | | | | | | | | | | |
| 4: | 10.0 | ↘ | | | | | | | | | | | | | | |
| 5: | 10.4 | ↗ | | | | | | | | | | | | | | |
| | <table border="1" style="width:100%; border-collapse: collapse;"> <tr> <td style="width:80%;">Serie</td> <td style="text-align: right;">49.0</td> </tr> <tr> <td>Total</td> <td style="text-align: right;">0.0</td> </tr> </table> | Serie | 49.0 | Total | 0.0 | | | | | | | | | | | |
| Serie | 49.0 | | | | | | | | | | | | | | | |
| Total | 0.0 | | | | | | | | | | | | | | | |

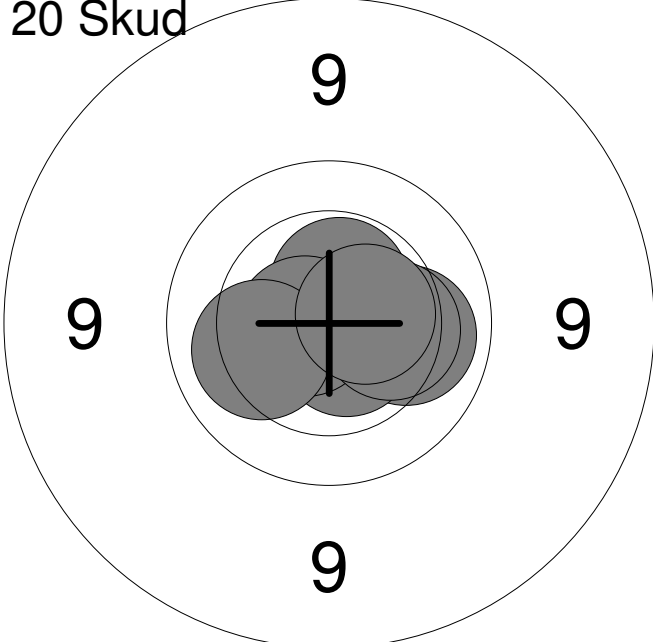
| | | | | | | | | | | | | | | | | | | | | | | | | | | | | | | | |
|---|--|-------|-------|-------|-------|-------|---|----|-------|---|----|-------|---|----|-------|---|----|-------|---|----|-------|---|----|------|---|----|------|---|-----|-------|---|
| <p>20 Skud</p>  | <table style="width:100%;"> <tr><td>1:</td><td>10.1</td><td>→</td></tr> <tr><td>2:</td><td>*10.8</td><td>↖</td></tr> <tr><td>3:</td><td>*10.7</td><td>↘</td></tr> <tr><td>4:</td><td>*10.8</td><td>→</td></tr> <tr><td>5:</td><td>*10.6</td><td>↘</td></tr> <tr><td>6:</td><td>*10.6</td><td>↗</td></tr> <tr><td>7:</td><td>*10.7</td><td>←</td></tr> <tr><td>8:</td><td>10.2</td><td>←</td></tr> <tr><td>9:</td><td>10.3</td><td>→</td></tr> <tr><td>10:</td><td>*10.5</td><td>→</td></tr> </table> | 1: | 10.1 | → | 2: | *10.8 | ↖ | 3: | *10.7 | ↘ | 4: | *10.8 | → | 5: | *10.6 | ↘ | 6: | *10.6 | ↗ | 7: | *10.7 | ← | 8: | 10.2 | ← | 9: | 10.3 | → | 10: | *10.5 | → |
| 1: | 10.1 | → | | | | | | | | | | | | | | | | | | | | | | | | | | | | | |
| 2: | *10.8 | ↖ | | | | | | | | | | | | | | | | | | | | | | | | | | | | | |
| 3: | *10.7 | ↘ | | | | | | | | | | | | | | | | | | | | | | | | | | | | | |
| 4: | *10.8 | → | | | | | | | | | | | | | | | | | | | | | | | | | | | | | |
| 5: | *10.6 | ↘ | | | | | | | | | | | | | | | | | | | | | | | | | | | | | |
| 6: | *10.6 | ↗ | | | | | | | | | | | | | | | | | | | | | | | | | | | | | |
| 7: | *10.7 | ← | | | | | | | | | | | | | | | | | | | | | | | | | | | | | |
| 8: | 10.2 | ← | | | | | | | | | | | | | | | | | | | | | | | | | | | | | |
| 9: | 10.3 | → | | | | | | | | | | | | | | | | | | | | | | | | | | | | | |
| 10: | *10.5 | → | | | | | | | | | | | | | | | | | | | | | | | | | | | | | |
| | <table border="1" style="width:100%; border-collapse: collapse;"> <tr> <td style="width:80%;">Serie</td> <td style="text-align: right;">100.0</td> </tr> <tr> <td>Total</td> <td style="text-align: right;">100.0</td> </tr> </table> | Serie | 100.0 | Total | 100.0 | | | | | | | | | | | | | | | | | | | | | | | | | | |
| Serie | 100.0 | | | | | | | | | | | | | | | | | | | | | | | | | | | | | | |
| Total | 100.0 | | | | | | | | | | | | | | | | | | | | | | | | | | | | | | |

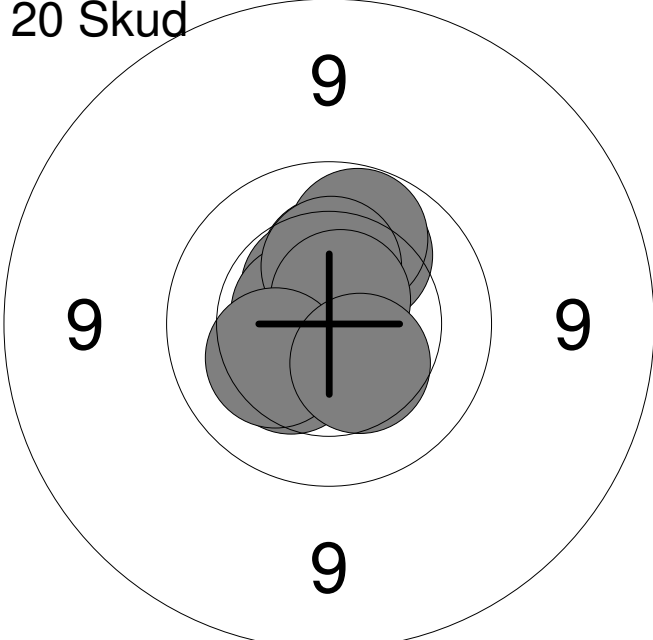
| | | | | | | | | | | | | | | | | | | | | | | | | | | | | | | | |
|--|---|-------|-------|-------|-------|-------|---|-----|------|---|-----|-------|---|-----|------|---|-----|------|---|-----|------|---|-----|-------|---|-----|------|---|-----|------|---|
| <p>20 Skud</p>  | <table style="width:100%;"> <tr><td>11:</td><td>10.3</td><td>↑</td></tr> <tr><td>12:</td><td>*10.5</td><td>↗</td></tr> <tr><td>13:</td><td>10.4</td><td>↖</td></tr> <tr><td>14:</td><td>*10.6</td><td>↖</td></tr> <tr><td>15:</td><td>10.1</td><td>↗</td></tr> <tr><td>16:</td><td>10.0</td><td>↗</td></tr> <tr><td>17:</td><td>10.3</td><td>↑</td></tr> <tr><td>18:</td><td>*10.7</td><td>↗</td></tr> <tr><td>19:</td><td>10.3</td><td>↖</td></tr> <tr><td>20:</td><td>10.4</td><td>↘</td></tr> </table> | 11: | 10.3 | ↑ | 12: | *10.5 | ↗ | 13: | 10.4 | ↖ | 14: | *10.6 | ↖ | 15: | 10.1 | ↗ | 16: | 10.0 | ↗ | 17: | 10.3 | ↑ | 18: | *10.7 | ↗ | 19: | 10.3 | ↖ | 20: | 10.4 | ↘ |
| 11: | 10.3 | ↑ | | | | | | | | | | | | | | | | | | | | | | | | | | | | | |
| 12: | *10.5 | ↗ | | | | | | | | | | | | | | | | | | | | | | | | | | | | | |
| 13: | 10.4 | ↖ | | | | | | | | | | | | | | | | | | | | | | | | | | | | | |
| 14: | *10.6 | ↖ | | | | | | | | | | | | | | | | | | | | | | | | | | | | | |
| 15: | 10.1 | ↗ | | | | | | | | | | | | | | | | | | | | | | | | | | | | | |
| 16: | 10.0 | ↗ | | | | | | | | | | | | | | | | | | | | | | | | | | | | | |
| 17: | 10.3 | ↑ | | | | | | | | | | | | | | | | | | | | | | | | | | | | | |
| 18: | *10.7 | ↗ | | | | | | | | | | | | | | | | | | | | | | | | | | | | | |
| 19: | 10.3 | ↖ | | | | | | | | | | | | | | | | | | | | | | | | | | | | | |
| 20: | 10.4 | ↘ | | | | | | | | | | | | | | | | | | | | | | | | | | | | | |
| | <table border="1" style="width:100%; border-collapse: collapse;"> <tr> <td style="width:80%;">Serie</td> <td style="text-align: right;">100.0</td> </tr> <tr> <td>Total</td> <td style="text-align: right;">200.0</td> </tr> </table> | Serie | 100.0 | Total | 200.0 | | | | | | | | | | | | | | | | | | | | | | | | | | |
| Serie | 100.0 | | | | | | | | | | | | | | | | | | | | | | | | | | | | | | |
| Total | 200.0 | | | | | | | | | | | | | | | | | | | | | | | | | | | | | | |

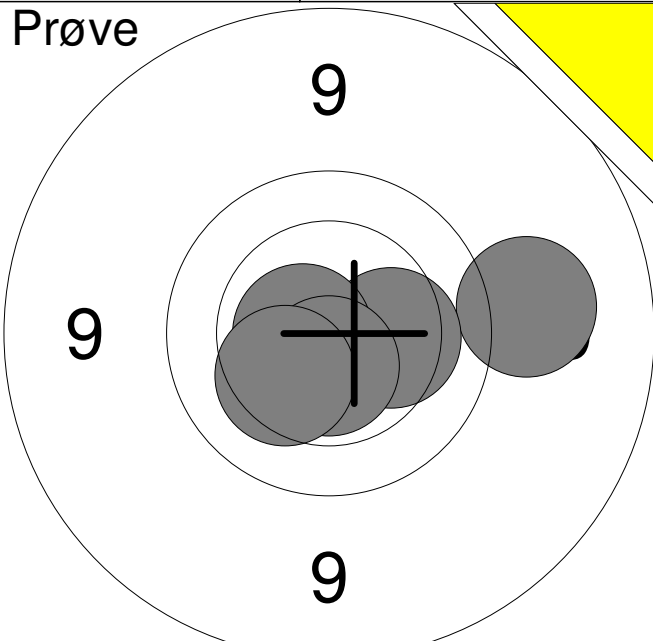
| | | | | | | | | | | | | | | | | | | | | |
|--|---|----|-----|---|----|------|---|----|-------|---|----|-------|---|----|------|---|-------|------|-------|-----|
| <p>Prøve</p>  | <table style="width:100%; border-collapse: collapse;"> <tr><td style="text-align: right;">1:</td><td style="text-align: right;">9.3</td><td style="text-align: right;">→</td></tr> <tr><td style="text-align: right;">2:</td><td style="text-align: right;">10.3</td><td style="text-align: right;">→</td></tr> <tr><td style="text-align: right;">3:</td><td style="text-align: right;">*10.7</td><td style="text-align: right;">←</td></tr> <tr><td style="text-align: right;">4:</td><td style="text-align: right;">*10.6</td><td style="text-align: right;">↓</td></tr> <tr><td style="text-align: right;">5:</td><td style="text-align: right;">10.3</td><td style="text-align: right;">↙</td></tr> </table> <table border="1" style="width:100%; border-collapse: collapse; margin-top: 5px;"> <tr> <td style="width:80%;">Serie</td> <td style="text-align: right;">49.0</td> </tr> <tr> <td>Total</td> <td style="text-align: right;">0.0</td> </tr> </table> | 1: | 9.3 | → | 2: | 10.3 | → | 3: | *10.7 | ← | 4: | *10.6 | ↓ | 5: | 10.3 | ↙ | Serie | 49.0 | Total | 0.0 |
| 1: | 9.3 | → | | | | | | | | | | | | | | | | | | |
| 2: | 10.3 | → | | | | | | | | | | | | | | | | | | |
| 3: | *10.7 | ← | | | | | | | | | | | | | | | | | | |
| 4: | *10.6 | ↓ | | | | | | | | | | | | | | | | | | |
| 5: | 10.3 | ↙ | | | | | | | | | | | | | | | | | | |
| Serie | 49.0 | | | | | | | | | | | | | | | | | | | |
| Total | 0.0 | | | | | | | | | | | | | | | | | | | |

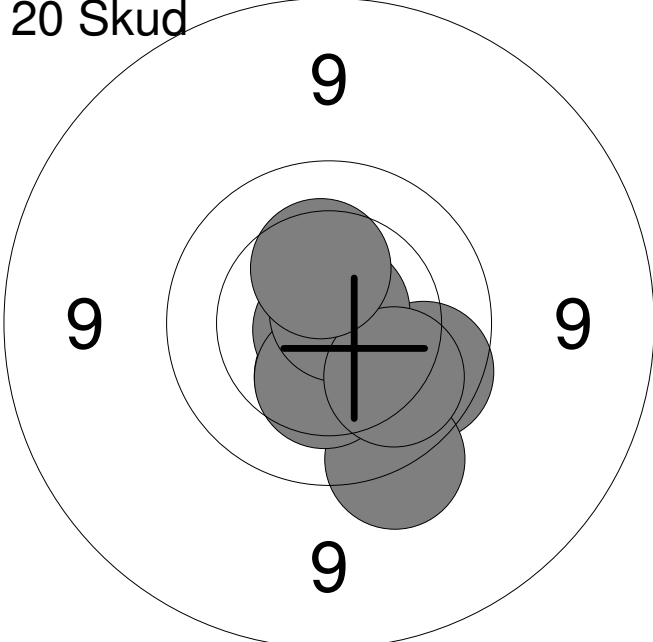
| | | | | | | | | | | | | | | | | | | | | | | | | | | | | | | | | | | | |
|---|---|----|-------|---|----|-----|---|----|------|---|----|-----|---|----|-------|---|----|-----|---|----|------|---|----|-------|---|----|------|---|-----|------|---|-------|------|-------|------|
| <p>20 Skud</p>  | <table style="width:100%; border-collapse: collapse;"> <tr><td style="text-align: right;">1:</td><td style="text-align: right;">*10.5</td><td style="text-align: right;">↓</td></tr> <tr><td style="text-align: right;">2:</td><td style="text-align: right;">9.9</td><td style="text-align: right;">→</td></tr> <tr><td style="text-align: right;">3:</td><td style="text-align: right;">10.4</td><td style="text-align: right;">↓</td></tr> <tr><td style="text-align: right;">4:</td><td style="text-align: right;">9.9</td><td style="text-align: right;">↓</td></tr> <tr><td style="text-align: right;">5:</td><td style="text-align: right;">*10.9</td><td style="text-align: right;">↙</td></tr> <tr><td style="text-align: right;">6:</td><td style="text-align: right;">9.6</td><td style="text-align: right;">↓</td></tr> <tr><td style="text-align: right;">7:</td><td style="text-align: right;">10.4</td><td style="text-align: right;">↓</td></tr> <tr><td style="text-align: right;">8:</td><td style="text-align: right;">*10.8</td><td style="text-align: right;">↗</td></tr> <tr><td style="text-align: right;">9:</td><td style="text-align: right;">10.0</td><td style="text-align: right;">↓</td></tr> <tr><td style="text-align: right;">10:</td><td style="text-align: right;">10.4</td><td style="text-align: right;">↑</td></tr> </table> <table border="1" style="width:100%; border-collapse: collapse; margin-top: 5px;"> <tr> <td style="width:80%;">Serie</td> <td style="text-align: right;">97.0</td> </tr> <tr> <td>Total</td> <td style="text-align: right;">97.0</td> </tr> </table> | 1: | *10.5 | ↓ | 2: | 9.9 | → | 3: | 10.4 | ↓ | 4: | 9.9 | ↓ | 5: | *10.9 | ↙ | 6: | 9.6 | ↓ | 7: | 10.4 | ↓ | 8: | *10.8 | ↗ | 9: | 10.0 | ↓ | 10: | 10.4 | ↑ | Serie | 97.0 | Total | 97.0 |
| 1: | *10.5 | ↓ | | | | | | | | | | | | | | | | | | | | | | | | | | | | | | | | | |
| 2: | 9.9 | → | | | | | | | | | | | | | | | | | | | | | | | | | | | | | | | | | |
| 3: | 10.4 | ↓ | | | | | | | | | | | | | | | | | | | | | | | | | | | | | | | | | |
| 4: | 9.9 | ↓ | | | | | | | | | | | | | | | | | | | | | | | | | | | | | | | | | |
| 5: | *10.9 | ↙ | | | | | | | | | | | | | | | | | | | | | | | | | | | | | | | | | |
| 6: | 9.6 | ↓ | | | | | | | | | | | | | | | | | | | | | | | | | | | | | | | | | |
| 7: | 10.4 | ↓ | | | | | | | | | | | | | | | | | | | | | | | | | | | | | | | | | |
| 8: | *10.8 | ↗ | | | | | | | | | | | | | | | | | | | | | | | | | | | | | | | | | |
| 9: | 10.0 | ↓ | | | | | | | | | | | | | | | | | | | | | | | | | | | | | | | | | |
| 10: | 10.4 | ↑ | | | | | | | | | | | | | | | | | | | | | | | | | | | | | | | | | |
| Serie | 97.0 | | | | | | | | | | | | | | | | | | | | | | | | | | | | | | | | | | |
| Total | 97.0 | | | | | | | | | | | | | | | | | | | | | | | | | | | | | | | | | | |

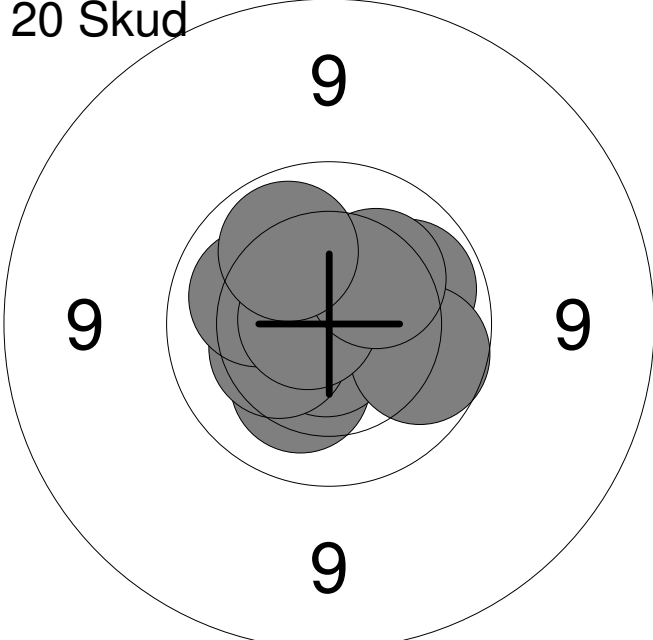
| | | | | | | | | | | | | | | | | | | | | | | | | | | | | | | | | | | | |
|--|---|-----|------|---|-----|------|---|-----|-------|---|-----|-------|---|-----|-----|---|-----|------|---|-----|------|---|-----|-------|---|-----|------|---|-----|------|---|-------|------|-------|-------|
| <p>20 Skud</p>  | <table style="width:100%; border-collapse: collapse;"> <tr><td style="text-align: right;">11:</td><td style="text-align: right;">10.2</td><td style="text-align: right;">↙</td></tr> <tr><td style="text-align: right;">12:</td><td style="text-align: right;">10.0</td><td style="text-align: right;">→</td></tr> <tr><td style="text-align: right;">13:</td><td style="text-align: right;">*10.7</td><td style="text-align: right;">↗</td></tr> <tr><td style="text-align: right;">14:</td><td style="text-align: right;">*10.7</td><td style="text-align: right;">↓</td></tr> <tr><td style="text-align: right;">15:</td><td style="text-align: right;">9.9</td><td style="text-align: right;">→</td></tr> <tr><td style="text-align: right;">16:</td><td style="text-align: right;">10.3</td><td style="text-align: right;">←</td></tr> <tr><td style="text-align: right;">17:</td><td style="text-align: right;">10.1</td><td style="text-align: right;">↗</td></tr> <tr><td style="text-align: right;">18:</td><td style="text-align: right;">*10.7</td><td style="text-align: right;">←</td></tr> <tr><td style="text-align: right;">19:</td><td style="text-align: right;">10.2</td><td style="text-align: right;">↗</td></tr> <tr><td style="text-align: right;">20:</td><td style="text-align: right;">10.1</td><td style="text-align: right;">↗</td></tr> </table> <table border="1" style="width:100%; border-collapse: collapse; margin-top: 5px;"> <tr> <td style="width:80%;">Serie</td> <td style="text-align: right;">99.0</td> </tr> <tr> <td>Total</td> <td style="text-align: right;">196.0</td> </tr> </table> | 11: | 10.2 | ↙ | 12: | 10.0 | → | 13: | *10.7 | ↗ | 14: | *10.7 | ↓ | 15: | 9.9 | → | 16: | 10.3 | ← | 17: | 10.1 | ↗ | 18: | *10.7 | ← | 19: | 10.2 | ↗ | 20: | 10.1 | ↗ | Serie | 99.0 | Total | 196.0 |
| 11: | 10.2 | ↙ | | | | | | | | | | | | | | | | | | | | | | | | | | | | | | | | | |
| 12: | 10.0 | → | | | | | | | | | | | | | | | | | | | | | | | | | | | | | | | | | |
| 13: | *10.7 | ↗ | | | | | | | | | | | | | | | | | | | | | | | | | | | | | | | | | |
| 14: | *10.7 | ↓ | | | | | | | | | | | | | | | | | | | | | | | | | | | | | | | | | |
| 15: | 9.9 | → | | | | | | | | | | | | | | | | | | | | | | | | | | | | | | | | | |
| 16: | 10.3 | ← | | | | | | | | | | | | | | | | | | | | | | | | | | | | | | | | | |
| 17: | 10.1 | ↗ | | | | | | | | | | | | | | | | | | | | | | | | | | | | | | | | | |
| 18: | *10.7 | ← | | | | | | | | | | | | | | | | | | | | | | | | | | | | | | | | | |
| 19: | 10.2 | ↗ | | | | | | | | | | | | | | | | | | | | | | | | | | | | | | | | | |
| 20: | 10.1 | ↗ | | | | | | | | | | | | | | | | | | | | | | | | | | | | | | | | | |
| Serie | 99.0 | | | | | | | | | | | | | | | | | | | | | | | | | | | | | | | | | | |
| Total | 196.0 | | | | | | | | | | | | | | | | | | | | | | | | | | | | | | | | | | |

| | | | | | | | | | | | | | | | | | | | | | | |
|---|---|-------|-----|------|-------|-----|-----|----|-----|---|----|-----|---|----|-----|---|----|-----|---|----|------|---|
| <p>Prøve</p> | <table style="width:100%; border-collapse: collapse;"> <tr><td style="width:10%;">1:</td><td style="width:15%;">9.9</td><td style="width:10%; text-align: right;">↗</td></tr> <tr><td>2:</td><td>8.8</td><td style="text-align: right;">↗</td></tr> <tr><td>3:</td><td>9.0</td><td style="text-align: right;">↘</td></tr> <tr><td>4:</td><td>9.8</td><td style="text-align: right;">→</td></tr> <tr><td>5:</td><td>9.4</td><td style="text-align: right;">↖</td></tr> <tr><td>6:</td><td>9.5</td><td style="text-align: right;">→</td></tr> <tr><td>7:</td><td>10.4</td><td style="text-align: right;">↗</td></tr> </table> | 1: | 9.9 | ↗ | 2: | 8.8 | ↗ | 3: | 9.0 | ↘ | 4: | 9.8 | → | 5: | 9.4 | ↖ | 6: | 9.5 | → | 7: | 10.4 | ↗ |
| 1: | 9.9 | ↗ | | | | | | | | | | | | | | | | | | | | |
| 2: | 8.8 | ↗ | | | | | | | | | | | | | | | | | | | | |
| 3: | 9.0 | ↘ | | | | | | | | | | | | | | | | | | | | |
| 4: | 9.8 | → | | | | | | | | | | | | | | | | | | | | |
| 5: | 9.4 | ↖ | | | | | | | | | | | | | | | | | | | | |
| 6: | 9.5 | → | | | | | | | | | | | | | | | | | | | | |
| 7: | 10.4 | ↗ | | | | | | | | | | | | | | | | | | | | |
| <table style="width:100%; border-collapse: collapse;"> <tr> <td style="width:10%;">Serie</td> <td style="width:80%;"></td> <td style="width:10%; text-align: right;">63.0</td> </tr> <tr> <td>Total</td> <td></td> <td style="text-align: right;">0.0</td> </tr> </table> | | Serie | | 63.0 | Total | | 0.0 | | | | | | | | | | | | | | | |
| Serie | | 63.0 | | | | | | | | | | | | | | | | | | | | |
| Total | | 0.0 | | | | | | | | | | | | | | | | | | | | |

| | | | | | | | | | | | | | | | | | | | | | | | | | | | | | | | |
|--|---|-------|-----|------|-------|------|------|----|-----|---|----|-----|---|----|------|---|----|-----|---|----|-----|---|----|-----|---|----|-----|---|-----|-----|---|
| <p>20 Skud</p> | <table style="width:100%; border-collapse: collapse;"> <tr><td style="width:10%;">1:</td><td style="width:15%;">8.4</td><td style="width:10%; text-align: right;">↖</td></tr> <tr><td>2:</td><td>10.0</td><td style="text-align: right;">↗</td></tr> <tr><td>3:</td><td>9.8</td><td style="text-align: right;">↗</td></tr> <tr><td>4:</td><td>9.1</td><td style="text-align: right;">→</td></tr> <tr><td>5:</td><td>10.4</td><td style="text-align: right;">↘</td></tr> <tr><td>6:</td><td>8.8</td><td style="text-align: right;">↗</td></tr> <tr><td>7:</td><td>9.6</td><td style="text-align: right;">↘</td></tr> <tr><td>8:</td><td>9.1</td><td style="text-align: right;">↘</td></tr> <tr><td>9:</td><td>9.6</td><td style="text-align: right;">→</td></tr> <tr><td>10:</td><td>9.5</td><td style="text-align: right;">↘</td></tr> </table> | 1: | 8.4 | ↖ | 2: | 10.0 | ↗ | 3: | 9.8 | ↗ | 4: | 9.1 | → | 5: | 10.4 | ↘ | 6: | 8.8 | ↗ | 7: | 9.6 | ↘ | 8: | 9.1 | ↘ | 9: | 9.6 | → | 10: | 9.5 | ↘ |
| 1: | 8.4 | ↖ | | | | | | | | | | | | | | | | | | | | | | | | | | | | | |
| 2: | 10.0 | ↗ | | | | | | | | | | | | | | | | | | | | | | | | | | | | | |
| 3: | 9.8 | ↗ | | | | | | | | | | | | | | | | | | | | | | | | | | | | | |
| 4: | 9.1 | → | | | | | | | | | | | | | | | | | | | | | | | | | | | | | |
| 5: | 10.4 | ↘ | | | | | | | | | | | | | | | | | | | | | | | | | | | | | |
| 6: | 8.8 | ↗ | | | | | | | | | | | | | | | | | | | | | | | | | | | | | |
| 7: | 9.6 | ↘ | | | | | | | | | | | | | | | | | | | | | | | | | | | | | |
| 8: | 9.1 | ↘ | | | | | | | | | | | | | | | | | | | | | | | | | | | | | |
| 9: | 9.6 | → | | | | | | | | | | | | | | | | | | | | | | | | | | | | | |
| 10: | 9.5 | ↘ | | | | | | | | | | | | | | | | | | | | | | | | | | | | | |
| <table style="width:100%; border-collapse: collapse;"> <tr> <td style="width:10%;">Serie</td> <td style="width:80%;"></td> <td style="width:10%; text-align: right;">90.0</td> </tr> <tr> <td>Total</td> <td></td> <td style="text-align: right;">90.0</td> </tr> </table> | | Serie | | 90.0 | Total | | 90.0 | | | | | | | | | | | | | | | | | | | | | | | | |
| Serie | | 90.0 | | | | | | | | | | | | | | | | | | | | | | | | | | | | | |
| Total | | 90.0 | | | | | | | | | | | | | | | | | | | | | | | | | | | | | |

| | | | | | | | | | | | | | | | | | | | | | | | | | | | | | | | |
|---|---|-------|-------|------|-------|-----|-------|-----|-----|---|-----|------|---|-----|-------|---|-----|-----|---|-----|------|---|-----|-------|---|-----|------|---|-----|-----|---|
| <p>20 Skud</p> | <table style="width:100%; border-collapse: collapse;"> <tr><td style="width:10%;">11:</td><td style="width:15%;">*10.8</td><td style="width:10%; text-align: right;">↗</td></tr> <tr><td>12:</td><td>9.0</td><td style="text-align: right;">↗</td></tr> <tr><td>13:</td><td>9.9</td><td style="text-align: right;">→</td></tr> <tr><td>14:</td><td>10.0</td><td style="text-align: right;">↘</td></tr> <tr><td>15:</td><td>*10.6</td><td style="text-align: right;">↘</td></tr> <tr><td>16:</td><td>9.2</td><td style="text-align: right;">↗</td></tr> <tr><td>17:</td><td>10.1</td><td style="text-align: right;">↗</td></tr> <tr><td>18:</td><td>*10.5</td><td style="text-align: right;">→</td></tr> <tr><td>19:</td><td>10.0</td><td style="text-align: right;">↗</td></tr> <tr><td>20:</td><td>9.3</td><td style="text-align: right;">→</td></tr> </table> | 11: | *10.8 | ↗ | 12: | 9.0 | ↗ | 13: | 9.9 | → | 14: | 10.0 | ↘ | 15: | *10.6 | ↘ | 16: | 9.2 | ↗ | 17: | 10.1 | ↗ | 18: | *10.5 | → | 19: | 10.0 | ↗ | 20: | 9.3 | → |
| 11: | *10.8 | ↗ | | | | | | | | | | | | | | | | | | | | | | | | | | | | | |
| 12: | 9.0 | ↗ | | | | | | | | | | | | | | | | | | | | | | | | | | | | | |
| 13: | 9.9 | → | | | | | | | | | | | | | | | | | | | | | | | | | | | | | |
| 14: | 10.0 | ↘ | | | | | | | | | | | | | | | | | | | | | | | | | | | | | |
| 15: | *10.6 | ↘ | | | | | | | | | | | | | | | | | | | | | | | | | | | | | |
| 16: | 9.2 | ↗ | | | | | | | | | | | | | | | | | | | | | | | | | | | | | |
| 17: | 10.1 | ↗ | | | | | | | | | | | | | | | | | | | | | | | | | | | | | |
| 18: | *10.5 | → | | | | | | | | | | | | | | | | | | | | | | | | | | | | | |
| 19: | 10.0 | ↗ | | | | | | | | | | | | | | | | | | | | | | | | | | | | | |
| 20: | 9.3 | → | | | | | | | | | | | | | | | | | | | | | | | | | | | | | |
| <table style="width:100%; border-collapse: collapse;"> <tr> <td style="width:10%;">Serie</td> <td style="width:80%;"></td> <td style="width:10%; text-align: right;">96.0</td> </tr> <tr> <td>Total</td> <td></td> <td style="text-align: right;">186.0</td> </tr> </table> | | Serie | | 96.0 | Total | | 186.0 | | | | | | | | | | | | | | | | | | | | | | | | |
| Serie | | 96.0 | | | | | | | | | | | | | | | | | | | | | | | | | | | | | |
| Total | | 186.0 | | | | | | | | | | | | | | | | | | | | | | | | | | | | | |

| | | | | | | | | | | | | | | | | | | | | | | | | | | |
|---------------------|--|----|------|---|----|-------|---|----|-------|---|----|-------|---|----|------|---|----|------|---|----|-------|---|-------|------|-------|-----|
| <p>Prøve</p> | <table style="width:100%; border-collapse: collapse;"> <tr><td style="width:10%;">1:</td><td style="width:20%;">10.1</td><td style="width:10%; text-align: right;">↓</td></tr> <tr><td>2:</td><td>*10.5</td><td style="text-align: right;">↓</td></tr> <tr><td>3:</td><td>*10.5</td><td style="text-align: right;">↓</td></tr> <tr><td>4:</td><td>*10.8</td><td style="text-align: right;">↓</td></tr> <tr><td>5:</td><td>10.1</td><td style="text-align: right;">↓</td></tr> <tr><td>6:</td><td>10.3</td><td style="text-align: right;">↓</td></tr> <tr><td>7:</td><td>*10.7</td><td style="text-align: right;">↑</td></tr> </table> <table border="1" style="width:100%; border-collapse: collapse; margin-top: 10px;"> <tr> <td style="width:80%;">Serie</td> <td style="text-align: right;">70.0</td> </tr> <tr> <td>Total</td> <td style="text-align: right;">0.0</td> </tr> </table> | 1: | 10.1 | ↓ | 2: | *10.5 | ↓ | 3: | *10.5 | ↓ | 4: | *10.8 | ↓ | 5: | 10.1 | ↓ | 6: | 10.3 | ↓ | 7: | *10.7 | ↑ | Serie | 70.0 | Total | 0.0 |
| 1: | 10.1 | ↓ | | | | | | | | | | | | | | | | | | | | | | | | |
| 2: | *10.5 | ↓ | | | | | | | | | | | | | | | | | | | | | | | | |
| 3: | *10.5 | ↓ | | | | | | | | | | | | | | | | | | | | | | | | |
| 4: | *10.8 | ↓ | | | | | | | | | | | | | | | | | | | | | | | | |
| 5: | 10.1 | ↓ | | | | | | | | | | | | | | | | | | | | | | | | |
| 6: | 10.3 | ↓ | | | | | | | | | | | | | | | | | | | | | | | | |
| 7: | *10.7 | ↑ | | | | | | | | | | | | | | | | | | | | | | | | |
| Serie | 70.0 | | | | | | | | | | | | | | | | | | | | | | | | | |
| Total | 0.0 | | | | | | | | | | | | | | | | | | | | | | | | | |

| | | | | | | | | | | | | | | | | | | | | | | | | | | | | | | | | | | | |
|-----------------------|--|----|-------|---|----|-----|---|----|------|---|----|-------|---|----|-----|---|----|-------|---|----|------|---|----|------|---|----|------|---|-----|------|---|-------|------|-------|------|
| <p>20 Skud</p> | <table style="width:100%; border-collapse: collapse;"> <tr><td style="width:10%;">1:</td><td style="width:20%;">*10.9</td><td style="width:10%; text-align: right;">↑</td></tr> <tr><td>2:</td><td>9.9</td><td style="text-align: right;">→</td></tr> <tr><td>3:</td><td>10.4</td><td style="text-align: right;">↓</td></tr> <tr><td>4:</td><td>*10.7</td><td style="text-align: right;">↓</td></tr> <tr><td>5:</td><td>9.6</td><td style="text-align: right;">↑</td></tr> <tr><td>6:</td><td>*10.6</td><td style="text-align: right;">←</td></tr> <tr><td>7:</td><td>10.3</td><td style="text-align: right;">↑</td></tr> <tr><td>8:</td><td>10.2</td><td style="text-align: right;">←</td></tr> <tr><td>9:</td><td>10.1</td><td style="text-align: right;">←</td></tr> <tr><td>10:</td><td>10.4</td><td style="text-align: right;">↑</td></tr> </table> <table border="1" style="width:100%; border-collapse: collapse; margin-top: 10px;"> <tr> <td style="width:80%;">Serie</td> <td style="text-align: right;">98.0</td> </tr> <tr> <td>Total</td> <td style="text-align: right;">98.0</td> </tr> </table> | 1: | *10.9 | ↑ | 2: | 9.9 | → | 3: | 10.4 | ↓ | 4: | *10.7 | ↓ | 5: | 9.6 | ↑ | 6: | *10.6 | ← | 7: | 10.3 | ↑ | 8: | 10.2 | ← | 9: | 10.1 | ← | 10: | 10.4 | ↑ | Serie | 98.0 | Total | 98.0 |
| 1: | *10.9 | ↑ | | | | | | | | | | | | | | | | | | | | | | | | | | | | | | | | | |
| 2: | 9.9 | → | | | | | | | | | | | | | | | | | | | | | | | | | | | | | | | | | |
| 3: | 10.4 | ↓ | | | | | | | | | | | | | | | | | | | | | | | | | | | | | | | | | |
| 4: | *10.7 | ↓ | | | | | | | | | | | | | | | | | | | | | | | | | | | | | | | | | |
| 5: | 9.6 | ↑ | | | | | | | | | | | | | | | | | | | | | | | | | | | | | | | | | |
| 6: | *10.6 | ← | | | | | | | | | | | | | | | | | | | | | | | | | | | | | | | | | |
| 7: | 10.3 | ↑ | | | | | | | | | | | | | | | | | | | | | | | | | | | | | | | | | |
| 8: | 10.2 | ← | | | | | | | | | | | | | | | | | | | | | | | | | | | | | | | | | |
| 9: | 10.1 | ← | | | | | | | | | | | | | | | | | | | | | | | | | | | | | | | | | |
| 10: | 10.4 | ↑ | | | | | | | | | | | | | | | | | | | | | | | | | | | | | | | | | |
| Serie | 98.0 | | | | | | | | | | | | | | | | | | | | | | | | | | | | | | | | | | |
| Total | 98.0 | | | | | | | | | | | | | | | | | | | | | | | | | | | | | | | | | | |

| | | | | | | | | | | | | | | | | | | | | | | | | | | | | | | | | | | | |
|-----------------------|---|-----|------|---|-----|------|---|-----|------|---|-----|------|---|-----|------|---|-----|-----|---|-----|------|---|-----|-----|---|-----|------|---|-----|------|---|-------|------|-------|-------|
| <p>20 Skud</p> | <table style="width:100%; border-collapse: collapse;"> <tr><td style="width:10%;">11:</td><td style="width:20%;">10.1</td><td style="width:10%; text-align: right;">↑</td></tr> <tr><td>12:</td><td>10.1</td><td style="text-align: right;">←</td></tr> <tr><td>13:</td><td>10.4</td><td style="text-align: right;">↑</td></tr> <tr><td>14:</td><td>10.1</td><td style="text-align: right;">←</td></tr> <tr><td>15:</td><td>10.3</td><td style="text-align: right;">→</td></tr> <tr><td>16:</td><td>9.8</td><td style="text-align: right;">↑</td></tr> <tr><td>17:</td><td>10.2</td><td style="text-align: right;">↑</td></tr> <tr><td>18:</td><td>9.9</td><td style="text-align: right;">→</td></tr> <tr><td>19:</td><td>10.4</td><td style="text-align: right;">↑</td></tr> <tr><td>20:</td><td>10.0</td><td style="text-align: right;">→</td></tr> </table> <table border="1" style="width:100%; border-collapse: collapse; margin-top: 10px;"> <tr> <td style="width:80%;">Serie</td> <td style="text-align: right;">98.0</td> </tr> <tr> <td>Total</td> <td style="text-align: right;">196.0</td> </tr> </table> | 11: | 10.1 | ↑ | 12: | 10.1 | ← | 13: | 10.4 | ↑ | 14: | 10.1 | ← | 15: | 10.3 | → | 16: | 9.8 | ↑ | 17: | 10.2 | ↑ | 18: | 9.9 | → | 19: | 10.4 | ↑ | 20: | 10.0 | → | Serie | 98.0 | Total | 196.0 |
| 11: | 10.1 | ↑ | | | | | | | | | | | | | | | | | | | | | | | | | | | | | | | | | |
| 12: | 10.1 | ← | | | | | | | | | | | | | | | | | | | | | | | | | | | | | | | | | |
| 13: | 10.4 | ↑ | | | | | | | | | | | | | | | | | | | | | | | | | | | | | | | | | |
| 14: | 10.1 | ← | | | | | | | | | | | | | | | | | | | | | | | | | | | | | | | | | |
| 15: | 10.3 | → | | | | | | | | | | | | | | | | | | | | | | | | | | | | | | | | | |
| 16: | 9.8 | ↑ | | | | | | | | | | | | | | | | | | | | | | | | | | | | | | | | | |
| 17: | 10.2 | ↑ | | | | | | | | | | | | | | | | | | | | | | | | | | | | | | | | | |
| 18: | 9.9 | → | | | | | | | | | | | | | | | | | | | | | | | | | | | | | | | | | |
| 19: | 10.4 | ↑ | | | | | | | | | | | | | | | | | | | | | | | | | | | | | | | | | |
| 20: | 10.0 | → | | | | | | | | | | | | | | | | | | | | | | | | | | | | | | | | | |
| Serie | 98.0 | | | | | | | | | | | | | | | | | | | | | | | | | | | | | | | | | | |
| Total | 196.0 | | | | | | | | | | | | | | | | | | | | | | | | | | | | | | | | | | |

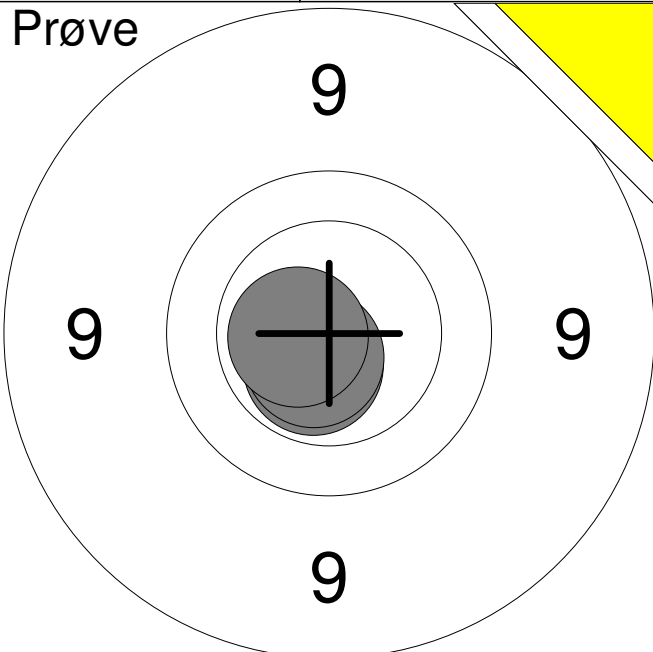
| | | |
|--|--------------|-------------|
| Prøve  | 1: *10.6 | ↙ |
| | 2: *10.6 | ↙ |
| | 3: *10.6 | ← |
| | Serie | 30.0 |
| Total | 0.0 | |

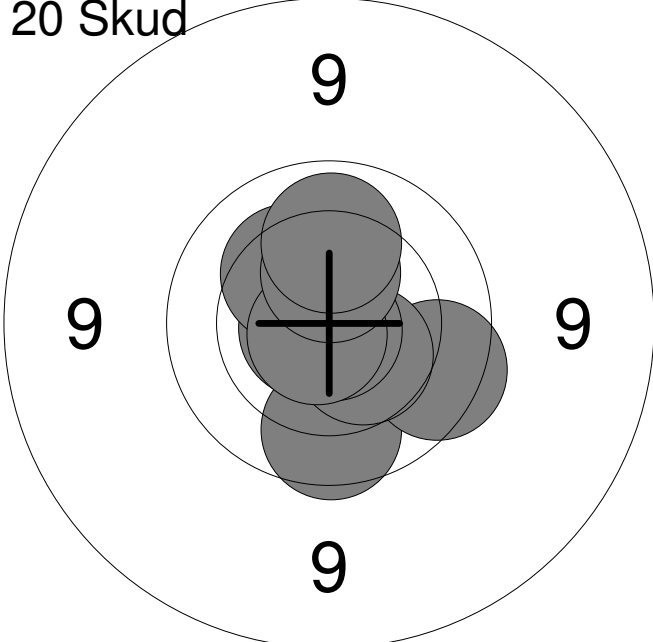
| | | |
|---|--------------|-------------|
| 20 Skud  | 1: 9.9 | ↓ |
| | 2: *10.8 | ↙ |
| | 3: 9.8 | → |
| | 4: *10.7 | ← |
| | 5: 10.4 | ↘ |
| | 6: 10.3 | ↗ |
| | 7: *10.9 | ↓ |
| | 8: *10.8 | ↙ |
| | 9: 10.4 | ↑ |
| | 10: 10.1 | ↑ |
| | Serie | 98.0 |
| Total | 98.0 | |

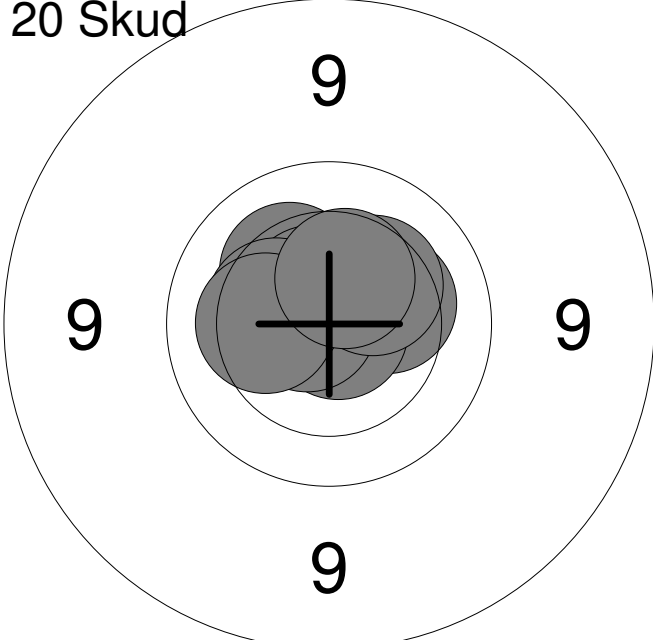
| | | |
|--|--------------|--------------|
| 20 Skud  | 11: 10.3 | → |
| | 12: *10.6 | ↑ |
| | 13: *10.8 | ↘ |
| | 14: 10.3 | ↗ |
| | 15: *10.6 | ↗ |
| | 16: *10.7 | ← |
| | 17: 10.3 | ↗ |
| | 18: 10.4 | ← |
| | 19: 10.3 | ← |
| | 20: 10.4 | ↑ |
| | Serie | 100.0 |
| Total | 198.0 | |

| | | | | | | | | | | | | | | | | | | | | | | | | | | | | | | | | |
|---------------------|---|----|-----|---|----|-----|---|----|------|---|----|------|---|----|-----|---|----|-----|---|----|-----|---|----|-------|---|----|-------|---|-------|------|-------|-----|
| <p>Prøve</p> | <table style="width:100%; border-collapse: collapse;"> <tr><td style="text-align: right;">1:</td><td style="text-align: right;">9.8</td><td style="text-align: right;">↗</td></tr> <tr><td style="text-align: right;">2:</td><td style="text-align: right;">9.9</td><td style="text-align: right;">↑</td></tr> <tr><td style="text-align: right;">3:</td><td style="text-align: right;">10.1</td><td style="text-align: right;">↗</td></tr> <tr><td style="text-align: right;">4:</td><td style="text-align: right;">10.3</td><td style="text-align: right;">↓</td></tr> <tr><td style="text-align: right;">5:</td><td style="text-align: right;">9.9</td><td style="text-align: right;">↓</td></tr> <tr><td style="text-align: right;">6:</td><td style="text-align: right;">9.2</td><td style="text-align: right;">→</td></tr> <tr><td style="text-align: right;">7:</td><td style="text-align: right;">9.9</td><td style="text-align: right;">→</td></tr> <tr><td style="text-align: right;">8:</td><td style="text-align: right;">*10.8</td><td style="text-align: right;">↘</td></tr> <tr><td style="text-align: right;">9:</td><td style="text-align: right;">*10.8</td><td style="text-align: right;">→</td></tr> </table> <table border="1" style="width:100%; border-collapse: collapse; margin-top: 5px;"> <tr> <td style="width:80%;">Serie</td> <td style="text-align: right;">85.0</td> </tr> <tr> <td>Total</td> <td style="text-align: right;">0.0</td> </tr> </table> | 1: | 9.8 | ↗ | 2: | 9.9 | ↑ | 3: | 10.1 | ↗ | 4: | 10.3 | ↓ | 5: | 9.9 | ↓ | 6: | 9.2 | → | 7: | 9.9 | → | 8: | *10.8 | ↘ | 9: | *10.8 | → | Serie | 85.0 | Total | 0.0 |
| 1: | 9.8 | ↗ | | | | | | | | | | | | | | | | | | | | | | | | | | | | | | |
| 2: | 9.9 | ↑ | | | | | | | | | | | | | | | | | | | | | | | | | | | | | | |
| 3: | 10.1 | ↗ | | | | | | | | | | | | | | | | | | | | | | | | | | | | | | |
| 4: | 10.3 | ↓ | | | | | | | | | | | | | | | | | | | | | | | | | | | | | | |
| 5: | 9.9 | ↓ | | | | | | | | | | | | | | | | | | | | | | | | | | | | | | |
| 6: | 9.2 | → | | | | | | | | | | | | | | | | | | | | | | | | | | | | | | |
| 7: | 9.9 | → | | | | | | | | | | | | | | | | | | | | | | | | | | | | | | |
| 8: | *10.8 | ↘ | | | | | | | | | | | | | | | | | | | | | | | | | | | | | | |
| 9: | *10.8 | → | | | | | | | | | | | | | | | | | | | | | | | | | | | | | | |
| Serie | 85.0 | | | | | | | | | | | | | | | | | | | | | | | | | | | | | | | |
| Total | 0.0 | | | | | | | | | | | | | | | | | | | | | | | | | | | | | | | |

| | | | | | | | | | | | | | | | | | | | | | | | | | | | | | | | | | | | |
|-----------------------|---|----|------|---|----|------|---|----|------|---|----|------|---|----|-----|---|----|-----|---|----|-----|---|----|-----|---|----|-----|---|-----|-----|---|-------|------|-------|------|
| <p>20 Skud</p> | <table style="width:100%; border-collapse: collapse;"> <tr><td style="text-align: right;">1:</td><td style="text-align: right;">10.3</td><td style="text-align: right;">→</td></tr> <tr><td style="text-align: right;">2:</td><td style="text-align: right;">10.4</td><td style="text-align: right;">↘</td></tr> <tr><td style="text-align: right;">3:</td><td style="text-align: right;">10.3</td><td style="text-align: right;">←</td></tr> <tr><td style="text-align: right;">4:</td><td style="text-align: right;">10.5</td><td style="text-align: right;">↗</td></tr> <tr><td style="text-align: right;">5:</td><td style="text-align: right;">9.5</td><td style="text-align: right;">↖</td></tr> <tr><td style="text-align: right;">6:</td><td style="text-align: right;">9.7</td><td style="text-align: right;">←</td></tr> <tr><td style="text-align: right;">7:</td><td style="text-align: right;">9.7</td><td style="text-align: right;">↘</td></tr> <tr><td style="text-align: right;">8:</td><td style="text-align: right;">9.8</td><td style="text-align: right;">←</td></tr> <tr><td style="text-align: right;">9:</td><td style="text-align: right;">9.8</td><td style="text-align: right;">↘</td></tr> <tr><td style="text-align: right;">10:</td><td style="text-align: right;">9.6</td><td style="text-align: right;">↖</td></tr> </table> <table border="1" style="width:100%; border-collapse: collapse; margin-top: 5px;"> <tr> <td style="width:80%;">Serie</td> <td style="text-align: right;">94.0</td> </tr> <tr> <td>Total</td> <td style="text-align: right;">94.0</td> </tr> </table> | 1: | 10.3 | → | 2: | 10.4 | ↘ | 3: | 10.3 | ← | 4: | 10.5 | ↗ | 5: | 9.5 | ↖ | 6: | 9.7 | ← | 7: | 9.7 | ↘ | 8: | 9.8 | ← | 9: | 9.8 | ↘ | 10: | 9.6 | ↖ | Serie | 94.0 | Total | 94.0 |
| 1: | 10.3 | → | | | | | | | | | | | | | | | | | | | | | | | | | | | | | | | | | |
| 2: | 10.4 | ↘ | | | | | | | | | | | | | | | | | | | | | | | | | | | | | | | | | |
| 3: | 10.3 | ← | | | | | | | | | | | | | | | | | | | | | | | | | | | | | | | | | |
| 4: | 10.5 | ↗ | | | | | | | | | | | | | | | | | | | | | | | | | | | | | | | | | |
| 5: | 9.5 | ↖ | | | | | | | | | | | | | | | | | | | | | | | | | | | | | | | | | |
| 6: | 9.7 | ← | | | | | | | | | | | | | | | | | | | | | | | | | | | | | | | | | |
| 7: | 9.7 | ↘ | | | | | | | | | | | | | | | | | | | | | | | | | | | | | | | | | |
| 8: | 9.8 | ← | | | | | | | | | | | | | | | | | | | | | | | | | | | | | | | | | |
| 9: | 9.8 | ↘ | | | | | | | | | | | | | | | | | | | | | | | | | | | | | | | | | |
| 10: | 9.6 | ↖ | | | | | | | | | | | | | | | | | | | | | | | | | | | | | | | | | |
| Serie | 94.0 | | | | | | | | | | | | | | | | | | | | | | | | | | | | | | | | | | |
| Total | 94.0 | | | | | | | | | | | | | | | | | | | | | | | | | | | | | | | | | | |

| | | | | | | | | | | | | | | | | | | | | | | | | | | | | | | | | | | | |
|-----------------------|---|-----|-------|---|-----|------|---|-----|------|---|-----|------|---|-----|------|---|-----|-----|---|-----|-------|---|-----|-------|---|-----|-----|---|-----|-----|---|-------|------|-------|-------|
| <p>20 Skud</p> | <table style="width:100%; border-collapse: collapse;"> <tr><td style="text-align: right;">11:</td><td style="text-align: right;">*10.7</td><td style="text-align: right;">↓</td></tr> <tr><td style="text-align: right;">12:</td><td style="text-align: right;">10.3</td><td style="text-align: right;">↗</td></tr> <tr><td style="text-align: right;">13:</td><td style="text-align: right;">10.3</td><td style="text-align: right;">↘</td></tr> <tr><td style="text-align: right;">14:</td><td style="text-align: right;">10.3</td><td style="text-align: right;">←</td></tr> <tr><td style="text-align: right;">15:</td><td style="text-align: right;">10.0</td><td style="text-align: right;">←</td></tr> <tr><td style="text-align: right;">16:</td><td style="text-align: right;">9.9</td><td style="text-align: right;">→</td></tr> <tr><td style="text-align: right;">17:</td><td style="text-align: right;">*10.7</td><td style="text-align: right;">↘</td></tr> <tr><td style="text-align: right;">18:</td><td style="text-align: right;">*10.8</td><td style="text-align: right;">↘</td></tr> <tr><td style="text-align: right;">19:</td><td style="text-align: right;">9.9</td><td style="text-align: right;">↘</td></tr> <tr><td style="text-align: right;">20:</td><td style="text-align: right;">9.6</td><td style="text-align: right;">↖</td></tr> </table> <table border="1" style="width:100%; border-collapse: collapse; margin-top: 5px;"> <tr> <td style="width:80%;">Serie</td> <td style="text-align: right;">97.0</td> </tr> <tr> <td>Total</td> <td style="text-align: right;">191.0</td> </tr> </table> | 11: | *10.7 | ↓ | 12: | 10.3 | ↗ | 13: | 10.3 | ↘ | 14: | 10.3 | ← | 15: | 10.0 | ← | 16: | 9.9 | → | 17: | *10.7 | ↘ | 18: | *10.8 | ↘ | 19: | 9.9 | ↘ | 20: | 9.6 | ↖ | Serie | 97.0 | Total | 191.0 |
| 11: | *10.7 | ↓ | | | | | | | | | | | | | | | | | | | | | | | | | | | | | | | | | |
| 12: | 10.3 | ↗ | | | | | | | | | | | | | | | | | | | | | | | | | | | | | | | | | |
| 13: | 10.3 | ↘ | | | | | | | | | | | | | | | | | | | | | | | | | | | | | | | | | |
| 14: | 10.3 | ← | | | | | | | | | | | | | | | | | | | | | | | | | | | | | | | | | |
| 15: | 10.0 | ← | | | | | | | | | | | | | | | | | | | | | | | | | | | | | | | | | |
| 16: | 9.9 | → | | | | | | | | | | | | | | | | | | | | | | | | | | | | | | | | | |
| 17: | *10.7 | ↘ | | | | | | | | | | | | | | | | | | | | | | | | | | | | | | | | | |
| 18: | *10.8 | ↘ | | | | | | | | | | | | | | | | | | | | | | | | | | | | | | | | | |
| 19: | 9.9 | ↘ | | | | | | | | | | | | | | | | | | | | | | | | | | | | | | | | | |
| 20: | 9.6 | ↖ | | | | | | | | | | | | | | | | | | | | | | | | | | | | | | | | | |
| Serie | 97.0 | | | | | | | | | | | | | | | | | | | | | | | | | | | | | | | | | | |
| Total | 191.0 | | | | | | | | | | | | | | | | | | | | | | | | | | | | | | | | | | |

| | | | | | | | | | | | | | | | | | | | | | | |
|---|---|-------|-----|------|-------|------|-----|----|-------|---|----|------|---|----|------|---|----|------|---|----|-------|---|
| <p>Prøve</p> | <table style="width:100%; border-collapse: collapse;"> <tr><td style="width:10%;">1:</td><td style="width:20%;">9.9</td><td style="width:10%; text-align: center;">↓</td></tr> <tr><td>2:</td><td>10.2</td><td style="text-align: center;">↗</td></tr> <tr><td>3:</td><td>*10.8</td><td style="text-align: center;">↖</td></tr> <tr><td>4:</td><td>10.3</td><td style="text-align: center;">←</td></tr> <tr><td>5:</td><td>10.1</td><td style="text-align: center;">↙</td></tr> <tr><td>6:</td><td>10.4</td><td style="text-align: center;">←</td></tr> <tr><td>7:</td><td>*10.6</td><td style="text-align: center;">↘</td></tr> </table> | 1: | 9.9 | ↓ | 2: | 10.2 | ↗ | 3: | *10.8 | ↖ | 4: | 10.3 | ← | 5: | 10.1 | ↙ | 6: | 10.4 | ← | 7: | *10.6 | ↘ |
| 1: | 9.9 | ↓ | | | | | | | | | | | | | | | | | | | | |
| 2: | 10.2 | ↗ | | | | | | | | | | | | | | | | | | | | |
| 3: | *10.8 | ↖ | | | | | | | | | | | | | | | | | | | | |
| 4: | 10.3 | ← | | | | | | | | | | | | | | | | | | | | |
| 5: | 10.1 | ↙ | | | | | | | | | | | | | | | | | | | | |
| 6: | 10.4 | ← | | | | | | | | | | | | | | | | | | | | |
| 7: | *10.6 | ↘ | | | | | | | | | | | | | | | | | | | | |
| <table style="width:100%; border-collapse: collapse;"> <tr> <td style="width:10%; text-align: right;">Serie</td> <td style="width:80%;"></td> <td style="width:10%; text-align: right;">69.0</td> </tr> <tr> <td style="text-align: right;">Total</td> <td></td> <td style="text-align: right;">0.0</td> </tr> </table> | | Serie | | 69.0 | Total | | 0.0 | | | | | | | | | | | | | | | |
| Serie | | 69.0 | | | | | | | | | | | | | | | | | | | | |
| Total | | 0.0 | | | | | | | | | | | | | | | | | | | | |

| | | | | | | | | | | | | | | | | | | | | | | | | | | | | | | | |
|--|--|-------|-------|------|-------|------|------|----|-------|---|----|-----|---|----|------|---|----|------|---|----|------|---|----|-------|---|----|-------|---|-----|------|---|
| <p>20 Skud</p> | <table style="width:100%; border-collapse: collapse;"> <tr><td style="width:10%;">1:</td><td style="width:20%;">*10.7</td><td style="width:10%; text-align: center;">↗</td></tr> <tr><td>2:</td><td>10.1</td><td style="text-align: center;">↓</td></tr> <tr><td>3:</td><td>*10.9</td><td style="text-align: center;">←</td></tr> <tr><td>4:</td><td>9.7</td><td style="text-align: center;">↗</td></tr> <tr><td>5:</td><td>10.5</td><td style="text-align: center;">↘</td></tr> <tr><td>6:</td><td>10.5</td><td style="text-align: center;">←</td></tr> <tr><td>7:</td><td>10.3</td><td style="text-align: center;">↗</td></tr> <tr><td>8:</td><td>*10.8</td><td style="text-align: center;">↗</td></tr> <tr><td>9:</td><td>*10.7</td><td style="text-align: center;">↓</td></tr> <tr><td>10:</td><td>10.5</td><td style="text-align: center;">↑</td></tr> </table> | 1: | *10.7 | ↗ | 2: | 10.1 | ↓ | 3: | *10.9 | ← | 4: | 9.7 | ↗ | 5: | 10.5 | ↘ | 6: | 10.5 | ← | 7: | 10.3 | ↗ | 8: | *10.8 | ↗ | 9: | *10.7 | ↓ | 10: | 10.5 | ↑ |
| 1: | *10.7 | ↗ | | | | | | | | | | | | | | | | | | | | | | | | | | | | | |
| 2: | 10.1 | ↓ | | | | | | | | | | | | | | | | | | | | | | | | | | | | | |
| 3: | *10.9 | ← | | | | | | | | | | | | | | | | | | | | | | | | | | | | | |
| 4: | 9.7 | ↗ | | | | | | | | | | | | | | | | | | | | | | | | | | | | | |
| 5: | 10.5 | ↘ | | | | | | | | | | | | | | | | | | | | | | | | | | | | | |
| 6: | 10.5 | ← | | | | | | | | | | | | | | | | | | | | | | | | | | | | | |
| 7: | 10.3 | ↗ | | | | | | | | | | | | | | | | | | | | | | | | | | | | | |
| 8: | *10.8 | ↗ | | | | | | | | | | | | | | | | | | | | | | | | | | | | | |
| 9: | *10.7 | ↓ | | | | | | | | | | | | | | | | | | | | | | | | | | | | | |
| 10: | 10.5 | ↑ | | | | | | | | | | | | | | | | | | | | | | | | | | | | | |
| <table style="width:100%; border-collapse: collapse;"> <tr> <td style="width:10%; text-align: right;">Serie</td> <td style="width:80%;"></td> <td style="width:10%; text-align: right;">99.0</td> </tr> <tr> <td style="text-align: right;">Total</td> <td></td> <td style="text-align: right;">99.0</td> </tr> </table> | | Serie | | 99.0 | Total | | 99.0 | | | | | | | | | | | | | | | | | | | | | | | | |
| Serie | | 99.0 | | | | | | | | | | | | | | | | | | | | | | | | | | | | | |
| Total | | 99.0 | | | | | | | | | | | | | | | | | | | | | | | | | | | | | |

| | | | | | | | | | | | | | | | | | | | | | | | | | | | | | | | |
|---|---|-------|------|------|-------|------|-------|-----|-----|---|-----|------|---|-----|------|---|-----|-------|---|-----|------|---|-----|-------|---|-----|-------|---|-----|-------|---|
| <p>20 Skud</p> | <table style="width:100%; border-collapse: collapse;"> <tr><td style="width:10%;">11:</td><td style="width:20%;">10.4</td><td style="width:10%; text-align: center;">↗</td></tr> <tr><td>12:</td><td>10.6</td><td style="text-align: center;">↓</td></tr> <tr><td>13:</td><td>9.9</td><td style="text-align: center;">↑</td></tr> <tr><td>14:</td><td>10.5</td><td style="text-align: center;">↑</td></tr> <tr><td>15:</td><td>10.4</td><td style="text-align: center;">↗</td></tr> <tr><td>16:</td><td>*10.7</td><td style="text-align: center;">↘</td></tr> <tr><td>17:</td><td>10.4</td><td style="text-align: center;">↙</td></tr> <tr><td>18:</td><td>*10.6</td><td style="text-align: center;">↙</td></tr> <tr><td>19:</td><td>*10.7</td><td style="text-align: center;">↗</td></tr> <tr><td>20:</td><td>*10.9</td><td style="text-align: center;">→</td></tr> </table> | 11: | 10.4 | ↗ | 12: | 10.6 | ↓ | 13: | 9.9 | ↑ | 14: | 10.5 | ↑ | 15: | 10.4 | ↗ | 16: | *10.7 | ↘ | 17: | 10.4 | ↙ | 18: | *10.6 | ↙ | 19: | *10.7 | ↗ | 20: | *10.9 | → |
| 11: | 10.4 | ↗ | | | | | | | | | | | | | | | | | | | | | | | | | | | | | |
| 12: | 10.6 | ↓ | | | | | | | | | | | | | | | | | | | | | | | | | | | | | |
| 13: | 9.9 | ↑ | | | | | | | | | | | | | | | | | | | | | | | | | | | | | |
| 14: | 10.5 | ↑ | | | | | | | | | | | | | | | | | | | | | | | | | | | | | |
| 15: | 10.4 | ↗ | | | | | | | | | | | | | | | | | | | | | | | | | | | | | |
| 16: | *10.7 | ↘ | | | | | | | | | | | | | | | | | | | | | | | | | | | | | |
| 17: | 10.4 | ↙ | | | | | | | | | | | | | | | | | | | | | | | | | | | | | |
| 18: | *10.6 | ↙ | | | | | | | | | | | | | | | | | | | | | | | | | | | | | |
| 19: | *10.7 | ↗ | | | | | | | | | | | | | | | | | | | | | | | | | | | | | |
| 20: | *10.9 | → | | | | | | | | | | | | | | | | | | | | | | | | | | | | | |
| <table style="width:100%; border-collapse: collapse;"> <tr> <td style="width:10%; text-align: right;">Serie</td> <td style="width:80%;"></td> <td style="width:10%; text-align: right;">99.0</td> </tr> <tr> <td style="text-align: right;">Total</td> <td></td> <td style="text-align: right;">198.0</td> </tr> </table> | | Serie | | 99.0 | Total | | 198.0 | | | | | | | | | | | | | | | | | | | | | | | | |
| Serie | | 99.0 | | | | | | | | | | | | | | | | | | | | | | | | | | | | | |
| Total | | 198.0 | | | | | | | | | | | | | | | | | | | | | | | | | | | | | |

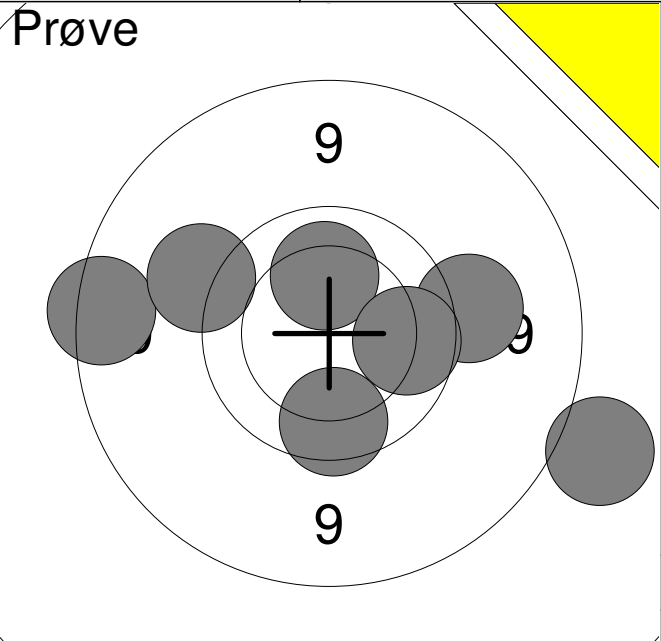
| | | | | | | | | | | | | | | | | | | | | | | | | | | |
|--|--|----|-----|---|----|-----|---|----|-----|---|----|------|---|----|-----|---|----|-----|---|----|-----|---|-------|------|-------|-----|
| <p>Prøve</p>  | <table style="width:100%; border-collapse: collapse;"> <tr><td>1:</td><td style="text-align: center;">8.8</td><td style="text-align: right;">←</td></tr> <tr><td>2:</td><td style="text-align: center;">9.4</td><td style="text-align: right;">→</td></tr> <tr><td>3:</td><td style="text-align: center;">8.5</td><td style="text-align: right;">↘</td></tr> <tr><td>4:</td><td style="text-align: center;">10.2</td><td style="text-align: right;">↑</td></tr> <tr><td>5:</td><td style="text-align: center;">9.9</td><td style="text-align: right;">→</td></tr> <tr><td>6:</td><td style="text-align: center;">9.4</td><td style="text-align: right;">↗</td></tr> <tr><td>7:</td><td style="text-align: center;">9.8</td><td style="text-align: right;">↓</td></tr> </table> <table border="1" style="width:100%; border-collapse: collapse; margin-top: 5px;"> <tr> <td style="width:80%;">Serie</td> <td style="text-align: right;">62.0</td> </tr> <tr> <td>Total</td> <td style="text-align: right;">0.0</td> </tr> </table> | 1: | 8.8 | ← | 2: | 9.4 | → | 3: | 8.5 | ↘ | 4: | 10.2 | ↑ | 5: | 9.9 | → | 6: | 9.4 | ↗ | 7: | 9.8 | ↓ | Serie | 62.0 | Total | 0.0 |
| 1: | 8.8 | ← | | | | | | | | | | | | | | | | | | | | | | | | |
| 2: | 9.4 | → | | | | | | | | | | | | | | | | | | | | | | | | |
| 3: | 8.5 | ↘ | | | | | | | | | | | | | | | | | | | | | | | | |
| 4: | 10.2 | ↑ | | | | | | | | | | | | | | | | | | | | | | | | |
| 5: | 9.9 | → | | | | | | | | | | | | | | | | | | | | | | | | |
| 6: | 9.4 | ↗ | | | | | | | | | | | | | | | | | | | | | | | | |
| 7: | 9.8 | ↓ | | | | | | | | | | | | | | | | | | | | | | | | |
| Serie | 62.0 | | | | | | | | | | | | | | | | | | | | | | | | | |
| Total | 0.0 | | | | | | | | | | | | | | | | | | | | | | | | | |

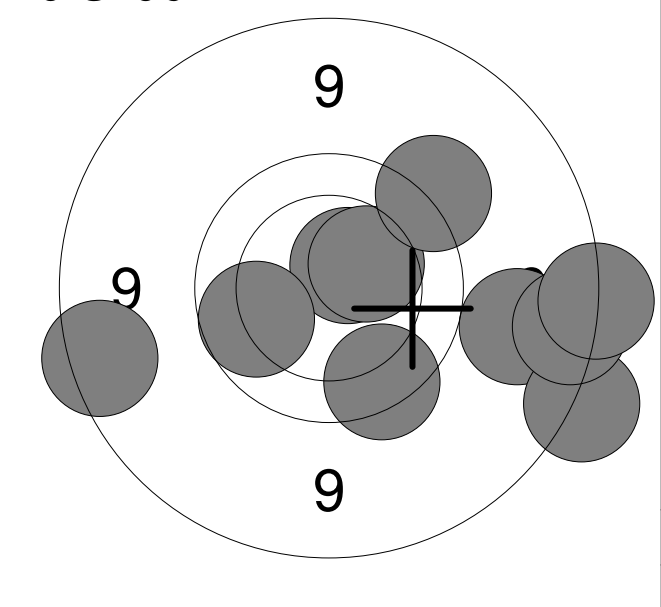
| | | | | | | | | | | | | | | | | | | | | | | | | | | | | | | | | | | | |
|---|--|----|-----|---|----|-----|---|----|-----|---|----|-----|---|----|-----|---|----|-----|---|----|-------|---|----|------|---|----|-----|---|-----|-----|---|-------|------|-------|------|
| <p>20 Skud</p>  | <table style="width:100%; border-collapse: collapse;"> <tr><td>1:</td><td style="text-align: center;">8.8</td><td style="text-align: right;">←</td></tr> <tr><td>2:</td><td style="text-align: center;">9.1</td><td style="text-align: right;">→</td></tr> <tr><td>3:</td><td style="text-align: center;">8.6</td><td style="text-align: right;">↘</td></tr> <tr><td>4:</td><td style="text-align: center;">8.8</td><td style="text-align: right;">→</td></tr> <tr><td>5:</td><td style="text-align: center;">9.7</td><td style="text-align: right;">↓</td></tr> <tr><td>6:</td><td style="text-align: center;">8.7</td><td style="text-align: right;">→</td></tr> <tr><td>7:</td><td style="text-align: center;">*10.6</td><td style="text-align: right;">↗</td></tr> <tr><td>8:</td><td style="text-align: center;">10.4</td><td style="text-align: right;">↗</td></tr> <tr><td>9:</td><td style="text-align: center;">9.5</td><td style="text-align: right;">↗</td></tr> <tr><td>10:</td><td style="text-align: center;">9.9</td><td style="text-align: right;">←</td></tr> </table> <table border="1" style="width:100%; border-collapse: collapse; margin-top: 5px;"> <tr> <td style="width:80%;">Serie</td> <td style="text-align: right;">88.0</td> </tr> <tr> <td>Total</td> <td style="text-align: right;">88.0</td> </tr> </table> | 1: | 8.8 | ← | 2: | 9.1 | → | 3: | 8.6 | ↘ | 4: | 8.8 | → | 5: | 9.7 | ↓ | 6: | 8.7 | → | 7: | *10.6 | ↗ | 8: | 10.4 | ↗ | 9: | 9.5 | ↗ | 10: | 9.9 | ← | Serie | 88.0 | Total | 88.0 |
| 1: | 8.8 | ← | | | | | | | | | | | | | | | | | | | | | | | | | | | | | | | | | |
| 2: | 9.1 | → | | | | | | | | | | | | | | | | | | | | | | | | | | | | | | | | | |
| 3: | 8.6 | ↘ | | | | | | | | | | | | | | | | | | | | | | | | | | | | | | | | | |
| 4: | 8.8 | → | | | | | | | | | | | | | | | | | | | | | | | | | | | | | | | | | |
| 5: | 9.7 | ↓ | | | | | | | | | | | | | | | | | | | | | | | | | | | | | | | | | |
| 6: | 8.7 | → | | | | | | | | | | | | | | | | | | | | | | | | | | | | | | | | | |
| 7: | *10.6 | ↗ | | | | | | | | | | | | | | | | | | | | | | | | | | | | | | | | | |
| 8: | 10.4 | ↗ | | | | | | | | | | | | | | | | | | | | | | | | | | | | | | | | | |
| 9: | 9.5 | ↗ | | | | | | | | | | | | | | | | | | | | | | | | | | | | | | | | | |
| 10: | 9.9 | ← | | | | | | | | | | | | | | | | | | | | | | | | | | | | | | | | | |
| Serie | 88.0 | | | | | | | | | | | | | | | | | | | | | | | | | | | | | | | | | | |
| Total | 88.0 | | | | | | | | | | | | | | | | | | | | | | | | | | | | | | | | | | |

| | | | | | | | | | | | | | | | | | | | | | | | | | | | | | | | | | | | |
|--|--|-----|-----|---|-----|-------|---|-----|------|---|-----|-----|---|-----|-----|---|-----|-----|---|-----|-------|---|-----|-----|---|-----|-----|---|-----|-----|---|-------|------|-------|-------|
| <p>20 Skud</p>  | <table style="width:100%; border-collapse: collapse;"> <tr><td>11:</td><td style="text-align: center;">9.9</td><td style="text-align: right;">↘</td></tr> <tr><td>12:</td><td style="text-align: center;">*10.5</td><td style="text-align: right;">→</td></tr> <tr><td>13:</td><td style="text-align: center;">10.4</td><td style="text-align: right;">↘</td></tr> <tr><td>14:</td><td style="text-align: center;">9.6</td><td style="text-align: right;">↑</td></tr> <tr><td>15:</td><td style="text-align: center;">8.9</td><td style="text-align: right;">↘</td></tr> <tr><td>16:</td><td style="text-align: center;">9.6</td><td style="text-align: right;">↗</td></tr> <tr><td>17:</td><td style="text-align: center;">*10.6</td><td style="text-align: right;">↘</td></tr> <tr><td>18:</td><td style="text-align: center;">9.6</td><td style="text-align: right;">↗</td></tr> <tr><td>19:</td><td style="text-align: center;">8.9</td><td style="text-align: right;">↓</td></tr> <tr><td>20:</td><td style="text-align: center;">9.4</td><td style="text-align: right;">↑</td></tr> </table> <table border="1" style="width:100%; border-collapse: collapse; margin-top: 5px;"> <tr> <td style="width:80%;">Serie</td> <td style="text-align: right;">91.0</td> </tr> <tr> <td>Total</td> <td style="text-align: right;">179.0</td> </tr> </table> | 11: | 9.9 | ↘ | 12: | *10.5 | → | 13: | 10.4 | ↘ | 14: | 9.6 | ↑ | 15: | 8.9 | ↘ | 16: | 9.6 | ↗ | 17: | *10.6 | ↘ | 18: | 9.6 | ↗ | 19: | 8.9 | ↓ | 20: | 9.4 | ↑ | Serie | 91.0 | Total | 179.0 |
| 11: | 9.9 | ↘ | | | | | | | | | | | | | | | | | | | | | | | | | | | | | | | | | |
| 12: | *10.5 | → | | | | | | | | | | | | | | | | | | | | | | | | | | | | | | | | | |
| 13: | 10.4 | ↘ | | | | | | | | | | | | | | | | | | | | | | | | | | | | | | | | | |
| 14: | 9.6 | ↑ | | | | | | | | | | | | | | | | | | | | | | | | | | | | | | | | | |
| 15: | 8.9 | ↘ | | | | | | | | | | | | | | | | | | | | | | | | | | | | | | | | | |
| 16: | 9.6 | ↗ | | | | | | | | | | | | | | | | | | | | | | | | | | | | | | | | | |
| 17: | *10.6 | ↘ | | | | | | | | | | | | | | | | | | | | | | | | | | | | | | | | | |
| 18: | 9.6 | ↗ | | | | | | | | | | | | | | | | | | | | | | | | | | | | | | | | | |
| 19: | 8.9 | ↓ | | | | | | | | | | | | | | | | | | | | | | | | | | | | | | | | | |
| 20: | 9.4 | ↑ | | | | | | | | | | | | | | | | | | | | | | | | | | | | | | | | | |
| Serie | 91.0 | | | | | | | | | | | | | | | | | | | | | | | | | | | | | | | | | | |
| Total | 179.0 | | | | | | | | | | | | | | | | | | | | | | | | | | | | | | | | | | |

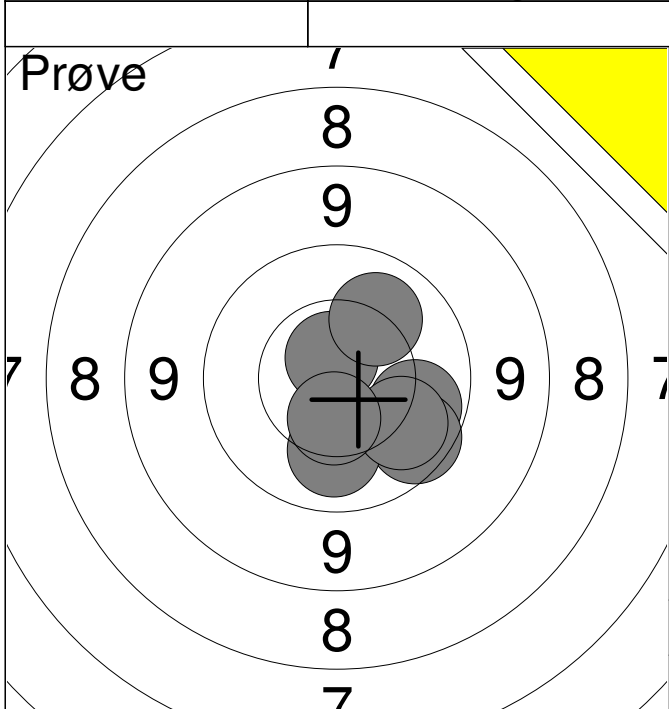

| | | |
|-------|-------|------|
| 1: | 10.0 | → |
| 2: | 9.8 | ↘ |
| 3: | *10.7 | ↗ |
| 4: | 10.1 | ↘ |
| 5: | 10.1 | ↗ |
| 6: | 10.0 | ↘ |
| 7: | 10.5 | ↘ |
| Serie | | 69.0 |
| Total | | 0.0 |

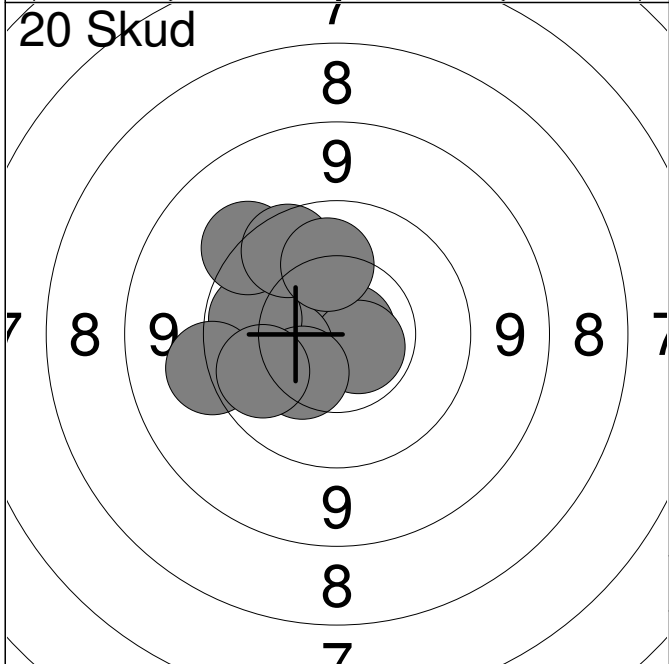

| | | |
|-------|-------|------|
| 1: | *10.8 | → |
| 2: | *10.7 | ↘ |
| 3: | 10.3 | ← |
| 4: | 10.0 | ← |
| 5: | 9.4 | ← |
| 6: | 9.5 | ↗ |
| 7: | 10.4 | ↘ |
| 8: | 9.8 | ↗ |
| 9: | 10.0 | ← |
| 10: | 10.1 | ↑ |
| Serie | | 97.0 |
| Total | | 97.0 |

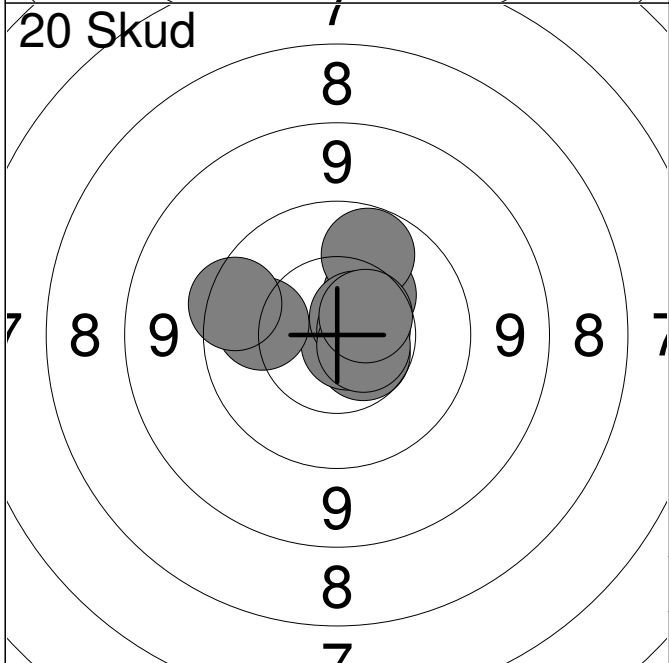

| | | |
|-------|-------|-------|
| 11: | 10.4 | ↗ |
| 12: | 10.6 | ↘ |
| 13: | 10.0 | ↗ |
| 14: | *10.8 | ↘ |
| 15: | 10.1 | ← |
| 16: | *10.6 | ↗ |
| 17: | *10.6 | → |
| 18: | 9.7 | ← |
| 19: | *10.6 | ↘ |
| 20: | 10.5 | ↗ |
| Serie | | 99.0 |
| Total | | 196.0 |

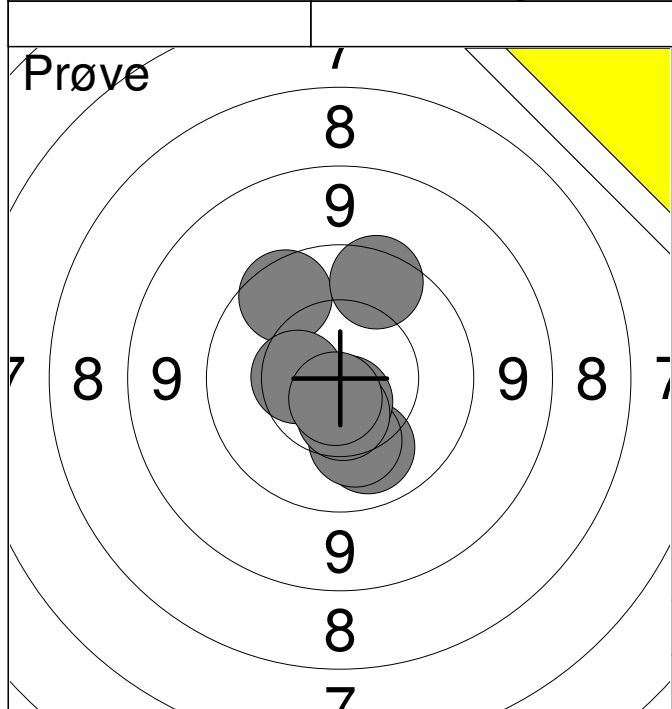

| | | |
|-------|-------|------|
| 1: | 10.1 | ↓ |
| 2: | 10.2 | ↓ |
| 3: | *10.7 | ↓ |
| 4: | 9.8 | ↑ |
| 5: | 10.5 | ↓ |
| 6: | 10.5 | ← |
| 7: | 9.7 | ↑ |
| 8: | *10.7 | ↓ |
| Serie | | 78.0 |
| Total | | 0.0 |

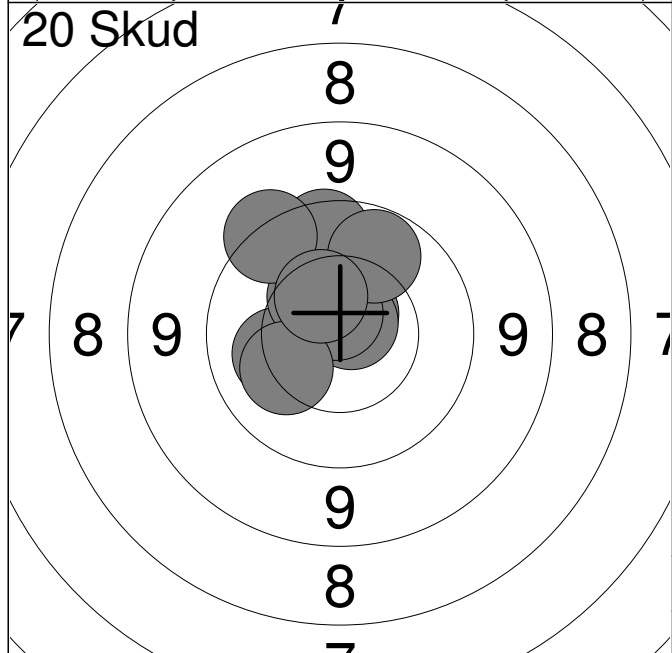

| | | |
|-------|-------|------|
| 1: | *10.7 | ↑ |
| 2: | *10.8 | ↑ |
| 3: | *10.7 | ↑ |
| 4: | 10.2 | ← |
| 5: | 9.8 | ↑ |
| 6: | 10.0 | ↑ |
| 7: | 10.4 | ↑ |
| 8: | 9.5 | ↑ |
| 9: | 10.2 | ← |
| 10: | 10.5 | ↑ |
| Serie | | 98.0 |
| Total | | 98.0 |

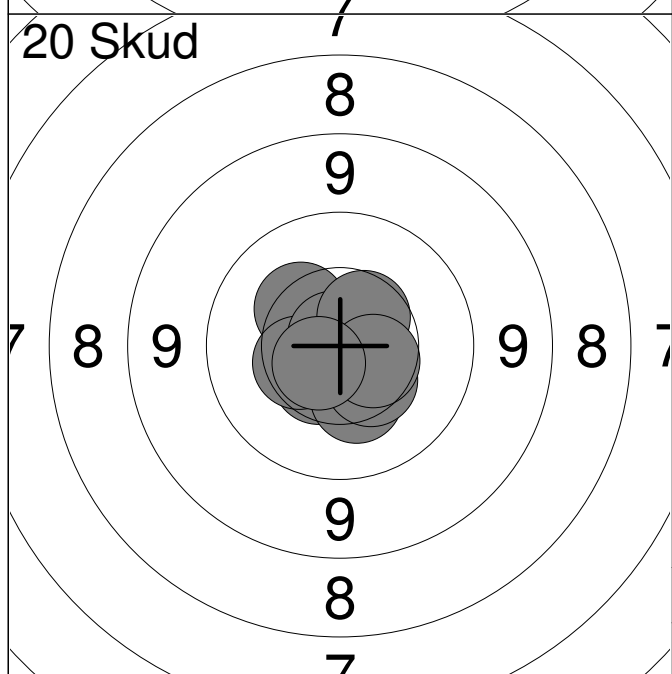

| | | |
|-------|-------|-------|
| 11: | 10.3 | ↑ |
| 12: | 10.5 | ↓ |
| 13: | 10.3 | ↓ |
| 14: | *10.9 | ↑ |
| 15: | 10.4 | ← |
| 16: | 10.4 | ↓ |
| 17: | *10.8 | ↑ |
| 18: | 10.5 | ↑ |
| 19: | 10.5 | ↓ |
| 20: | *10.6 | ← |
| Serie | | 100.0 |
| Total | | 198.0 |

| | | | | | | | | | | | | | | | | | | | | | | | | | | | | | | | | | | | | | |
|---------------------|--|------|-----|---|----|-----|---|----|-------|---|----|-----|---|----|------|---|----|-----|---|----|-----|---|----|-----|---|----|------|---|-----|-----|---|-------|--|------|-------|--|-----|
| <p>Prøve</p> | <table style="width:100%; border-collapse: collapse;"> <tr><td>1:</td><td style="text-align: right;">8.6</td><td style="text-align: right;">↙</td></tr> <tr><td>2:</td><td style="text-align: right;">8.6</td><td style="text-align: right;">←</td></tr> <tr><td>3:</td><td style="text-align: right;">*10.8</td><td style="text-align: right;">↗</td></tr> <tr><td>4:</td><td style="text-align: right;">9.7</td><td style="text-align: right;">↘</td></tr> <tr><td>5:</td><td style="text-align: right;">10.3</td><td style="text-align: right;">→</td></tr> <tr><td>6:</td><td style="text-align: right;">9.4</td><td style="text-align: right;">→</td></tr> <tr><td>7:</td><td style="text-align: right;">9.2</td><td style="text-align: right;">↙</td></tr> <tr><td>8:</td><td style="text-align: right;">9.0</td><td style="text-align: right;">↘</td></tr> <tr><td>9:</td><td style="text-align: right;">10.1</td><td style="text-align: right;">↗</td></tr> <tr><td>10:</td><td style="text-align: right;">9.3</td><td style="text-align: right;">→</td></tr> <tr style="border-top: 1px solid black;"><td colspan="2">Serie</td><td style="text-align: right;">91.0</td></tr> <tr><td colspan="2">Total</td><td style="text-align: right;">0.0</td></tr> </table> | 1: | 8.6 | ↙ | 2: | 8.6 | ← | 3: | *10.8 | ↗ | 4: | 9.7 | ↘ | 5: | 10.3 | → | 6: | 9.4 | → | 7: | 9.2 | ↙ | 8: | 9.0 | ↘ | 9: | 10.1 | ↗ | 10: | 9.3 | → | Serie | | 91.0 | Total | | 0.0 |
| 1: | 8.6 | ↙ | | | | | | | | | | | | | | | | | | | | | | | | | | | | | | | | | | | |
| 2: | 8.6 | ← | | | | | | | | | | | | | | | | | | | | | | | | | | | | | | | | | | | |
| 3: | *10.8 | ↗ | | | | | | | | | | | | | | | | | | | | | | | | | | | | | | | | | | | |
| 4: | 9.7 | ↘ | | | | | | | | | | | | | | | | | | | | | | | | | | | | | | | | | | | |
| 5: | 10.3 | → | | | | | | | | | | | | | | | | | | | | | | | | | | | | | | | | | | | |
| 6: | 9.4 | → | | | | | | | | | | | | | | | | | | | | | | | | | | | | | | | | | | | |
| 7: | 9.2 | ↙ | | | | | | | | | | | | | | | | | | | | | | | | | | | | | | | | | | | |
| 8: | 9.0 | ↘ | | | | | | | | | | | | | | | | | | | | | | | | | | | | | | | | | | | |
| 9: | 10.1 | ↗ | | | | | | | | | | | | | | | | | | | | | | | | | | | | | | | | | | | |
| 10: | 9.3 | → | | | | | | | | | | | | | | | | | | | | | | | | | | | | | | | | | | | |
| Serie | | 91.0 | | | | | | | | | | | | | | | | | | | | | | | | | | | | | | | | | | | |
| Total | | 0.0 | | | | | | | | | | | | | | | | | | | | | | | | | | | | | | | | | | | |

| | | | | | | | | | | | | | | | | | | | | | | | | | | | | | | | | | | | | | |
|-----------------------|---|------|-----|---|----|-----|---|----|-----|---|----|-----|---|----|-----|---|----|-----|---|----|-----|---|----|------|---|----|-----|---|-----|------|---|-------|--|------|-------|--|------|
| <p>20 Skud</p> | <table style="width:100%; border-collapse: collapse;"> <tr><td>1:</td><td style="text-align: right;">9.9</td><td style="text-align: right;">→</td></tr> <tr><td>2:</td><td style="text-align: right;">9.7</td><td style="text-align: right;">↘</td></tr> <tr><td>3:</td><td style="text-align: right;">9.8</td><td style="text-align: right;">↙</td></tr> <tr><td>4:</td><td style="text-align: right;">9.2</td><td style="text-align: right;">↙</td></tr> <tr><td>5:</td><td style="text-align: right;">9.3</td><td style="text-align: right;">↙</td></tr> <tr><td>6:</td><td style="text-align: right;">8.4</td><td style="text-align: right;">→</td></tr> <tr><td>7:</td><td style="text-align: right;">9.2</td><td style="text-align: right;">↗</td></tr> <tr><td>8:</td><td style="text-align: right;">10.1</td><td style="text-align: right;">↘</td></tr> <tr><td>9:</td><td style="text-align: right;">9.9</td><td style="text-align: right;">↗</td></tr> <tr><td>10:</td><td style="text-align: right;">10.2</td><td style="text-align: right;">↘</td></tr> <tr style="border-top: 1px solid black;"><td colspan="2">Serie</td><td style="text-align: right;">91.0</td></tr> <tr><td colspan="2">Total</td><td style="text-align: right;">91.0</td></tr> </table> | 1: | 9.9 | → | 2: | 9.7 | ↘ | 3: | 9.8 | ↙ | 4: | 9.2 | ↙ | 5: | 9.3 | ↙ | 6: | 8.4 | → | 7: | 9.2 | ↗ | 8: | 10.1 | ↘ | 9: | 9.9 | ↗ | 10: | 10.2 | ↘ | Serie | | 91.0 | Total | | 91.0 |
| 1: | 9.9 | → | | | | | | | | | | | | | | | | | | | | | | | | | | | | | | | | | | | |
| 2: | 9.7 | ↘ | | | | | | | | | | | | | | | | | | | | | | | | | | | | | | | | | | | |
| 3: | 9.8 | ↙ | | | | | | | | | | | | | | | | | | | | | | | | | | | | | | | | | | | |
| 4: | 9.2 | ↙ | | | | | | | | | | | | | | | | | | | | | | | | | | | | | | | | | | | |
| 5: | 9.3 | ↙ | | | | | | | | | | | | | | | | | | | | | | | | | | | | | | | | | | | |
| 6: | 8.4 | → | | | | | | | | | | | | | | | | | | | | | | | | | | | | | | | | | | | |
| 7: | 9.2 | ↗ | | | | | | | | | | | | | | | | | | | | | | | | | | | | | | | | | | | |
| 8: | 10.1 | ↘ | | | | | | | | | | | | | | | | | | | | | | | | | | | | | | | | | | | |
| 9: | 9.9 | ↗ | | | | | | | | | | | | | | | | | | | | | | | | | | | | | | | | | | | |
| 10: | 10.2 | ↘ | | | | | | | | | | | | | | | | | | | | | | | | | | | | | | | | | | | |
| Serie | | 91.0 | | | | | | | | | | | | | | | | | | | | | | | | | | | | | | | | | | | |
| Total | | 91.0 | | | | | | | | | | | | | | | | | | | | | | | | | | | | | | | | | | | |

| | | | | | | | | | | | | | | | | | | | | | | | | | | | | | | | | | | | | | |
|-----------------------|---|-------|-----|---|-----|-----|---|-----|------|---|-----|-----|---|-----|------|---|-----|-----|---|-----|-----|---|-----|-----|---|-----|-----|---|-----|-----|---|-------|--|------|-------|--|-------|
| <p>20 Skud</p> | <table style="width:100%; border-collapse: collapse;"> <tr><td>11:</td><td style="text-align: right;">9.4</td><td style="text-align: right;">↘</td></tr> <tr><td>12:</td><td style="text-align: right;">9.9</td><td style="text-align: right;">←</td></tr> <tr><td>13:</td><td style="text-align: right;">10.3</td><td style="text-align: right;">↘</td></tr> <tr><td>14:</td><td style="text-align: right;">9.3</td><td style="text-align: right;">↗</td></tr> <tr><td>15:</td><td style="text-align: right;">10.3</td><td style="text-align: right;">↘</td></tr> <tr><td>16:</td><td style="text-align: right;">8.8</td><td style="text-align: right;">→</td></tr> <tr><td>17:</td><td style="text-align: right;">9.4</td><td style="text-align: right;">↘</td></tr> <tr><td>18:</td><td style="text-align: right;">9.2</td><td style="text-align: right;">↗</td></tr> <tr><td>19:</td><td style="text-align: right;">9.7</td><td style="text-align: right;">↘</td></tr> <tr><td>20:</td><td style="text-align: right;">8.7</td><td style="text-align: right;">↙</td></tr> <tr style="border-top: 1px solid black;"><td colspan="2">Serie</td><td style="text-align: right;">90.0</td></tr> <tr><td colspan="2">Total</td><td style="text-align: right;">181.0</td></tr> </table> | 11: | 9.4 | ↘ | 12: | 9.9 | ← | 13: | 10.3 | ↘ | 14: | 9.3 | ↗ | 15: | 10.3 | ↘ | 16: | 8.8 | → | 17: | 9.4 | ↘ | 18: | 9.2 | ↗ | 19: | 9.7 | ↘ | 20: | 8.7 | ↙ | Serie | | 90.0 | Total | | 181.0 |
| 11: | 9.4 | ↘ | | | | | | | | | | | | | | | | | | | | | | | | | | | | | | | | | | | |
| 12: | 9.9 | ← | | | | | | | | | | | | | | | | | | | | | | | | | | | | | | | | | | | |
| 13: | 10.3 | ↘ | | | | | | | | | | | | | | | | | | | | | | | | | | | | | | | | | | | |
| 14: | 9.3 | ↗ | | | | | | | | | | | | | | | | | | | | | | | | | | | | | | | | | | | |
| 15: | 10.3 | ↘ | | | | | | | | | | | | | | | | | | | | | | | | | | | | | | | | | | | |
| 16: | 8.8 | → | | | | | | | | | | | | | | | | | | | | | | | | | | | | | | | | | | | |
| 17: | 9.4 | ↘ | | | | | | | | | | | | | | | | | | | | | | | | | | | | | | | | | | | |
| 18: | 9.2 | ↗ | | | | | | | | | | | | | | | | | | | | | | | | | | | | | | | | | | | |
| 19: | 9.7 | ↘ | | | | | | | | | | | | | | | | | | | | | | | | | | | | | | | | | | | |
| 20: | 8.7 | ↙ | | | | | | | | | | | | | | | | | | | | | | | | | | | | | | | | | | | |
| Serie | | 90.0 | | | | | | | | | | | | | | | | | | | | | | | | | | | | | | | | | | | |
| Total | | 181.0 | | | | | | | | | | | | | | | | | | | | | | | | | | | | | | | | | | | |

| | | | | | | | | | | | | | | | | | | | | | | | | | | | | | | | | | | | | | |
|-----------------------|---|--------------|-------|---|-----|-------|---|-----|-------|---|-----|------|---|-----|-------|---|-----|-------|---|--------------|-------|-------------|--------------|-------|------------|-----|-------|---|-----|------|---|--------------|--|--------------|--------------|--|--------------|
| <p>Prøve</p> | <table style="width:100%; border-collapse: collapse;"> <tr><td style="width:10%;">1:</td><td style="width:20%;">9.7</td><td style="width:10%; text-align: right;">↓</td></tr> <tr><td>2:</td><td>9.7</td><td style="text-align: right;">↓</td></tr> <tr><td>3:</td><td>*10.7</td><td style="text-align: right;">↙</td></tr> <tr><td>4:</td><td>10.0</td><td style="text-align: right;">↓</td></tr> <tr><td>5:</td><td>*10.6</td><td style="text-align: right;">→</td></tr> <tr><td>6:</td><td>10.2</td><td style="text-align: right;">→</td></tr> <tr><td colspan="2">Serie</td><td style="text-align: right;">58.0</td></tr> <tr><td colspan="2">Total</td><td style="text-align: right;">0.0</td></tr> </table> | 1: | 9.7 | ↓ | 2: | 9.7 | ↓ | 3: | *10.7 | ↙ | 4: | 10.0 | ↓ | 5: | *10.6 | → | 6: | 10.2 | → | Serie | | 58.0 | Total | | 0.0 | | | | | | | | | | | | |
| 1: | 9.7 | ↓ | | | | | | | | | | | | | | | | | | | | | | | | | | | | | | | | | | | |
| 2: | 9.7 | ↓ | | | | | | | | | | | | | | | | | | | | | | | | | | | | | | | | | | | |
| 3: | *10.7 | ↙ | | | | | | | | | | | | | | | | | | | | | | | | | | | | | | | | | | | |
| 4: | 10.0 | ↓ | | | | | | | | | | | | | | | | | | | | | | | | | | | | | | | | | | | |
| 5: | *10.6 | → | | | | | | | | | | | | | | | | | | | | | | | | | | | | | | | | | | | |
| 6: | 10.2 | → | | | | | | | | | | | | | | | | | | | | | | | | | | | | | | | | | | | |
| Serie | | 58.0 | | | | | | | | | | | | | | | | | | | | | | | | | | | | | | | | | | | |
| Total | | 0.0 | | | | | | | | | | | | | | | | | | | | | | | | | | | | | | | | | | | |
| <p>20 Skud</p> | <table style="width:100%; border-collapse: collapse;"> <tr><td style="width:10%;">1:</td><td style="width:20%;">*10.6</td><td style="width:10%; text-align: right;">→</td></tr> <tr><td>2:</td><td>*10.7</td><td style="text-align: right;">↙</td></tr> <tr><td>3:</td><td>*10.8</td><td style="text-align: right;">↙</td></tr> <tr><td>4:</td><td>10.5</td><td style="text-align: right;">→</td></tr> <tr><td>5:</td><td>*10.6</td><td style="text-align: right;">↙</td></tr> <tr><td>6:</td><td>10.4</td><td style="text-align: right;">→</td></tr> <tr><td>7:</td><td>*10.7</td><td style="text-align: right;">↗</td></tr> <tr><td>8:</td><td>*10.6</td><td style="text-align: right;">↗</td></tr> <tr><td>9:</td><td>10.3</td><td style="text-align: right;">→</td></tr> <tr><td>10:</td><td>10.4</td><td style="text-align: right;">↙</td></tr> <tr><td colspan="2">Serie</td><td style="text-align: right;">100.0</td></tr> <tr><td colspan="2">Total</td><td style="text-align: right;">100.0</td></tr> </table> | 1: | *10.6 | → | 2: | *10.7 | ↙ | 3: | *10.8 | ↙ | 4: | 10.5 | → | 5: | *10.6 | ↙ | 6: | 10.4 | → | 7: | *10.7 | ↗ | 8: | *10.6 | ↗ | 9: | 10.3 | → | 10: | 10.4 | ↙ | Serie | | 100.0 | Total | | 100.0 |
| 1: | *10.6 | → | | | | | | | | | | | | | | | | | | | | | | | | | | | | | | | | | | | |
| 2: | *10.7 | ↙ | | | | | | | | | | | | | | | | | | | | | | | | | | | | | | | | | | | |
| 3: | *10.8 | ↙ | | | | | | | | | | | | | | | | | | | | | | | | | | | | | | | | | | | |
| 4: | 10.5 | → | | | | | | | | | | | | | | | | | | | | | | | | | | | | | | | | | | | |
| 5: | *10.6 | ↙ | | | | | | | | | | | | | | | | | | | | | | | | | | | | | | | | | | | |
| 6: | 10.4 | → | | | | | | | | | | | | | | | | | | | | | | | | | | | | | | | | | | | |
| 7: | *10.7 | ↗ | | | | | | | | | | | | | | | | | | | | | | | | | | | | | | | | | | | |
| 8: | *10.6 | ↗ | | | | | | | | | | | | | | | | | | | | | | | | | | | | | | | | | | | |
| 9: | 10.3 | → | | | | | | | | | | | | | | | | | | | | | | | | | | | | | | | | | | | |
| 10: | 10.4 | ↙ | | | | | | | | | | | | | | | | | | | | | | | | | | | | | | | | | | | |
| Serie | | 100.0 | | | | | | | | | | | | | | | | | | | | | | | | | | | | | | | | | | | |
| Total | | 100.0 | | | | | | | | | | | | | | | | | | | | | | | | | | | | | | | | | | | |
| <p>20 Skud</p> | <table style="width:100%; border-collapse: collapse;"> <tr><td style="width:10%;">11:</td><td style="width:20%;">*10.7</td><td style="width:10%; text-align: right;">↙</td></tr> <tr><td>12:</td><td>10.2</td><td style="text-align: right;">↙</td></tr> <tr><td>13:</td><td>*10.7</td><td style="text-align: right;">↗</td></tr> <tr><td>14:</td><td>10.1</td><td style="text-align: right;">→</td></tr> <tr><td>15:</td><td>*10.8</td><td style="text-align: right;">↑</td></tr> <tr><td>16:</td><td>*10.7</td><td style="text-align: right;">→</td></tr> <tr><td>17:</td><td>*10.7</td><td style="text-align: right;">↙</td></tr> <tr><td>18:</td><td>*10.6</td><td style="text-align: right;">↑</td></tr> <tr><td>19:</td><td>*10.7</td><td style="text-align: right;">↙</td></tr> <tr><td>20:</td><td>10.4</td><td style="text-align: right;">↙</td></tr> <tr><td colspan="2">Serie</td><td style="text-align: right;">100.0</td></tr> <tr><td colspan="2">Total</td><td style="text-align: right;">200.0</td></tr> </table> | 11: | *10.7 | ↙ | 12: | 10.2 | ↙ | 13: | *10.7 | ↗ | 14: | 10.1 | → | 15: | *10.8 | ↑ | 16: | *10.7 | → | 17: | *10.7 | ↙ | 18: | *10.6 | ↑ | 19: | *10.7 | ↙ | 20: | 10.4 | ↙ | Serie | | 100.0 | Total | | 200.0 |
| 11: | *10.7 | ↙ | | | | | | | | | | | | | | | | | | | | | | | | | | | | | | | | | | | |
| 12: | 10.2 | ↙ | | | | | | | | | | | | | | | | | | | | | | | | | | | | | | | | | | | |
| 13: | *10.7 | ↗ | | | | | | | | | | | | | | | | | | | | | | | | | | | | | | | | | | | |
| 14: | 10.1 | → | | | | | | | | | | | | | | | | | | | | | | | | | | | | | | | | | | | |
| 15: | *10.8 | ↑ | | | | | | | | | | | | | | | | | | | | | | | | | | | | | | | | | | | |
| 16: | *10.7 | → | | | | | | | | | | | | | | | | | | | | | | | | | | | | | | | | | | | |
| 17: | *10.7 | ↙ | | | | | | | | | | | | | | | | | | | | | | | | | | | | | | | | | | | |
| 18: | *10.6 | ↑ | | | | | | | | | | | | | | | | | | | | | | | | | | | | | | | | | | | |
| 19: | *10.7 | ↙ | | | | | | | | | | | | | | | | | | | | | | | | | | | | | | | | | | | |
| 20: | 10.4 | ↙ | | | | | | | | | | | | | | | | | | | | | | | | | | | | | | | | | | | |
| Serie | | 100.0 | | | | | | | | | | | | | | | | | | | | | | | | | | | | | | | | | | | |
| Total | | 200.0 | | | | | | | | | | | | | | | | | | | | | | | | | | | | | | | | | | | |

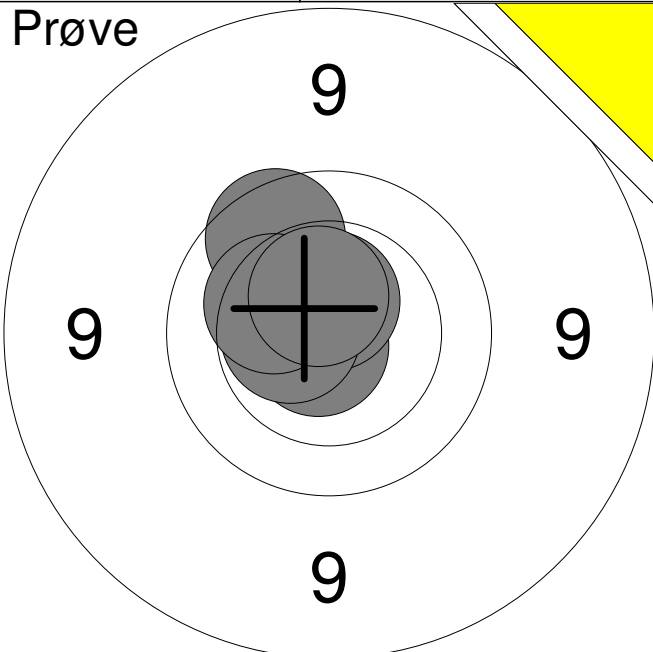
| | | | | | | | | | | | | | | | | | | | | | | | |
|--|--|----|-------|---|----|-------|---|----|-----|---|----|-------|---|----|------|---|----|-------|---|-------|------|-------|-----|
| <p>Prøve</p>  | <table style="width:100%; border-collapse: collapse;"> <tr><td style="width:10%;">1:</td><td style="width:15%;">*10.8</td><td style="width:10%; text-align: center;">↙</td></tr> <tr><td>2:</td><td>*10.6</td><td style="text-align: center;">↑</td></tr> <tr><td>3:</td><td>9.9</td><td style="text-align: center;">↗</td></tr> <tr><td>4:</td><td>*10.5</td><td style="text-align: center;">←</td></tr> <tr><td>5:</td><td>10.3</td><td style="text-align: center;">↖</td></tr> <tr><td>6:</td><td>*10.5</td><td style="text-align: center;">↗</td></tr> </table> <table border="1" style="width:100%; border-collapse: collapse; margin-top: 5px;"> <tr> <td style="width:80%;">Serie</td> <td style="width:20%; text-align: right;">59.0</td> </tr> <tr> <td>Total</td> <td style="text-align: right;">0.0</td> </tr> </table> | 1: | *10.8 | ↙ | 2: | *10.6 | ↑ | 3: | 9.9 | ↗ | 4: | *10.5 | ← | 5: | 10.3 | ↖ | 6: | *10.5 | ↗ | Serie | 59.0 | Total | 0.0 |
| 1: | *10.8 | ↙ | | | | | | | | | | | | | | | | | | | | | |
| 2: | *10.6 | ↑ | | | | | | | | | | | | | | | | | | | | | |
| 3: | 9.9 | ↗ | | | | | | | | | | | | | | | | | | | | | |
| 4: | *10.5 | ← | | | | | | | | | | | | | | | | | | | | | |
| 5: | 10.3 | ↖ | | | | | | | | | | | | | | | | | | | | | |
| 6: | *10.5 | ↗ | | | | | | | | | | | | | | | | | | | | | |
| Serie | 59.0 | | | | | | | | | | | | | | | | | | | | | | |
| Total | 0.0 | | | | | | | | | | | | | | | | | | | | | | |

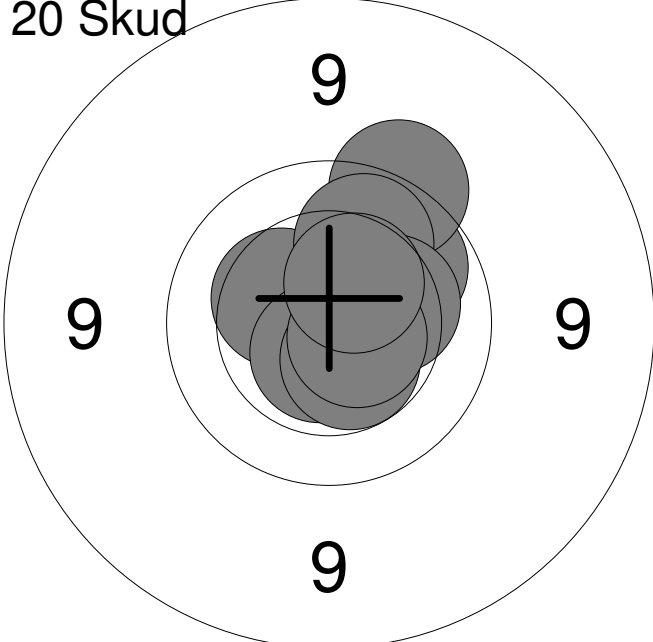
| | | | | | | | | | | | | | | | | | | | | | | | | | | | | | | | | | | | |
|---|--|----|------|---|----|-------|---|----|-----|---|----|------|---|----|------|---|----|------|---|----|-------|---|----|-------|---|----|-------|---|-----|------|---|-------|------|-------|------|
| <p>20 Skud</p>  | <table style="width:100%; border-collapse: collapse;"> <tr><td style="width:10%;">1:</td><td style="width:15%;">10.0</td><td style="width:10%; text-align: center;">↗</td></tr> <tr><td>2:</td><td>*10.7</td><td style="text-align: center;">↗</td></tr> <tr><td>3:</td><td>9.6</td><td style="text-align: center;">↗</td></tr> <tr><td>4:</td><td>10.4</td><td style="text-align: center;">↖</td></tr> <tr><td>5:</td><td>10.0</td><td style="text-align: center;">↗</td></tr> <tr><td>6:</td><td>10.3</td><td style="text-align: center;">→</td></tr> <tr><td>7:</td><td>*10.6</td><td style="text-align: center;">↓</td></tr> <tr><td>8:</td><td>*10.5</td><td style="text-align: center;">↓</td></tr> <tr><td>9:</td><td>*10.6</td><td style="text-align: center;">↘</td></tr> <tr><td>10:</td><td>10.4</td><td style="text-align: center;">↗</td></tr> </table> <table border="1" style="width:100%; border-collapse: collapse; margin-top: 5px;"> <tr> <td style="width:80%;">Serie</td> <td style="width:20%; text-align: right;">99.0</td> </tr> <tr> <td>Total</td> <td style="text-align: right;">99.0</td> </tr> </table> | 1: | 10.0 | ↗ | 2: | *10.7 | ↗ | 3: | 9.6 | ↗ | 4: | 10.4 | ↖ | 5: | 10.0 | ↗ | 6: | 10.3 | → | 7: | *10.6 | ↓ | 8: | *10.5 | ↓ | 9: | *10.6 | ↘ | 10: | 10.4 | ↗ | Serie | 99.0 | Total | 99.0 |
| 1: | 10.0 | ↗ | | | | | | | | | | | | | | | | | | | | | | | | | | | | | | | | | |
| 2: | *10.7 | ↗ | | | | | | | | | | | | | | | | | | | | | | | | | | | | | | | | | |
| 3: | 9.6 | ↗ | | | | | | | | | | | | | | | | | | | | | | | | | | | | | | | | | |
| 4: | 10.4 | ↖ | | | | | | | | | | | | | | | | | | | | | | | | | | | | | | | | | |
| 5: | 10.0 | ↗ | | | | | | | | | | | | | | | | | | | | | | | | | | | | | | | | | |
| 6: | 10.3 | → | | | | | | | | | | | | | | | | | | | | | | | | | | | | | | | | | |
| 7: | *10.6 | ↓ | | | | | | | | | | | | | | | | | | | | | | | | | | | | | | | | | |
| 8: | *10.5 | ↓ | | | | | | | | | | | | | | | | | | | | | | | | | | | | | | | | | |
| 9: | *10.6 | ↘ | | | | | | | | | | | | | | | | | | | | | | | | | | | | | | | | | |
| 10: | 10.4 | ↗ | | | | | | | | | | | | | | | | | | | | | | | | | | | | | | | | | |
| Serie | 99.0 | | | | | | | | | | | | | | | | | | | | | | | | | | | | | | | | | | |
| Total | 99.0 | | | | | | | | | | | | | | | | | | | | | | | | | | | | | | | | | | |

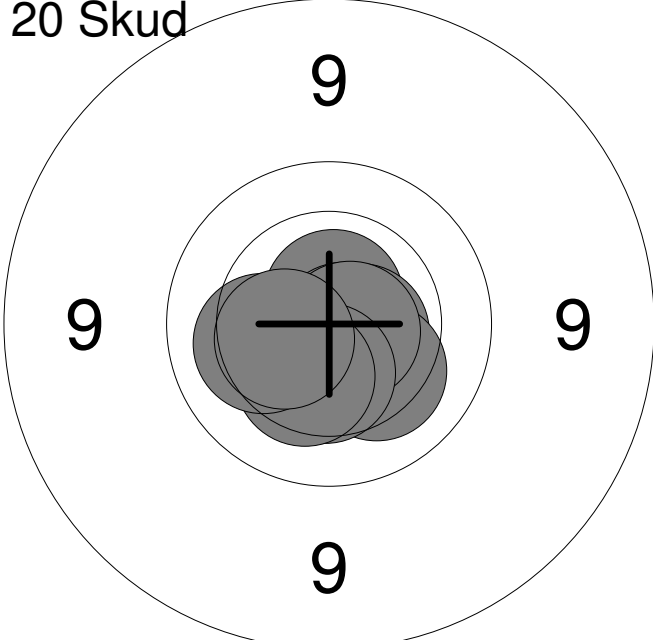
| | | | | | | | | | | | | | | | | | | | | | | | | | | | | | | | | | | | |
|--|--|-----|-------|---|-----|-------|---|-----|-------|---|-----|------|---|-----|------|---|-----|-------|---|-----|------|---|-----|------|---|-----|------|---|-----|------|---|-------|-------|-------|-------|
| <p>20 Skud</p>  | <table style="width:100%; border-collapse: collapse;"> <tr><td style="width:10%;">11:</td><td style="width:15%;">*10.7</td><td style="width:10%; text-align: center;">↑</td></tr> <tr><td>12:</td><td>*10.6</td><td style="text-align: center;">→</td></tr> <tr><td>13:</td><td>*10.8</td><td style="text-align: center;">↘</td></tr> <tr><td>14:</td><td>10.4</td><td style="text-align: center;">←</td></tr> <tr><td>15:</td><td>10.2</td><td style="text-align: center;">↘</td></tr> <tr><td>16:</td><td>*10.7</td><td style="text-align: center;">→</td></tr> <tr><td>17:</td><td>10.4</td><td style="text-align: center;">↓</td></tr> <tr><td>18:</td><td>10.3</td><td style="text-align: center;">↘</td></tr> <tr><td>19:</td><td>10.2</td><td style="text-align: center;">←</td></tr> <tr><td>20:</td><td>10.4</td><td style="text-align: center;">←</td></tr> </table> <table border="1" style="width:100%; border-collapse: collapse; margin-top: 5px;"> <tr> <td style="width:80%;">Serie</td> <td style="width:20%; text-align: right;">100.0</td> </tr> <tr> <td>Total</td> <td style="text-align: right;">199.0</td> </tr> </table> | 11: | *10.7 | ↑ | 12: | *10.6 | → | 13: | *10.8 | ↘ | 14: | 10.4 | ← | 15: | 10.2 | ↘ | 16: | *10.7 | → | 17: | 10.4 | ↓ | 18: | 10.3 | ↘ | 19: | 10.2 | ← | 20: | 10.4 | ← | Serie | 100.0 | Total | 199.0 |
| 11: | *10.7 | ↑ | | | | | | | | | | | | | | | | | | | | | | | | | | | | | | | | | |
| 12: | *10.6 | → | | | | | | | | | | | | | | | | | | | | | | | | | | | | | | | | | |
| 13: | *10.8 | ↘ | | | | | | | | | | | | | | | | | | | | | | | | | | | | | | | | | |
| 14: | 10.4 | ← | | | | | | | | | | | | | | | | | | | | | | | | | | | | | | | | | |
| 15: | 10.2 | ↘ | | | | | | | | | | | | | | | | | | | | | | | | | | | | | | | | | |
| 16: | *10.7 | → | | | | | | | | | | | | | | | | | | | | | | | | | | | | | | | | | |
| 17: | 10.4 | ↓ | | | | | | | | | | | | | | | | | | | | | | | | | | | | | | | | | |
| 18: | 10.3 | ↘ | | | | | | | | | | | | | | | | | | | | | | | | | | | | | | | | | |
| 19: | 10.2 | ← | | | | | | | | | | | | | | | | | | | | | | | | | | | | | | | | | |
| 20: | 10.4 | ← | | | | | | | | | | | | | | | | | | | | | | | | | | | | | | | | | |
| Serie | 100.0 | | | | | | | | | | | | | | | | | | | | | | | | | | | | | | | | | | |
| Total | 199.0 | | | | | | | | | | | | | | | | | | | | | | | | | | | | | | | | | | |

| | | | | | | | | | | | | | | | | | | | | | | | |
|---------------------|--|----|------|---|----|------|---|----|------|---|----|-------|---|----|------|---|----|------|---|-------|------|-------|-----|
| <p>Prøve</p> | <table style="width:100%; border-collapse: collapse;"> <tr><td style="text-align: right;">1:</td><td style="text-align: left;">10.1</td><td style="text-align: right;">↑</td></tr> <tr><td style="text-align: right;">2:</td><td style="text-align: left;">10.4</td><td style="text-align: right;">↗</td></tr> <tr><td style="text-align: right;">3:</td><td style="text-align: left;">10.1</td><td style="text-align: right;">↘</td></tr> <tr><td style="text-align: right;">4:</td><td style="text-align: left;">*10.6</td><td style="text-align: right;">↘</td></tr> <tr><td style="text-align: right;">5:</td><td style="text-align: left;">10.0</td><td style="text-align: right;">↓</td></tr> <tr><td style="text-align: right;">6:</td><td style="text-align: left;">10.4</td><td style="text-align: right;">↖</td></tr> </table> <table border="1" style="width:100%; border-collapse: collapse; margin-top: 5px;"> <tr> <td style="width:80%;">Serie</td> <td style="text-align: right;">60.0</td> </tr> <tr> <td>Total</td> <td style="text-align: right;">0.0</td> </tr> </table> | 1: | 10.1 | ↑ | 2: | 10.4 | ↗ | 3: | 10.1 | ↘ | 4: | *10.6 | ↘ | 5: | 10.0 | ↓ | 6: | 10.4 | ↖ | Serie | 60.0 | Total | 0.0 |
| 1: | 10.1 | ↑ | | | | | | | | | | | | | | | | | | | | | |
| 2: | 10.4 | ↗ | | | | | | | | | | | | | | | | | | | | | |
| 3: | 10.1 | ↘ | | | | | | | | | | | | | | | | | | | | | |
| 4: | *10.6 | ↘ | | | | | | | | | | | | | | | | | | | | | |
| 5: | 10.0 | ↓ | | | | | | | | | | | | | | | | | | | | | |
| 6: | 10.4 | ↖ | | | | | | | | | | | | | | | | | | | | | |
| Serie | 60.0 | | | | | | | | | | | | | | | | | | | | | | |
| Total | 0.0 | | | | | | | | | | | | | | | | | | | | | | |

| | | | | | | | | | | | | | | | | | | | | | | | | | | | | | | | | | | | |
|-----------------------|--|----|------|---|----|------|---|----|-------|---|----|-------|---|----|------|---|----|-----|---|----|-------|---|----|-------|---|----|-----|---|-----|-------|---|-------|------|-------|------|
| <p>20 Skud</p> | <table style="width:100%; border-collapse: collapse;"> <tr><td style="text-align: right;">1:</td><td style="text-align: left;">10.3</td><td style="text-align: right;">↖</td></tr> <tr><td style="text-align: right;">2:</td><td style="text-align: left;">10.0</td><td style="text-align: right;">↘</td></tr> <tr><td style="text-align: right;">3:</td><td style="text-align: left;">*10.6</td><td style="text-align: right;">↖</td></tr> <tr><td style="text-align: right;">4:</td><td style="text-align: left;">*10.6</td><td style="text-align: right;">↑</td></tr> <tr><td style="text-align: right;">5:</td><td style="text-align: left;">10.4</td><td style="text-align: right;">↖</td></tr> <tr><td style="text-align: right;">6:</td><td style="text-align: left;">9.9</td><td style="text-align: right;">↗</td></tr> <tr><td style="text-align: right;">7:</td><td style="text-align: left;">*10.9</td><td style="text-align: right;">↘</td></tr> <tr><td style="text-align: right;">8:</td><td style="text-align: left;">*10.7</td><td style="text-align: right;">↑</td></tr> <tr><td style="text-align: right;">9:</td><td style="text-align: left;">9.8</td><td style="text-align: right;">↑</td></tr> <tr><td style="text-align: right;">10:</td><td style="text-align: left;">*10.6</td><td style="text-align: right;">↖</td></tr> </table> <table border="1" style="width:100%; border-collapse: collapse; margin-top: 5px;"> <tr> <td style="width:80%;">Serie</td> <td style="text-align: right;">98.0</td> </tr> <tr> <td>Total</td> <td style="text-align: right;">98.0</td> </tr> </table> | 1: | 10.3 | ↖ | 2: | 10.0 | ↘ | 3: | *10.6 | ↖ | 4: | *10.6 | ↑ | 5: | 10.4 | ↖ | 6: | 9.9 | ↗ | 7: | *10.9 | ↘ | 8: | *10.7 | ↑ | 9: | 9.8 | ↑ | 10: | *10.6 | ↖ | Serie | 98.0 | Total | 98.0 |
| 1: | 10.3 | ↖ | | | | | | | | | | | | | | | | | | | | | | | | | | | | | | | | | |
| 2: | 10.0 | ↘ | | | | | | | | | | | | | | | | | | | | | | | | | | | | | | | | | |
| 3: | *10.6 | ↖ | | | | | | | | | | | | | | | | | | | | | | | | | | | | | | | | | |
| 4: | *10.6 | ↑ | | | | | | | | | | | | | | | | | | | | | | | | | | | | | | | | | |
| 5: | 10.4 | ↖ | | | | | | | | | | | | | | | | | | | | | | | | | | | | | | | | | |
| 6: | 9.9 | ↗ | | | | | | | | | | | | | | | | | | | | | | | | | | | | | | | | | |
| 7: | *10.9 | ↘ | | | | | | | | | | | | | | | | | | | | | | | | | | | | | | | | | |
| 8: | *10.7 | ↑ | | | | | | | | | | | | | | | | | | | | | | | | | | | | | | | | | |
| 9: | 9.8 | ↑ | | | | | | | | | | | | | | | | | | | | | | | | | | | | | | | | | |
| 10: | *10.6 | ↖ | | | | | | | | | | | | | | | | | | | | | | | | | | | | | | | | | |
| Serie | 98.0 | | | | | | | | | | | | | | | | | | | | | | | | | | | | | | | | | | |
| Total | 98.0 | | | | | | | | | | | | | | | | | | | | | | | | | | | | | | | | | | |

| | | | | | | | | | | | | | | | | | | | | | | | | | | | | | | | | | | | |
|-----------------------|---|-----|------|---|-----|-----|---|-----|------|---|-----|------|---|-----|------|---|-----|------|---|-----|-----|---|-----|------|---|-----|-------|---|-----|-------|---|-------|------|-------|-------|
| <p>20 Skud</p> | <table style="width:100%; border-collapse: collapse;"> <tr><td style="text-align: right;">11:</td><td style="text-align: left;">10.3</td><td style="text-align: right;">↖</td></tr> <tr><td style="text-align: right;">12:</td><td style="text-align: left;">9.8</td><td style="text-align: right;">→</td></tr> <tr><td style="text-align: right;">13:</td><td style="text-align: left;">10.2</td><td style="text-align: right;">↗</td></tr> <tr><td style="text-align: right;">14:</td><td style="text-align: left;">10.3</td><td style="text-align: right;">↓</td></tr> <tr><td style="text-align: right;">15:</td><td style="text-align: left;">10.1</td><td style="text-align: right;">↑</td></tr> <tr><td style="text-align: right;">16:</td><td style="text-align: left;">10.4</td><td style="text-align: right;">↗</td></tr> <tr><td style="text-align: right;">17:</td><td style="text-align: left;">9.8</td><td style="text-align: right;">↖</td></tr> <tr><td style="text-align: right;">18:</td><td style="text-align: left;">10.1</td><td style="text-align: right;">↗</td></tr> <tr><td style="text-align: right;">19:</td><td style="text-align: left;">*10.8</td><td style="text-align: right;">↖</td></tr> <tr><td style="text-align: right;">20:</td><td style="text-align: left;">*10.6</td><td style="text-align: right;">↓</td></tr> </table> <table border="1" style="width:100%; border-collapse: collapse; margin-top: 5px;"> <tr> <td style="width:80%;">Serie</td> <td style="text-align: right;">98.0</td> </tr> <tr> <td>Total</td> <td style="text-align: right;">196.0</td> </tr> </table> | 11: | 10.3 | ↖ | 12: | 9.8 | → | 13: | 10.2 | ↗ | 14: | 10.3 | ↓ | 15: | 10.1 | ↑ | 16: | 10.4 | ↗ | 17: | 9.8 | ↖ | 18: | 10.1 | ↗ | 19: | *10.8 | ↖ | 20: | *10.6 | ↓ | Serie | 98.0 | Total | 196.0 |
| 11: | 10.3 | ↖ | | | | | | | | | | | | | | | | | | | | | | | | | | | | | | | | | |
| 12: | 9.8 | → | | | | | | | | | | | | | | | | | | | | | | | | | | | | | | | | | |
| 13: | 10.2 | ↗ | | | | | | | | | | | | | | | | | | | | | | | | | | | | | | | | | |
| 14: | 10.3 | ↓ | | | | | | | | | | | | | | | | | | | | | | | | | | | | | | | | | |
| 15: | 10.1 | ↑ | | | | | | | | | | | | | | | | | | | | | | | | | | | | | | | | | |
| 16: | 10.4 | ↗ | | | | | | | | | | | | | | | | | | | | | | | | | | | | | | | | | |
| 17: | 9.8 | ↖ | | | | | | | | | | | | | | | | | | | | | | | | | | | | | | | | | |
| 18: | 10.1 | ↗ | | | | | | | | | | | | | | | | | | | | | | | | | | | | | | | | | |
| 19: | *10.8 | ↖ | | | | | | | | | | | | | | | | | | | | | | | | | | | | | | | | | |
| 20: | *10.6 | ↓ | | | | | | | | | | | | | | | | | | | | | | | | | | | | | | | | | |
| Serie | 98.0 | | | | | | | | | | | | | | | | | | | | | | | | | | | | | | | | | | |
| Total | 196.0 | | | | | | | | | | | | | | | | | | | | | | | | | | | | | | | | | | |

| | | | | | | | | | | | | | | | | | | | | |
|---------------------|---|----|-----|---|----|------|---|----|-------|---|----|------|---|----|------|---|-------|------|-------|-----|
| <p>Prøve</p> | <table style="width:100%; border-collapse: collapse;"> <tr><td style="text-align:right;">1:</td><td style="text-align:left;">9.4</td><td style="text-align:right;">→</td></tr> <tr><td style="text-align:right;">2:</td><td style="text-align:left;">10.0</td><td style="text-align:right;">←</td></tr> <tr><td style="text-align:right;">3:</td><td style="text-align:left;">*10.5</td><td style="text-align:right;">←</td></tr> <tr><td style="text-align:right;">4:</td><td style="text-align:left;">10.2</td><td style="text-align:right;">↓</td></tr> <tr><td style="text-align:right;">5:</td><td style="text-align:left;">10.5</td><td style="text-align:right;">↑</td></tr> </table> <table border="1" style="width:100%; border-collapse: collapse; margin-top: 10px;"> <tr> <td style="width:80%;">Serie</td> <td style="text-align:right;">49.0</td> </tr> <tr> <td>Total</td> <td style="text-align:right;">0.0</td> </tr> </table> | 1: | 9.4 | → | 2: | 10.0 | ← | 3: | *10.5 | ← | 4: | 10.2 | ↓ | 5: | 10.5 | ↑ | Serie | 49.0 | Total | 0.0 |
| 1: | 9.4 | → | | | | | | | | | | | | | | | | | | |
| 2: | 10.0 | ← | | | | | | | | | | | | | | | | | | |
| 3: | *10.5 | ← | | | | | | | | | | | | | | | | | | |
| 4: | 10.2 | ↓ | | | | | | | | | | | | | | | | | | |
| 5: | 10.5 | ↑ | | | | | | | | | | | | | | | | | | |
| Serie | 49.0 | | | | | | | | | | | | | | | | | | | |
| Total | 0.0 | | | | | | | | | | | | | | | | | | | |

| | | | | | | | | | | | | | | | | | | | | | | | | | | | | | | | | | | | |
|-----------------------|---|----|-------|---|----|-----|---|----|------|---|----|------|---|----|-------|---|----|-----|---|----|------|---|----|------|---|----|------|---|-----|-------|---|-------|------|-------|------|
| <p>20 Skud</p> | <table style="width:100%; border-collapse: collapse;"> <tr><td style="text-align:right;">1:</td><td style="text-align:left;">*10.7</td><td style="text-align:right;">↖</td></tr> <tr><td style="text-align:right;">2:</td><td style="text-align:left;">9.8</td><td style="text-align:right;">↘</td></tr> <tr><td style="text-align:right;">3:</td><td style="text-align:left;">10.4</td><td style="text-align:right;">→</td></tr> <tr><td style="text-align:right;">4:</td><td style="text-align:left;">10.0</td><td style="text-align:right;">↘</td></tr> <tr><td style="text-align:right;">5:</td><td style="text-align:left;">*10.8</td><td style="text-align:right;">↘</td></tr> <tr><td style="text-align:right;">6:</td><td style="text-align:left;">9.9</td><td style="text-align:right;">↑</td></tr> <tr><td style="text-align:right;">7:</td><td style="text-align:left;">10.4</td><td style="text-align:right;">↗</td></tr> <tr><td style="text-align:right;">8:</td><td style="text-align:left;">10.3</td><td style="text-align:right;">←</td></tr> <tr><td style="text-align:right;">9:</td><td style="text-align:left;">10.2</td><td style="text-align:right;">→</td></tr> <tr><td style="text-align:right;">10:</td><td style="text-align:left;">*10.6</td><td style="text-align:right;">→</td></tr> </table> <table border="1" style="width:100%; border-collapse: collapse; margin-top: 10px;"> <tr> <td style="width:80%;">Serie</td> <td style="text-align:right;">98.0</td> </tr> <tr> <td>Total</td> <td style="text-align:right;">98.0</td> </tr> </table> | 1: | *10.7 | ↖ | 2: | 9.8 | ↘ | 3: | 10.4 | → | 4: | 10.0 | ↘ | 5: | *10.8 | ↘ | 6: | 9.9 | ↑ | 7: | 10.4 | ↗ | 8: | 10.3 | ← | 9: | 10.2 | → | 10: | *10.6 | → | Serie | 98.0 | Total | 98.0 |
| 1: | *10.7 | ↖ | | | | | | | | | | | | | | | | | | | | | | | | | | | | | | | | | |
| 2: | 9.8 | ↘ | | | | | | | | | | | | | | | | | | | | | | | | | | | | | | | | | |
| 3: | 10.4 | → | | | | | | | | | | | | | | | | | | | | | | | | | | | | | | | | | |
| 4: | 10.0 | ↘ | | | | | | | | | | | | | | | | | | | | | | | | | | | | | | | | | |
| 5: | *10.8 | ↘ | | | | | | | | | | | | | | | | | | | | | | | | | | | | | | | | | |
| 6: | 9.9 | ↑ | | | | | | | | | | | | | | | | | | | | | | | | | | | | | | | | | |
| 7: | 10.4 | ↗ | | | | | | | | | | | | | | | | | | | | | | | | | | | | | | | | | |
| 8: | 10.3 | ← | | | | | | | | | | | | | | | | | | | | | | | | | | | | | | | | | |
| 9: | 10.2 | → | | | | | | | | | | | | | | | | | | | | | | | | | | | | | | | | | |
| 10: | *10.6 | → | | | | | | | | | | | | | | | | | | | | | | | | | | | | | | | | | |
| Serie | 98.0 | | | | | | | | | | | | | | | | | | | | | | | | | | | | | | | | | | |
| Total | 98.0 | | | | | | | | | | | | | | | | | | | | | | | | | | | | | | | | | | |

| | | | | | | | | | | | | | | | | | | | | | | | | | | | | | | | | | | | |
|-----------------------|---|-----|-----|---|-----|-------|---|-----|-------|---|-----|-----|---|-----|-----|---|-----|------|---|-----|------|---|-----|-----|---|-----|------|---|-----|-----|---|-------|------|-------|-------|
| <p>20 Skud</p> | <table style="width:100%; border-collapse: collapse;"> <tr><td style="text-align:right;">11:</td><td style="text-align:left;">9.6</td><td style="text-align:right;">↗</td></tr> <tr><td style="text-align:right;">12:</td><td style="text-align:left;">*10.6</td><td style="text-align:right;">→</td></tr> <tr><td style="text-align:right;">13:</td><td style="text-align:left;">*10.8</td><td style="text-align:right;">↑</td></tr> <tr><td style="text-align:right;">14:</td><td style="text-align:left;">9.9</td><td style="text-align:right;">→</td></tr> <tr><td style="text-align:right;">15:</td><td style="text-align:left;">9.9</td><td style="text-align:right;">↗</td></tr> <tr><td style="text-align:right;">16:</td><td style="text-align:left;">10.2</td><td style="text-align:right;">↑</td></tr> <tr><td style="text-align:right;">17:</td><td style="text-align:left;">10.2</td><td style="text-align:right;">↗</td></tr> <tr><td style="text-align:right;">18:</td><td style="text-align:left;">9.9</td><td style="text-align:right;">↖</td></tr> <tr><td style="text-align:right;">19:</td><td style="text-align:left;">10.0</td><td style="text-align:right;">↑</td></tr> <tr><td style="text-align:right;">20:</td><td style="text-align:left;">9.8</td><td style="text-align:right;">→</td></tr> </table> <table border="1" style="width:100%; border-collapse: collapse; margin-top: 10px;"> <tr> <td style="width:80%;">Serie</td> <td style="text-align:right;">95.0</td> </tr> <tr> <td>Total</td> <td style="text-align:right;">193.0</td> </tr> </table> | 11: | 9.6 | ↗ | 12: | *10.6 | → | 13: | *10.8 | ↑ | 14: | 9.9 | → | 15: | 9.9 | ↗ | 16: | 10.2 | ↑ | 17: | 10.2 | ↗ | 18: | 9.9 | ↖ | 19: | 10.0 | ↑ | 20: | 9.8 | → | Serie | 95.0 | Total | 193.0 |
| 11: | 9.6 | ↗ | | | | | | | | | | | | | | | | | | | | | | | | | | | | | | | | | |
| 12: | *10.6 | → | | | | | | | | | | | | | | | | | | | | | | | | | | | | | | | | | |
| 13: | *10.8 | ↑ | | | | | | | | | | | | | | | | | | | | | | | | | | | | | | | | | |
| 14: | 9.9 | → | | | | | | | | | | | | | | | | | | | | | | | | | | | | | | | | | |
| 15: | 9.9 | ↗ | | | | | | | | | | | | | | | | | | | | | | | | | | | | | | | | | |
| 16: | 10.2 | ↑ | | | | | | | | | | | | | | | | | | | | | | | | | | | | | | | | | |
| 17: | 10.2 | ↗ | | | | | | | | | | | | | | | | | | | | | | | | | | | | | | | | | |
| 18: | 9.9 | ↖ | | | | | | | | | | | | | | | | | | | | | | | | | | | | | | | | | |
| 19: | 10.0 | ↑ | | | | | | | | | | | | | | | | | | | | | | | | | | | | | | | | | |
| 20: | 9.8 | → | | | | | | | | | | | | | | | | | | | | | | | | | | | | | | | | | |
| Serie | 95.0 | | | | | | | | | | | | | | | | | | | | | | | | | | | | | | | | | | |
| Total | 193.0 | | | | | | | | | | | | | | | | | | | | | | | | | | | | | | | | | | |

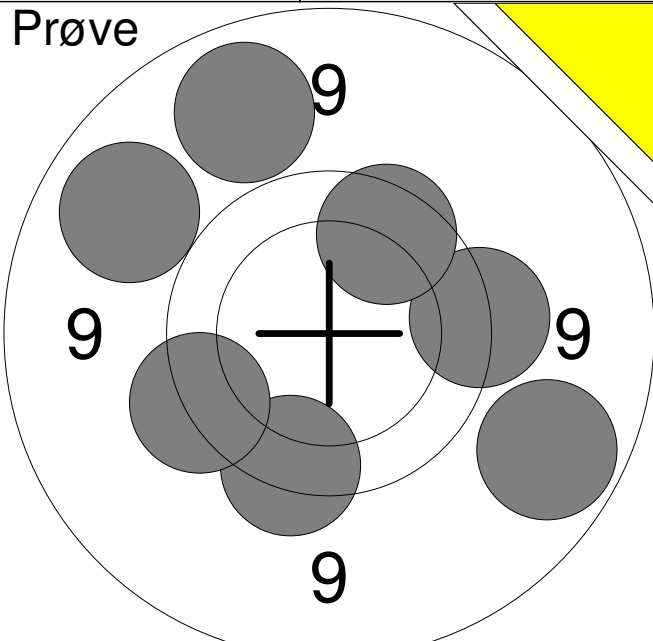
| | | | | | | | | | | | | | | | | | | | | | | | | | | |
|--|--|----|-----|---|----|-----|---|----|-----|---|----|-----|---|----|-----|---|----|-----|---|----|-----|---|-------|------|-------|-----|
| <p>Prøve</p>  | <table style="width:100%; border-collapse: collapse;"> <tr><td style="width:10%;">1:</td><td style="width:15%;">9.1</td><td style="width:10%; text-align: right;">↗</td></tr> <tr><td>2:</td><td>9.6</td><td style="text-align: right;">→</td></tr> <tr><td>3:</td><td>9.0</td><td style="text-align: right;">↘</td></tr> <tr><td>4:</td><td>9.7</td><td style="text-align: right;">↓</td></tr> <tr><td>5:</td><td>9.8</td><td style="text-align: right;">↗</td></tr> <tr><td>6:</td><td>9.1</td><td style="text-align: right;">↗</td></tr> <tr><td>7:</td><td>9.6</td><td style="text-align: right;">↙</td></tr> </table> <table border="1" style="width:100%; border-collapse: collapse; margin-top: 5px;"> <tr> <td style="width:80%;">Serie</td> <td style="text-align: right;">63.0</td> </tr> <tr> <td>Total</td> <td style="text-align: right;">0.0</td> </tr> </table> | 1: | 9.1 | ↗ | 2: | 9.6 | → | 3: | 9.0 | ↘ | 4: | 9.7 | ↓ | 5: | 9.8 | ↗ | 6: | 9.1 | ↗ | 7: | 9.6 | ↙ | Serie | 63.0 | Total | 0.0 |
| 1: | 9.1 | ↗ | | | | | | | | | | | | | | | | | | | | | | | | |
| 2: | 9.6 | → | | | | | | | | | | | | | | | | | | | | | | | | |
| 3: | 9.0 | ↘ | | | | | | | | | | | | | | | | | | | | | | | | |
| 4: | 9.7 | ↓ | | | | | | | | | | | | | | | | | | | | | | | | |
| 5: | 9.8 | ↗ | | | | | | | | | | | | | | | | | | | | | | | | |
| 6: | 9.1 | ↗ | | | | | | | | | | | | | | | | | | | | | | | | |
| 7: | 9.6 | ↙ | | | | | | | | | | | | | | | | | | | | | | | | |
| Serie | 63.0 | | | | | | | | | | | | | | | | | | | | | | | | | |
| Total | 0.0 | | | | | | | | | | | | | | | | | | | | | | | | | |

| | | | | | | | | | | | | | | | | | | | | | | | | | | | | | | | | | | | |
|---|---|----|-----|---|----|-----|---|----|-----|---|----|-----|---|----|-----|---|----|-------|---|----|-----|---|----|-----|---|----|------|---|-----|-----|---|-------|------|-------|------|
| <p>20 Skud</p>  | <table style="width:100%; border-collapse: collapse;"> <tr><td style="width:10%;">1:</td><td style="width:15%;">6.4</td><td style="width:10%; text-align: right;">↗</td></tr> <tr><td>2:</td><td>8.7</td><td style="text-align: right;">↗</td></tr> <tr><td>3:</td><td>8.2</td><td style="text-align: right;">→</td></tr> <tr><td>4:</td><td>7.7</td><td style="text-align: right;">↘</td></tr> <tr><td>5:</td><td>9.7</td><td style="text-align: right;">↗</td></tr> <tr><td>6:</td><td>*10.9</td><td style="text-align: right;">↗</td></tr> <tr><td>7:</td><td>8.4</td><td style="text-align: right;">→</td></tr> <tr><td>8:</td><td>9.7</td><td style="text-align: right;">↓</td></tr> <tr><td>9:</td><td>10.0</td><td style="text-align: right;">↗</td></tr> <tr><td>10:</td><td>9.4</td><td style="text-align: right;">↓</td></tr> </table> <table border="1" style="width:100%; border-collapse: collapse; margin-top: 5px;"> <tr> <td style="width:80%;">Serie</td> <td style="text-align: right;">84.0</td> </tr> <tr> <td>Total</td> <td style="text-align: right;">84.0</td> </tr> </table> | 1: | 6.4 | ↗ | 2: | 8.7 | ↗ | 3: | 8.2 | → | 4: | 7.7 | ↘ | 5: | 9.7 | ↗ | 6: | *10.9 | ↗ | 7: | 8.4 | → | 8: | 9.7 | ↓ | 9: | 10.0 | ↗ | 10: | 9.4 | ↓ | Serie | 84.0 | Total | 84.0 |
| 1: | 6.4 | ↗ | | | | | | | | | | | | | | | | | | | | | | | | | | | | | | | | | |
| 2: | 8.7 | ↗ | | | | | | | | | | | | | | | | | | | | | | | | | | | | | | | | | |
| 3: | 8.2 | → | | | | | | | | | | | | | | | | | | | | | | | | | | | | | | | | | |
| 4: | 7.7 | ↘ | | | | | | | | | | | | | | | | | | | | | | | | | | | | | | | | | |
| 5: | 9.7 | ↗ | | | | | | | | | | | | | | | | | | | | | | | | | | | | | | | | | |
| 6: | *10.9 | ↗ | | | | | | | | | | | | | | | | | | | | | | | | | | | | | | | | | |
| 7: | 8.4 | → | | | | | | | | | | | | | | | | | | | | | | | | | | | | | | | | | |
| 8: | 9.7 | ↓ | | | | | | | | | | | | | | | | | | | | | | | | | | | | | | | | | |
| 9: | 10.0 | ↗ | | | | | | | | | | | | | | | | | | | | | | | | | | | | | | | | | |
| 10: | 9.4 | ↓ | | | | | | | | | | | | | | | | | | | | | | | | | | | | | | | | | |
| Serie | 84.0 | | | | | | | | | | | | | | | | | | | | | | | | | | | | | | | | | | |
| Total | 84.0 | | | | | | | | | | | | | | | | | | | | | | | | | | | | | | | | | | |

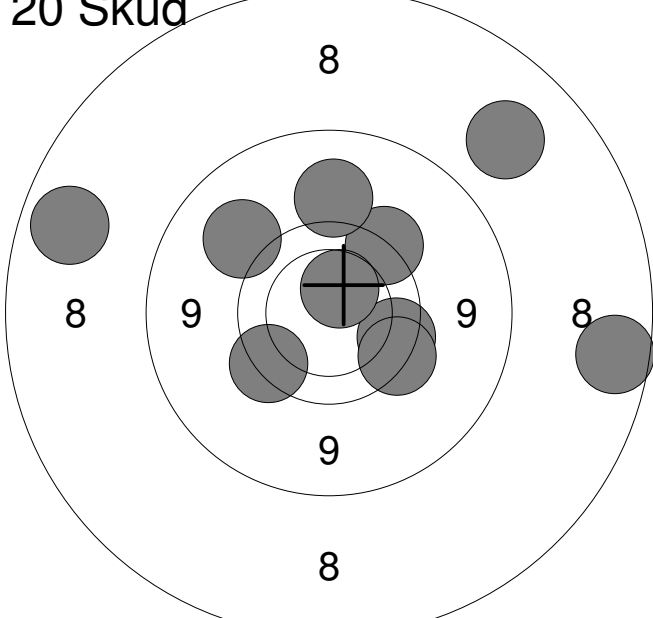
| | | | | | | | | | | | | | | | | | | | | | | | | | | | | | | | | | | | |
|--|---|-----|-----|---|-----|-----|---|-----|-----|---|-----|-----|---|-----|-----|---|-----|-----|---|-----|-----|---|-----|------|---|-----|-----|---|-----|-----|---|-------|------|-------|-------|
| <p>20 Skud</p>  | <table style="width:100%; border-collapse: collapse;"> <tr><td style="width:10%;">11:</td><td style="width:15%;">9.6</td><td style="width:10%; text-align: right;">↗</td></tr> <tr><td>12:</td><td>8.2</td><td style="text-align: right;">↗</td></tr> <tr><td>13:</td><td>9.7</td><td style="text-align: right;">↙</td></tr> <tr><td>14:</td><td>9.3</td><td style="text-align: right;">↗</td></tr> <tr><td>15:</td><td>9.7</td><td style="text-align: right;">↘</td></tr> <tr><td>16:</td><td>9.6</td><td style="text-align: right;">↘</td></tr> <tr><td>17:</td><td>8.0</td><td style="text-align: right;">↗</td></tr> <tr><td>18:</td><td>10.4</td><td style="text-align: right;">↗</td></tr> <tr><td>19:</td><td>9.3</td><td style="text-align: right;">↗</td></tr> <tr><td>20:</td><td>7.9</td><td style="text-align: right;">→</td></tr> </table> <table border="1" style="width:100%; border-collapse: collapse; margin-top: 5px;"> <tr> <td style="width:80%;">Serie</td> <td style="text-align: right;">87.0</td> </tr> <tr> <td>Total</td> <td style="text-align: right;">171.0</td> </tr> </table> | 11: | 9.6 | ↗ | 12: | 8.2 | ↗ | 13: | 9.7 | ↙ | 14: | 9.3 | ↗ | 15: | 9.7 | ↘ | 16: | 9.6 | ↘ | 17: | 8.0 | ↗ | 18: | 10.4 | ↗ | 19: | 9.3 | ↗ | 20: | 7.9 | → | Serie | 87.0 | Total | 171.0 |
| 11: | 9.6 | ↗ | | | | | | | | | | | | | | | | | | | | | | | | | | | | | | | | | |
| 12: | 8.2 | ↗ | | | | | | | | | | | | | | | | | | | | | | | | | | | | | | | | | |
| 13: | 9.7 | ↙ | | | | | | | | | | | | | | | | | | | | | | | | | | | | | | | | | |
| 14: | 9.3 | ↗ | | | | | | | | | | | | | | | | | | | | | | | | | | | | | | | | | |
| 15: | 9.7 | ↘ | | | | | | | | | | | | | | | | | | | | | | | | | | | | | | | | | |
| 16: | 9.6 | ↘ | | | | | | | | | | | | | | | | | | | | | | | | | | | | | | | | | |
| 17: | 8.0 | ↗ | | | | | | | | | | | | | | | | | | | | | | | | | | | | | | | | | |
| 18: | 10.4 | ↗ | | | | | | | | | | | | | | | | | | | | | | | | | | | | | | | | | |
| 19: | 9.3 | ↗ | | | | | | | | | | | | | | | | | | | | | | | | | | | | | | | | | |
| 20: | 7.9 | → | | | | | | | | | | | | | | | | | | | | | | | | | | | | | | | | | |
| Serie | 87.0 | | | | | | | | | | | | | | | | | | | | | | | | | | | | | | | | | | |
| Total | 171.0 | | | | | | | | | | | | | | | | | | | | | | | | | | | | | | | | | | |

| | | | | | | | | | | | | | | | | | | | | |
|---------------------|--|----|-----|---|----|------|---|----|------|---|----|------|---|----|------|---|-------|------|-------|-----|
| <p>Prøve</p> | <table style="width:100%; border-collapse: collapse;"> <tr><td style="text-align: right;">1:</td><td style="text-align: right;">9.9</td><td style="text-align: right;">↗</td></tr> <tr><td style="text-align: right;">2:</td><td style="text-align: right;">10.3</td><td style="text-align: right;">←</td></tr> <tr><td style="text-align: right;">3:</td><td style="text-align: right;">10.0</td><td style="text-align: right;">↖</td></tr> <tr><td style="text-align: right;">4:</td><td style="text-align: right;">10.3</td><td style="text-align: right;">↑</td></tr> <tr><td style="text-align: right;">5:</td><td style="text-align: right;">10.2</td><td style="text-align: right;">↗</td></tr> </table> <table border="1" style="width:100%; border-collapse: collapse; margin-top: 10px;"> <tr> <td style="width:80%;">Serie</td> <td style="text-align: right;">49.0</td> </tr> <tr> <td>Total</td> <td style="text-align: right;">0.0</td> </tr> </table> | 1: | 9.9 | ↗ | 2: | 10.3 | ← | 3: | 10.0 | ↖ | 4: | 10.3 | ↑ | 5: | 10.2 | ↗ | Serie | 49.0 | Total | 0.0 |
| 1: | 9.9 | ↗ | | | | | | | | | | | | | | | | | | |
| 2: | 10.3 | ← | | | | | | | | | | | | | | | | | | |
| 3: | 10.0 | ↖ | | | | | | | | | | | | | | | | | | |
| 4: | 10.3 | ↑ | | | | | | | | | | | | | | | | | | |
| 5: | 10.2 | ↗ | | | | | | | | | | | | | | | | | | |
| Serie | 49.0 | | | | | | | | | | | | | | | | | | | |
| Total | 0.0 | | | | | | | | | | | | | | | | | | | |

| | | | | | | | | | | | | | | | | | | | | | | | | | | | | | | | | | | | |
|-----------------------|---|----|------|---|----|-------|---|----|-----|---|----|------|---|----|-------|---|----|------|---|----|-------|---|----|-------|---|----|------|---|-----|------|---|-------|------|-------|------|
| <p>20 Skud</p> | <table style="width:100%; border-collapse: collapse;"> <tr><td style="text-align: right;">1:</td><td style="text-align: right;">10.5</td><td style="text-align: right;">↗</td></tr> <tr><td style="text-align: right;">2:</td><td style="text-align: right;">*10.6</td><td style="text-align: right;">↑</td></tr> <tr><td style="text-align: right;">3:</td><td style="text-align: right;">9.8</td><td style="text-align: right;">↗</td></tr> <tr><td style="text-align: right;">4:</td><td style="text-align: right;">10.5</td><td style="text-align: right;">←</td></tr> <tr><td style="text-align: right;">5:</td><td style="text-align: right;">*10.8</td><td style="text-align: right;">↘</td></tr> <tr><td style="text-align: right;">6:</td><td style="text-align: right;">10.0</td><td style="text-align: right;">↘</td></tr> <tr><td style="text-align: right;">7:</td><td style="text-align: right;">*10.6</td><td style="text-align: right;">↗</td></tr> <tr><td style="text-align: right;">8:</td><td style="text-align: right;">*10.5</td><td style="text-align: right;">→</td></tr> <tr><td style="text-align: right;">9:</td><td style="text-align: right;">10.2</td><td style="text-align: right;">↗</td></tr> <tr><td style="text-align: right;">10:</td><td style="text-align: right;">10.0</td><td style="text-align: right;">↘</td></tr> </table> <table border="1" style="width:100%; border-collapse: collapse; margin-top: 10px;"> <tr> <td style="width:80%;">Serie</td> <td style="text-align: right;">99.0</td> </tr> <tr> <td>Total</td> <td style="text-align: right;">99.0</td> </tr> </table> | 1: | 10.5 | ↗ | 2: | *10.6 | ↑ | 3: | 9.8 | ↗ | 4: | 10.5 | ← | 5: | *10.8 | ↘ | 6: | 10.0 | ↘ | 7: | *10.6 | ↗ | 8: | *10.5 | → | 9: | 10.2 | ↗ | 10: | 10.0 | ↘ | Serie | 99.0 | Total | 99.0 |
| 1: | 10.5 | ↗ | | | | | | | | | | | | | | | | | | | | | | | | | | | | | | | | | |
| 2: | *10.6 | ↑ | | | | | | | | | | | | | | | | | | | | | | | | | | | | | | | | | |
| 3: | 9.8 | ↗ | | | | | | | | | | | | | | | | | | | | | | | | | | | | | | | | | |
| 4: | 10.5 | ← | | | | | | | | | | | | | | | | | | | | | | | | | | | | | | | | | |
| 5: | *10.8 | ↘ | | | | | | | | | | | | | | | | | | | | | | | | | | | | | | | | | |
| 6: | 10.0 | ↘ | | | | | | | | | | | | | | | | | | | | | | | | | | | | | | | | | |
| 7: | *10.6 | ↗ | | | | | | | | | | | | | | | | | | | | | | | | | | | | | | | | | |
| 8: | *10.5 | → | | | | | | | | | | | | | | | | | | | | | | | | | | | | | | | | | |
| 9: | 10.2 | ↗ | | | | | | | | | | | | | | | | | | | | | | | | | | | | | | | | | |
| 10: | 10.0 | ↘ | | | | | | | | | | | | | | | | | | | | | | | | | | | | | | | | | |
| Serie | 99.0 | | | | | | | | | | | | | | | | | | | | | | | | | | | | | | | | | | |
| Total | 99.0 | | | | | | | | | | | | | | | | | | | | | | | | | | | | | | | | | | |

| | | | | | | | | | | | | | | | | | | | | | | | | | | | | | | | | | | | |
|-----------------------|---|-----|------|---|-----|-------|---|-----|-------|---|-----|-----|---|-----|------|---|-----|------|---|-----|-------|---|-----|------|---|-----|-------|---|-----|------|---|-------|------|-------|-------|
| <p>20 Skud</p> | <table style="width:100%; border-collapse: collapse;"> <tr><td style="text-align: right;">11:</td><td style="text-align: right;">10.5</td><td style="text-align: right;">→</td></tr> <tr><td style="text-align: right;">12:</td><td style="text-align: right;">*10.5</td><td style="text-align: right;">↗</td></tr> <tr><td style="text-align: right;">13:</td><td style="text-align: right;">*10.5</td><td style="text-align: right;">↑</td></tr> <tr><td style="text-align: right;">14:</td><td style="text-align: right;">9.7</td><td style="text-align: right;">→</td></tr> <tr><td style="text-align: right;">15:</td><td style="text-align: right;">10.4</td><td style="text-align: right;">↗</td></tr> <tr><td style="text-align: right;">16:</td><td style="text-align: right;">10.4</td><td style="text-align: right;">↘</td></tr> <tr><td style="text-align: right;">17:</td><td style="text-align: right;">*10.6</td><td style="text-align: right;">←</td></tr> <tr><td style="text-align: right;">18:</td><td style="text-align: right;">10.2</td><td style="text-align: right;">→</td></tr> <tr><td style="text-align: right;">19:</td><td style="text-align: right;">*10.8</td><td style="text-align: right;">←</td></tr> <tr><td style="text-align: right;">20:</td><td style="text-align: right;">10.5</td><td style="text-align: right;">→</td></tr> </table> <table border="1" style="width:100%; border-collapse: collapse; margin-top: 10px;"> <tr> <td style="width:80%;">Serie</td> <td style="text-align: right;">99.0</td> </tr> <tr> <td>Total</td> <td style="text-align: right;">198.0</td> </tr> </table> | 11: | 10.5 | → | 12: | *10.5 | ↗ | 13: | *10.5 | ↑ | 14: | 9.7 | → | 15: | 10.4 | ↗ | 16: | 10.4 | ↘ | 17: | *10.6 | ← | 18: | 10.2 | → | 19: | *10.8 | ← | 20: | 10.5 | → | Serie | 99.0 | Total | 198.0 |
| 11: | 10.5 | → | | | | | | | | | | | | | | | | | | | | | | | | | | | | | | | | | |
| 12: | *10.5 | ↗ | | | | | | | | | | | | | | | | | | | | | | | | | | | | | | | | | |
| 13: | *10.5 | ↑ | | | | | | | | | | | | | | | | | | | | | | | | | | | | | | | | | |
| 14: | 9.7 | → | | | | | | | | | | | | | | | | | | | | | | | | | | | | | | | | | |
| 15: | 10.4 | ↗ | | | | | | | | | | | | | | | | | | | | | | | | | | | | | | | | | |
| 16: | 10.4 | ↘ | | | | | | | | | | | | | | | | | | | | | | | | | | | | | | | | | |
| 17: | *10.6 | ← | | | | | | | | | | | | | | | | | | | | | | | | | | | | | | | | | |
| 18: | 10.2 | → | | | | | | | | | | | | | | | | | | | | | | | | | | | | | | | | | |
| 19: | *10.8 | ← | | | | | | | | | | | | | | | | | | | | | | | | | | | | | | | | | |
| 20: | 10.5 | → | | | | | | | | | | | | | | | | | | | | | | | | | | | | | | | | | |
| Serie | 99.0 | | | | | | | | | | | | | | | | | | | | | | | | | | | | | | | | | | |
| Total | 198.0 | | | | | | | | | | | | | | | | | | | | | | | | | | | | | | | | | | |

| | | | | | | | | | | | | | | | | | | | | | | | |
|---------------------|--|----|-----|---|----|-------|---|----|------|---|----|------|---|----|------|---|----|-------|---|-------|------|-------|-----|
| <p>Prøve</p> | <table style="width:100%; border-collapse: collapse;"> <tr><td style="width:10%;">1:</td><td style="width:40%;">9.6</td><td style="width:50%; text-align: right;">↗</td></tr> <tr><td>2:</td><td>*10.6</td><td style="text-align: right;">→</td></tr> <tr><td>3:</td><td>10.1</td><td style="text-align: right;">↘</td></tr> <tr><td>4:</td><td>10.0</td><td style="text-align: right;">↘</td></tr> <tr><td>5:</td><td>10.2</td><td style="text-align: right;">←</td></tr> <tr><td>6:</td><td>*10.7</td><td style="text-align: right;">↓</td></tr> </table> <table border="1" style="width:100%; border-collapse: collapse; margin-top: 5px;"> <tr> <td style="width:80%;">Serie</td> <td style="width:20%; text-align: right;">59.0</td> </tr> <tr> <td>Total</td> <td style="text-align: right;">0.0</td> </tr> </table> | 1: | 9.6 | ↗ | 2: | *10.6 | → | 3: | 10.1 | ↘ | 4: | 10.0 | ↘ | 5: | 10.2 | ← | 6: | *10.7 | ↓ | Serie | 59.0 | Total | 0.0 |
| 1: | 9.6 | ↗ | | | | | | | | | | | | | | | | | | | | | |
| 2: | *10.6 | → | | | | | | | | | | | | | | | | | | | | | |
| 3: | 10.1 | ↘ | | | | | | | | | | | | | | | | | | | | | |
| 4: | 10.0 | ↘ | | | | | | | | | | | | | | | | | | | | | |
| 5: | 10.2 | ← | | | | | | | | | | | | | | | | | | | | | |
| 6: | *10.7 | ↓ | | | | | | | | | | | | | | | | | | | | | |
| Serie | 59.0 | | | | | | | | | | | | | | | | | | | | | | |
| Total | 0.0 | | | | | | | | | | | | | | | | | | | | | | |

| | | | | | | | | | | | | | | | | | | | | | | | | | | | | | | | | | | | |
|-----------------------|--|----|-------|---|----|------|---|----|-------|---|----|------|---|----|------|---|----|------|---|----|-------|---|----|-------|---|----|------|---|-----|-------|---|-------|-------|-------|-------|
| <p>20 Skud</p> | <table style="width:100%; border-collapse: collapse;"> <tr><td style="width:10%;">1:</td><td style="width:40%;">*10.7</td><td style="width:50%; text-align: right;">↗</td></tr> <tr><td>2:</td><td>10.0</td><td style="text-align: right;">↓</td></tr> <tr><td>3:</td><td>*10.6</td><td style="text-align: right;">↘</td></tr> <tr><td>4:</td><td>10.0</td><td style="text-align: right;">↗</td></tr> <tr><td>5:</td><td>10.2</td><td style="text-align: right;">↘</td></tr> <tr><td>6:</td><td>10.2</td><td style="text-align: right;">←</td></tr> <tr><td>7:</td><td>*10.6</td><td style="text-align: right;">→</td></tr> <tr><td>8:</td><td>*10.9</td><td style="text-align: right;">↗</td></tr> <tr><td>9:</td><td>10.5</td><td style="text-align: right;">↘</td></tr> <tr><td>10:</td><td>*10.8</td><td style="text-align: right;">↓</td></tr> </table> <table border="1" style="width:100%; border-collapse: collapse; margin-top: 5px;"> <tr> <td style="width:80%;">Serie</td> <td style="width:20%; text-align: right;">100.0</td> </tr> <tr> <td>Total</td> <td style="text-align: right;">100.0</td> </tr> </table> | 1: | *10.7 | ↗ | 2: | 10.0 | ↓ | 3: | *10.6 | ↘ | 4: | 10.0 | ↗ | 5: | 10.2 | ↘ | 6: | 10.2 | ← | 7: | *10.6 | → | 8: | *10.9 | ↗ | 9: | 10.5 | ↘ | 10: | *10.8 | ↓ | Serie | 100.0 | Total | 100.0 |
| 1: | *10.7 | ↗ | | | | | | | | | | | | | | | | | | | | | | | | | | | | | | | | | |
| 2: | 10.0 | ↓ | | | | | | | | | | | | | | | | | | | | | | | | | | | | | | | | | |
| 3: | *10.6 | ↘ | | | | | | | | | | | | | | | | | | | | | | | | | | | | | | | | | |
| 4: | 10.0 | ↗ | | | | | | | | | | | | | | | | | | | | | | | | | | | | | | | | | |
| 5: | 10.2 | ↘ | | | | | | | | | | | | | | | | | | | | | | | | | | | | | | | | | |
| 6: | 10.2 | ← | | | | | | | | | | | | | | | | | | | | | | | | | | | | | | | | | |
| 7: | *10.6 | → | | | | | | | | | | | | | | | | | | | | | | | | | | | | | | | | | |
| 8: | *10.9 | ↗ | | | | | | | | | | | | | | | | | | | | | | | | | | | | | | | | | |
| 9: | 10.5 | ↘ | | | | | | | | | | | | | | | | | | | | | | | | | | | | | | | | | |
| 10: | *10.8 | ↓ | | | | | | | | | | | | | | | | | | | | | | | | | | | | | | | | | |
| Serie | 100.0 | | | | | | | | | | | | | | | | | | | | | | | | | | | | | | | | | | |
| Total | 100.0 | | | | | | | | | | | | | | | | | | | | | | | | | | | | | | | | | | |

| | | | | | | | | | | | | | | | | | | | | | | | | | | | | | | | | | | | |
|-----------------------|---|-----|-------|---|-----|-------|---|-----|-------|---|-----|-------|---|-----|-------|---|-----|------|---|-----|-------|---|-----|------|---|-----|-------|---|-----|------|---|-------|-------|-------|-------|
| <p>20 Skud</p> | <table style="width:100%; border-collapse: collapse;"> <tr><td style="width:10%;">11:</td><td style="width:40%;">*10.6</td><td style="width:50%; text-align: right;">↗</td></tr> <tr><td>12:</td><td>*10.6</td><td style="text-align: right;">↘</td></tr> <tr><td>13:</td><td>*10.7</td><td style="text-align: right;">↘</td></tr> <tr><td>14:</td><td>*10.8</td><td style="text-align: right;">←</td></tr> <tr><td>15:</td><td>*10.7</td><td style="text-align: right;">↓</td></tr> <tr><td>16:</td><td>10.5</td><td style="text-align: right;">↓</td></tr> <tr><td>17:</td><td>*10.7</td><td style="text-align: right;">↗</td></tr> <tr><td>18:</td><td>10.5</td><td style="text-align: right;">↘</td></tr> <tr><td>19:</td><td>*10.5</td><td style="text-align: right;">↘</td></tr> <tr><td>20:</td><td>10.4</td><td style="text-align: right;">↓</td></tr> </table> <table border="1" style="width:100%; border-collapse: collapse; margin-top: 5px;"> <tr> <td style="width:80%;">Serie</td> <td style="width:20%; text-align: right;">100.0</td> </tr> <tr> <td>Total</td> <td style="text-align: right;">200.0</td> </tr> </table> | 11: | *10.6 | ↗ | 12: | *10.6 | ↘ | 13: | *10.7 | ↘ | 14: | *10.8 | ← | 15: | *10.7 | ↓ | 16: | 10.5 | ↓ | 17: | *10.7 | ↗ | 18: | 10.5 | ↘ | 19: | *10.5 | ↘ | 20: | 10.4 | ↓ | Serie | 100.0 | Total | 200.0 |
| 11: | *10.6 | ↗ | | | | | | | | | | | | | | | | | | | | | | | | | | | | | | | | | |
| 12: | *10.6 | ↘ | | | | | | | | | | | | | | | | | | | | | | | | | | | | | | | | | |
| 13: | *10.7 | ↘ | | | | | | | | | | | | | | | | | | | | | | | | | | | | | | | | | |
| 14: | *10.8 | ← | | | | | | | | | | | | | | | | | | | | | | | | | | | | | | | | | |
| 15: | *10.7 | ↓ | | | | | | | | | | | | | | | | | | | | | | | | | | | | | | | | | |
| 16: | 10.5 | ↓ | | | | | | | | | | | | | | | | | | | | | | | | | | | | | | | | | |
| 17: | *10.7 | ↗ | | | | | | | | | | | | | | | | | | | | | | | | | | | | | | | | | |
| 18: | 10.5 | ↘ | | | | | | | | | | | | | | | | | | | | | | | | | | | | | | | | | |
| 19: | *10.5 | ↘ | | | | | | | | | | | | | | | | | | | | | | | | | | | | | | | | | |
| 20: | 10.4 | ↓ | | | | | | | | | | | | | | | | | | | | | | | | | | | | | | | | | |
| Serie | 100.0 | | | | | | | | | | | | | | | | | | | | | | | | | | | | | | | | | | |
| Total | 200.0 | | | | | | | | | | | | | | | | | | | | | | | | | | | | | | | | | | |

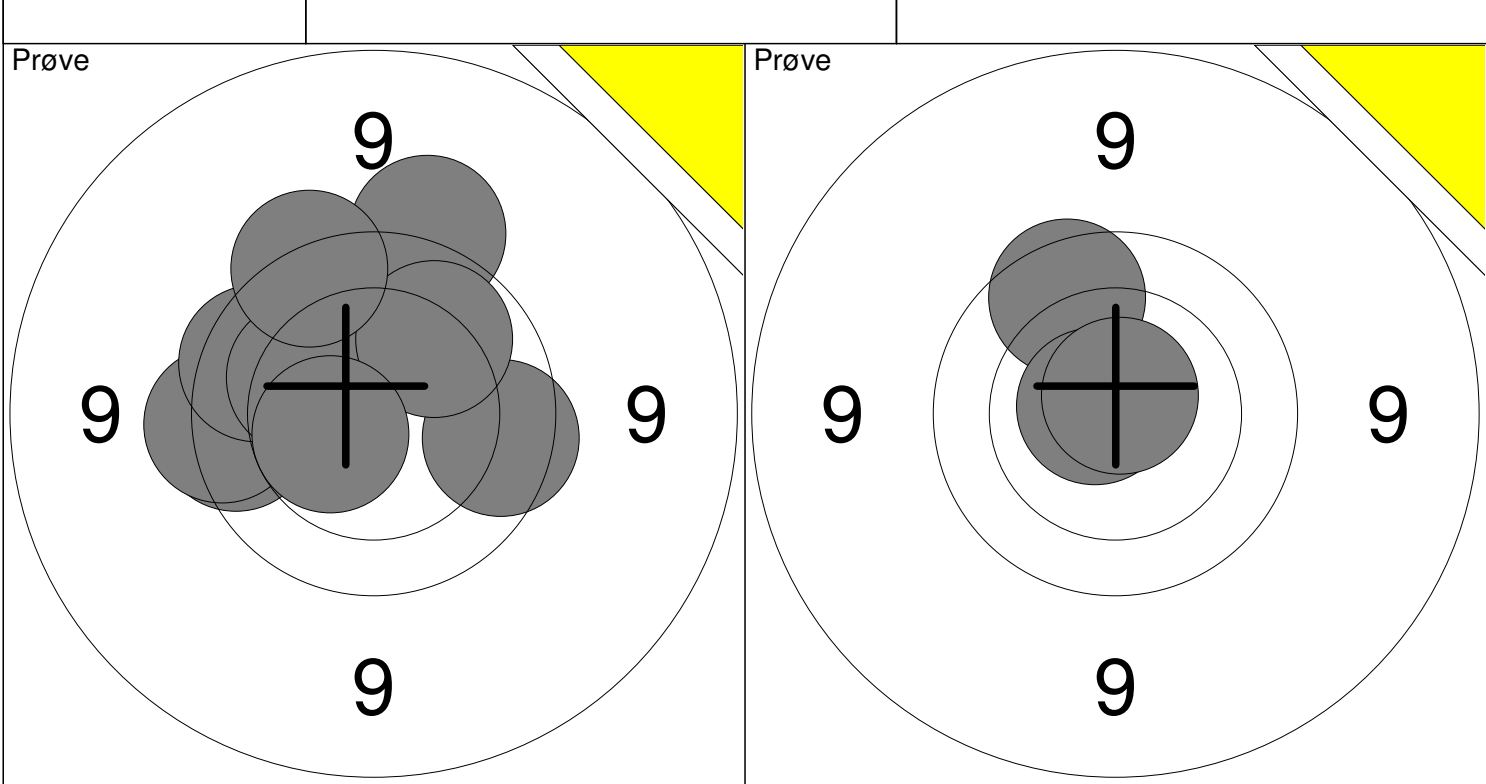

| | | | | | | |
|-----------|------------|-------|------|-------------|-------|------|
| 1: 10.0 ↑ | 6: 9.8 → | Serie | 94.0 | 11: 9.8 ↑ | Serie | 29.0 |
| 2: 9.8 ← | 7: 9.5 ↑ | | | 12: *10.7 ← | | |
| 3: 9.7 ← | 8: 10.0 ↗ | Total | 0.0 | 13: *10.8 ↑ | Total | 0.0 |
| 4: 9.8 ↖ | 9: *10.5 ← | | | 10: 9.6 ↑ | | |

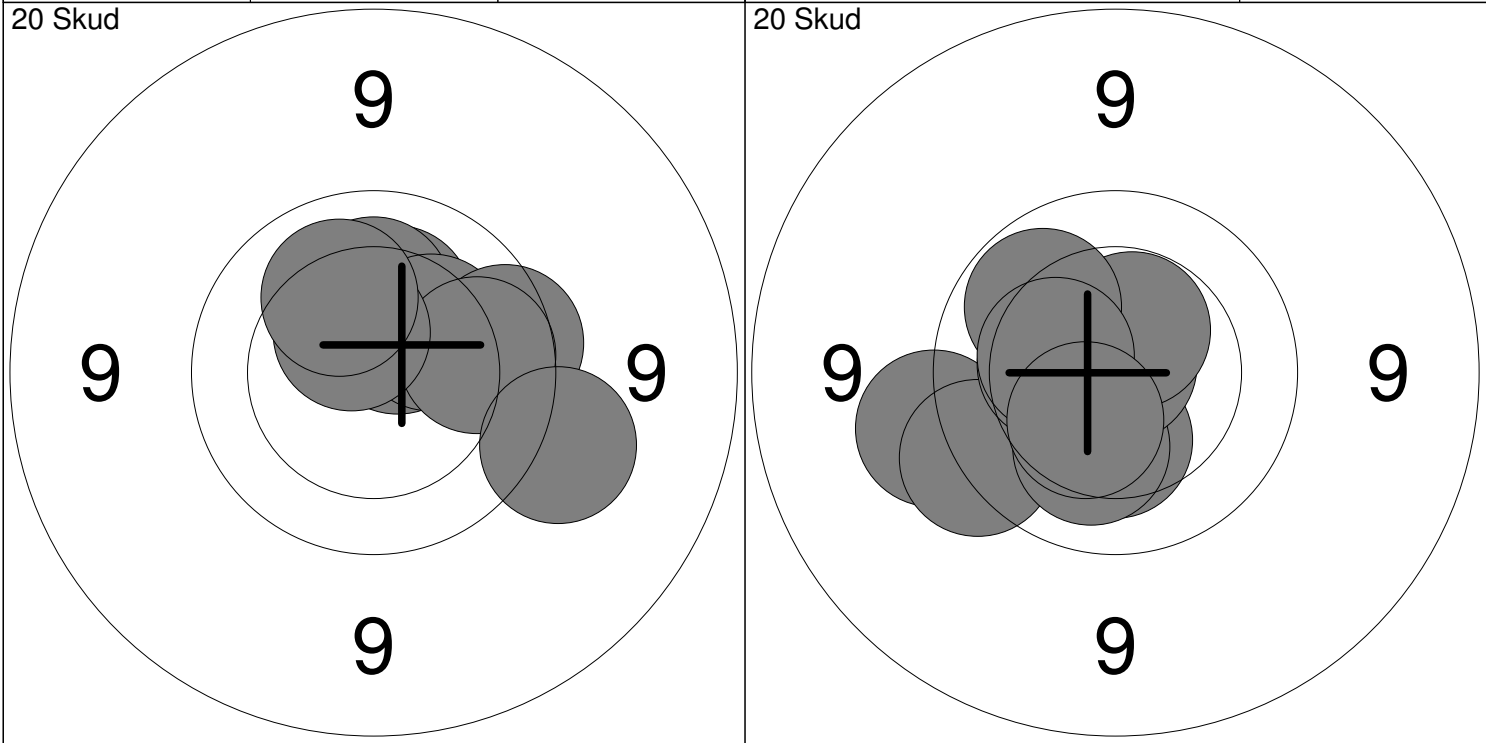

| | | | | | | | |
|------------|------------|-------------|------------|------------|-------------|-------|-------|
| 1: 10.3 ↑ | 6: 9.8 → | Serie | 97.0 | 11: 10.3 ↓ | 16: 10.4 ← | Serie | 98.0 |
| 2: *10.5 ↗ | 7: 9.9 → | | | 12: 9.5 ← | 17: *10.5 ↑ | | |
| 3: 10.3 ↑ | 8: *10.5 ↗ | Total | 97.0 | 13: 9.6 ↖ | 18: 10.0 ↖ | Total | 195.0 |
| 4: 10.2 ↑ | 9: 10.2 ↗ | | | 14: 10.2 ↓ | 19: 10.4 ← | | |
| 5: 10.3 ↗ | 10: 9.4 → | 15: *10.9 ↑ | 20: 10.4 ↓ | | | | |

| | | | | | | | | | | | | | | | | | | | | | | | | | | | | | | | | | | | | | | | | | | | | | | | | | | | | | |
|-----------------------|--|-------|-------|-------|---|--|-----|------|---|--|-----|------|---|-------|-----|------|------|-------|-----|------|-----|--|-----|-------|---|--|-----|------|---|--|-----|------|---|--|-----|-------|---|--|-----|-------|---|--|--|--|--|-------|--|--|-------|-------|--|--|-------|
| <p>Prøve</p> | <table style="width:100%; border-collapse: collapse;"> <tr> <td style="width:10%;"></td> <td style="width:10%;">1:</td> <td style="width:10%;">*10.8</td> <td style="width:10%; text-align: right;">↗</td> </tr> <tr> <td></td> <td>2:</td> <td>10.6</td> <td style="text-align: right;">↗</td> </tr> <tr> <td colspan="4" style="border-top: 1px solid black;"></td> </tr> <tr> <td colspan="3">Serie</td> <td style="text-align: right;">20.0</td> </tr> <tr> <td colspan="3">Total</td> <td style="text-align: right;">0.0</td> </tr> </table> | | 1: | *10.8 | ↗ | | 2: | 10.6 | ↗ | | | | | Serie | | | 20.0 | Total | | | 0.0 | | | | | | | | | | | | | | | | | | | | | | | | | | | | | | | | |
| | 1: | *10.8 | ↗ | | | | | | | | | | | | | | | | | | | | | | | | | | | | | | | | | | | | | | | | | | | | | | | | | | |
| | 2: | 10.6 | ↗ | | | | | | | | | | | | | | | | | | | | | | | | | | | | | | | | | | | | | | | | | | | | | | | | | | |
| | | | | | | | | | | | | | | | | | | | | | | | | | | | | | | | | | | | | | | | | | | | | | | | | | | | | | |
| Serie | | | 20.0 | | | | | | | | | | | | | | | | | | | | | | | | | | | | | | | | | | | | | | | | | | | | | | | | | | |
| Total | | | 0.0 | | | | | | | | | | | | | | | | | | | | | | | | | | | | | | | | | | | | | | | | | | | | | | | | | | |
| <p>20 Skud</p> | <table style="width:100%; border-collapse: collapse;"> <tr> <td style="width:10%;"></td> <td style="width:10%;">1:</td> <td style="width:10%;">10.5</td> <td style="width:10%; text-align: right;">↗</td> </tr> <tr> <td></td> <td>2:</td> <td>10.1</td> <td style="text-align: right;">↖</td> </tr> <tr> <td></td> <td>3:</td> <td>10.5</td> <td style="text-align: right;">↗</td> </tr> <tr> <td></td> <td>4:</td> <td>10.4</td> <td style="text-align: right;">↗</td> </tr> <tr> <td></td> <td>5:</td> <td>9.8</td> <td style="text-align: right;">↗</td> </tr> <tr> <td></td> <td>6:</td> <td>10.3</td> <td style="text-align: right;">↗</td> </tr> <tr> <td></td> <td>7:</td> <td>10.4</td> <td style="text-align: right;">↖</td> </tr> <tr> <td></td> <td>8:</td> <td>10.5</td> <td style="text-align: right;">↖</td> </tr> <tr> <td></td> <td>9:</td> <td>*10.7</td> <td style="text-align: right;">↘</td> </tr> <tr> <td></td> <td>10:</td> <td>10.2</td> <td style="text-align: right;">→</td> </tr> <tr> <td colspan="4" style="border-top: 1px solid black;"></td> </tr> <tr> <td colspan="3">Serie</td> <td style="text-align: right;">99.0</td> </tr> <tr> <td colspan="3">Total</td> <td style="text-align: right;">99.0</td> </tr> </table> | | 1: | 10.5 | ↗ | | 2: | 10.1 | ↖ | | 3: | 10.5 | ↗ | | 4: | 10.4 | ↗ | | 5: | 9.8 | ↗ | | 6: | 10.3 | ↗ | | 7: | 10.4 | ↖ | | 8: | 10.5 | ↖ | | 9: | *10.7 | ↘ | | 10: | 10.2 | → | | | | | Serie | | | 99.0 | Total | | | 99.0 |
| | 1: | 10.5 | ↗ | | | | | | | | | | | | | | | | | | | | | | | | | | | | | | | | | | | | | | | | | | | | | | | | | | |
| | 2: | 10.1 | ↖ | | | | | | | | | | | | | | | | | | | | | | | | | | | | | | | | | | | | | | | | | | | | | | | | | | |
| | 3: | 10.5 | ↗ | | | | | | | | | | | | | | | | | | | | | | | | | | | | | | | | | | | | | | | | | | | | | | | | | | |
| | 4: | 10.4 | ↗ | | | | | | | | | | | | | | | | | | | | | | | | | | | | | | | | | | | | | | | | | | | | | | | | | | |
| | 5: | 9.8 | ↗ | | | | | | | | | | | | | | | | | | | | | | | | | | | | | | | | | | | | | | | | | | | | | | | | | | |
| | 6: | 10.3 | ↗ | | | | | | | | | | | | | | | | | | | | | | | | | | | | | | | | | | | | | | | | | | | | | | | | | | |
| | 7: | 10.4 | ↖ | | | | | | | | | | | | | | | | | | | | | | | | | | | | | | | | | | | | | | | | | | | | | | | | | | |
| | 8: | 10.5 | ↖ | | | | | | | | | | | | | | | | | | | | | | | | | | | | | | | | | | | | | | | | | | | | | | | | | | |
| | 9: | *10.7 | ↘ | | | | | | | | | | | | | | | | | | | | | | | | | | | | | | | | | | | | | | | | | | | | | | | | | | |
| | 10: | 10.2 | → | | | | | | | | | | | | | | | | | | | | | | | | | | | | | | | | | | | | | | | | | | | | | | | | | | |
| | | | | | | | | | | | | | | | | | | | | | | | | | | | | | | | | | | | | | | | | | | | | | | | | | | | | | |
| Serie | | | 99.0 | | | | | | | | | | | | | | | | | | | | | | | | | | | | | | | | | | | | | | | | | | | | | | | | | | |
| Total | | | 99.0 | | | | | | | | | | | | | | | | | | | | | | | | | | | | | | | | | | | | | | | | | | | | | | | | | | |
| <p>20 Skud</p> | <table style="width:100%; border-collapse: collapse;"> <tr> <td style="width:10%;"></td> <td style="width:10%;">11:</td> <td style="width:10%;">*10.6</td> <td style="width:10%; text-align: right;">↘</td> </tr> <tr> <td></td> <td>12:</td> <td>10.3</td> <td style="text-align: right;">→</td> </tr> <tr> <td></td> <td>13:</td> <td>10.3</td> <td style="text-align: right;">↗</td> </tr> <tr> <td></td> <td>14:</td> <td>10.2</td> <td style="text-align: right;">↗</td> </tr> <tr> <td></td> <td>15:</td> <td>10.4</td> <td style="text-align: right;">↘</td> </tr> <tr> <td></td> <td>16:</td> <td>*10.8</td> <td style="text-align: right;">↘</td> </tr> <tr> <td></td> <td>17:</td> <td>10.5</td> <td style="text-align: right;">→</td> </tr> <tr> <td></td> <td>18:</td> <td>10.4</td> <td style="text-align: right;">→</td> </tr> <tr> <td></td> <td>19:</td> <td>10.5</td> <td style="text-align: right;">↘</td> </tr> <tr> <td></td> <td>20:</td> <td>*10.7</td> <td style="text-align: right;">↘</td> </tr> <tr> <td colspan="4" style="border-top: 1px solid black;"></td> </tr> <tr> <td colspan="3">Serie</td> <td style="text-align: right;">100.0</td> </tr> <tr> <td colspan="3">Total</td> <td style="text-align: right;">199.0</td> </tr> </table> | | 11: | *10.6 | ↘ | | 12: | 10.3 | → | | 13: | 10.3 | ↗ | | 14: | 10.2 | ↗ | | 15: | 10.4 | ↘ | | 16: | *10.8 | ↘ | | 17: | 10.5 | → | | 18: | 10.4 | → | | 19: | 10.5 | ↘ | | 20: | *10.7 | ↘ | | | | | Serie | | | 100.0 | Total | | | 199.0 |
| | 11: | *10.6 | ↘ | | | | | | | | | | | | | | | | | | | | | | | | | | | | | | | | | | | | | | | | | | | | | | | | | | |
| | 12: | 10.3 | → | | | | | | | | | | | | | | | | | | | | | | | | | | | | | | | | | | | | | | | | | | | | | | | | | | |
| | 13: | 10.3 | ↗ | | | | | | | | | | | | | | | | | | | | | | | | | | | | | | | | | | | | | | | | | | | | | | | | | | |
| | 14: | 10.2 | ↗ | | | | | | | | | | | | | | | | | | | | | | | | | | | | | | | | | | | | | | | | | | | | | | | | | | |
| | 15: | 10.4 | ↘ | | | | | | | | | | | | | | | | | | | | | | | | | | | | | | | | | | | | | | | | | | | | | | | | | | |
| | 16: | *10.8 | ↘ | | | | | | | | | | | | | | | | | | | | | | | | | | | | | | | | | | | | | | | | | | | | | | | | | | |
| | 17: | 10.5 | → | | | | | | | | | | | | | | | | | | | | | | | | | | | | | | | | | | | | | | | | | | | | | | | | | | |
| | 18: | 10.4 | → | | | | | | | | | | | | | | | | | | | | | | | | | | | | | | | | | | | | | | | | | | | | | | | | | | |
| | 19: | 10.5 | ↘ | | | | | | | | | | | | | | | | | | | | | | | | | | | | | | | | | | | | | | | | | | | | | | | | | | |
| | 20: | *10.7 | ↘ | | | | | | | | | | | | | | | | | | | | | | | | | | | | | | | | | | | | | | | | | | | | | | | | | | |
| | | | | | | | | | | | | | | | | | | | | | | | | | | | | | | | | | | | | | | | | | | | | | | | | | | | | | |
| Serie | | | 100.0 | | | | | | | | | | | | | | | | | | | | | | | | | | | | | | | | | | | | | | | | | | | | | | | | | | |
| Total | | | 199.0 | | | | | | | | | | | | | | | | | | | | | | | | | | | | | | | | | | | | | | | | | | | | | | | | | | |

Hold
5Skive
3**Arne Schiønning**

Aalborg Skyttekreds

MV2

Prøve

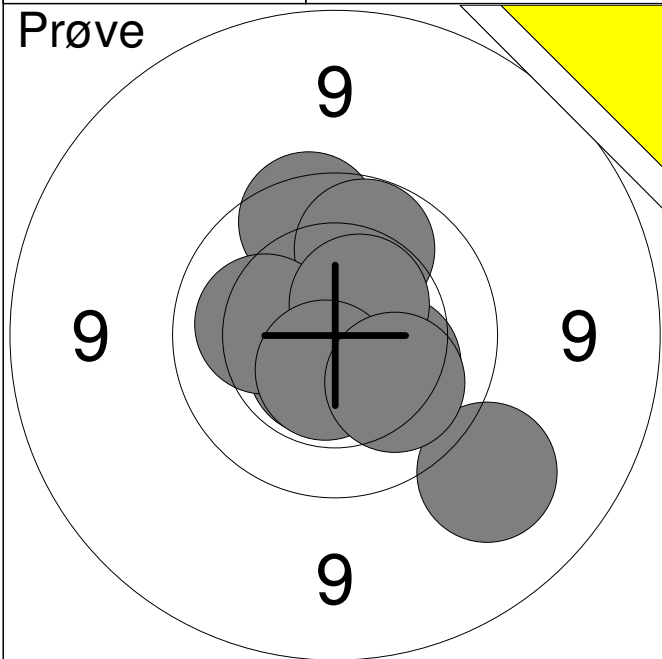

| | | |
|-----|-------|---|
| 1: | 9.3 | ↘ |
| 2: | 10.5 | ↘ |
| 3: | *10.6 | ↙ |
| 4: | 10.3 | ↘ |
| 5: | 9.8 | ↗ |
| 6: | 10.0 | ↗ |
| 7: | 10.2 | ↖ |
| 8: | *10.5 | ↗ |
| 9: | *10.6 | ↘ |
| 10: | 10.1 | ↘ |

Serie 98.0

Total 0.0

20 Skud

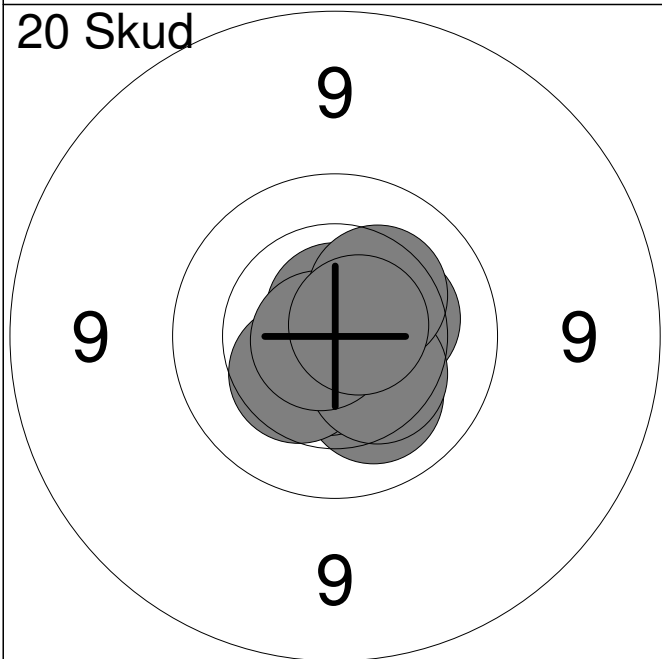

| | | |
|-----|-------|---|
| 1: | 10.2 | ↘ |
| 2: | *10.9 | ↗ |
| 3: | *10.6 | ↘ |
| 4: | 10.3 | → |
| 5: | 10.4 | ↙ |
| 6: | *10.7 | ↗ |
| 7: | 10.3 | ↘ |
| 8: | *10.8 | ↖ |
| 9: | 10.3 | ↗ |
| 10: | *10.7 | → |

Serie 100.0

Total 100.0

20 Skud

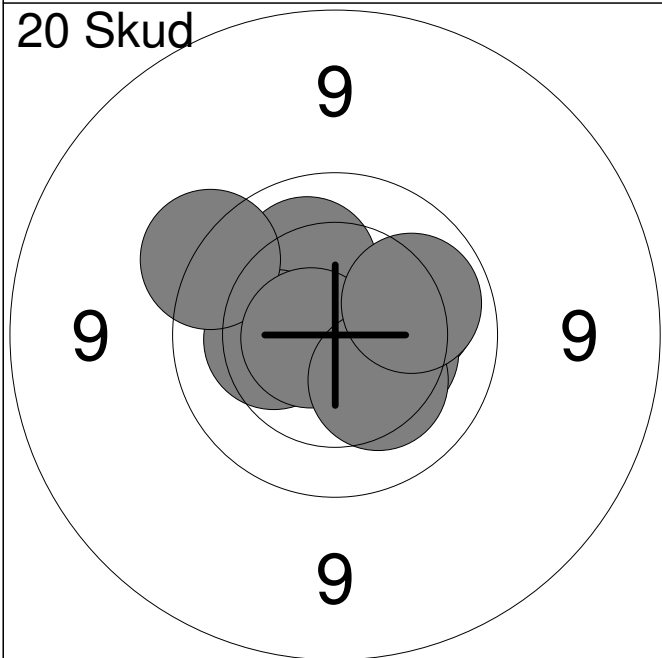

| | | |
|-----|-------|---|
| 11: | 10.1 | → |
| 12: | 10.3 | ↘ |
| 13: | 10.3 | ↗ |
| 14: | 10.2 | ↗ |
| 15: | 10.3 | ↖ |
| 16: | 9.6 | ↗ |
| 17: | *10.6 | ↘ |
| 18: | *10.7 | ↖ |
| 19: | 10.3 | ↘ |
| 20: | 10.1 | → |

Serie 99.0

Total 199.0

| | | | | | | | | | | | | | | | | | | | | | | | |
|---------------------|--|----|-----|---|----|-----|---|----|------|---|----|------|---|----|------|---|----|-------|---|-------|------|-------|-----|
| <p>Prøve</p> | <table style="width:100%; border-collapse: collapse;"> <tr><td style="text-align: right;">1:</td><td style="text-align: right;">9.8</td><td style="text-align: right;">↗</td></tr> <tr><td style="text-align: right;">2:</td><td style="text-align: right;">9.8</td><td style="text-align: right;">←</td></tr> <tr><td style="text-align: right;">3:</td><td style="text-align: right;">10.5</td><td style="text-align: right;">→</td></tr> <tr><td style="text-align: right;">4:</td><td style="text-align: right;">10.4</td><td style="text-align: right;">↘</td></tr> <tr><td style="text-align: right;">5:</td><td style="text-align: right;">10.3</td><td style="text-align: right;">↖</td></tr> <tr><td style="text-align: right;">6:</td><td style="text-align: right;">*10.6</td><td style="text-align: right;">←</td></tr> </table> <table border="1" style="width:100%; border-collapse: collapse; margin-top: 5px;"> <tr> <td style="width:80%;">Serie</td> <td style="text-align: right;">58.0</td> </tr> <tr> <td>Total</td> <td style="text-align: right;">0.0</td> </tr> </table> | 1: | 9.8 | ↗ | 2: | 9.8 | ← | 3: | 10.5 | → | 4: | 10.4 | ↘ | 5: | 10.3 | ↖ | 6: | *10.6 | ← | Serie | 58.0 | Total | 0.0 |
| 1: | 9.8 | ↗ | | | | | | | | | | | | | | | | | | | | | |
| 2: | 9.8 | ← | | | | | | | | | | | | | | | | | | | | | |
| 3: | 10.5 | → | | | | | | | | | | | | | | | | | | | | | |
| 4: | 10.4 | ↘ | | | | | | | | | | | | | | | | | | | | | |
| 5: | 10.3 | ↖ | | | | | | | | | | | | | | | | | | | | | |
| 6: | *10.6 | ← | | | | | | | | | | | | | | | | | | | | | |
| Serie | 58.0 | | | | | | | | | | | | | | | | | | | | | | |
| Total | 0.0 | | | | | | | | | | | | | | | | | | | | | | |

| | | | | | | | | | | | | | | | | | | | | | | | | | | | | | | | | | | | |
|-----------------------|---|----|-------|---|----|-------|---|----|-------|---|----|-------|---|----|------|---|----|-----|---|----|------|---|----|------|---|----|------|---|-----|-------|---|-------|------|-------|------|
| <p>20 Skud</p> | <table style="width:100%; border-collapse: collapse;"> <tr><td style="text-align: right;">1:</td><td style="text-align: right;">*10.6</td><td style="text-align: right;">↘</td></tr> <tr><td style="text-align: right;">2:</td><td style="text-align: right;">*10.7</td><td style="text-align: right;">↗</td></tr> <tr><td style="text-align: right;">3:</td><td style="text-align: right;">*10.8</td><td style="text-align: right;">↗</td></tr> <tr><td style="text-align: right;">4:</td><td style="text-align: right;">*10.7</td><td style="text-align: right;">↘</td></tr> <tr><td style="text-align: right;">5:</td><td style="text-align: right;">10.3</td><td style="text-align: right;">↖</td></tr> <tr><td style="text-align: right;">6:</td><td style="text-align: right;">9.6</td><td style="text-align: right;">↖</td></tr> <tr><td style="text-align: right;">7:</td><td style="text-align: right;">10.3</td><td style="text-align: right;">↘</td></tr> <tr><td style="text-align: right;">8:</td><td style="text-align: right;">10.5</td><td style="text-align: right;">↗</td></tr> <tr><td style="text-align: right;">9:</td><td style="text-align: right;">10.5</td><td style="text-align: right;">←</td></tr> <tr><td style="text-align: right;">10:</td><td style="text-align: right;">*10.9</td><td style="text-align: right;">↖</td></tr> </table> <table border="1" style="width:100%; border-collapse: collapse; margin-top: 5px;"> <tr> <td style="width:80%;">Serie</td> <td style="text-align: right;">99.0</td> </tr> <tr> <td>Total</td> <td style="text-align: right;">99.0</td> </tr> </table> | 1: | *10.6 | ↘ | 2: | *10.7 | ↗ | 3: | *10.8 | ↗ | 4: | *10.7 | ↘ | 5: | 10.3 | ↖ | 6: | 9.6 | ↖ | 7: | 10.3 | ↘ | 8: | 10.5 | ↗ | 9: | 10.5 | ← | 10: | *10.9 | ↖ | Serie | 99.0 | Total | 99.0 |
| 1: | *10.6 | ↘ | | | | | | | | | | | | | | | | | | | | | | | | | | | | | | | | | |
| 2: | *10.7 | ↗ | | | | | | | | | | | | | | | | | | | | | | | | | | | | | | | | | |
| 3: | *10.8 | ↗ | | | | | | | | | | | | | | | | | | | | | | | | | | | | | | | | | |
| 4: | *10.7 | ↘ | | | | | | | | | | | | | | | | | | | | | | | | | | | | | | | | | |
| 5: | 10.3 | ↖ | | | | | | | | | | | | | | | | | | | | | | | | | | | | | | | | | |
| 6: | 9.6 | ↖ | | | | | | | | | | | | | | | | | | | | | | | | | | | | | | | | | |
| 7: | 10.3 | ↘ | | | | | | | | | | | | | | | | | | | | | | | | | | | | | | | | | |
| 8: | 10.5 | ↗ | | | | | | | | | | | | | | | | | | | | | | | | | | | | | | | | | |
| 9: | 10.5 | ← | | | | | | | | | | | | | | | | | | | | | | | | | | | | | | | | | |
| 10: | *10.9 | ↖ | | | | | | | | | | | | | | | | | | | | | | | | | | | | | | | | | |
| Serie | 99.0 | | | | | | | | | | | | | | | | | | | | | | | | | | | | | | | | | | |
| Total | 99.0 | | | | | | | | | | | | | | | | | | | | | | | | | | | | | | | | | | |

| | | | | | | | | | | | | | | | | | | | | | | | | | | | | | | | | | | | |
|-----------------------|--|-----|------|---|-----|------|---|-----|-------|---|-----|-------|---|-----|------|---|-----|------|---|-----|------|---|-----|------|---|-----|-------|---|-----|-------|---|-------|-------|-------|-------|
| <p>20 Skud</p> | <table style="width:100%; border-collapse: collapse;"> <tr><td style="text-align: right;">11:</td><td style="text-align: right;">10.3</td><td style="text-align: right;">→</td></tr> <tr><td style="text-align: right;">12:</td><td style="text-align: right;">10.4</td><td style="text-align: right;">↗</td></tr> <tr><td style="text-align: right;">13:</td><td style="text-align: right;">*10.7</td><td style="text-align: right;">↘</td></tr> <tr><td style="text-align: right;">14:</td><td style="text-align: right;">*10.7</td><td style="text-align: right;">←</td></tr> <tr><td style="text-align: right;">15:</td><td style="text-align: right;">10.4</td><td style="text-align: right;">←</td></tr> <tr><td style="text-align: right;">16:</td><td style="text-align: right;">10.3</td><td style="text-align: right;">↗</td></tr> <tr><td style="text-align: right;">17:</td><td style="text-align: right;">10.3</td><td style="text-align: right;">←</td></tr> <tr><td style="text-align: right;">18:</td><td style="text-align: right;">10.1</td><td style="text-align: right;">↖</td></tr> <tr><td style="text-align: right;">19:</td><td style="text-align: right;">*10.7</td><td style="text-align: right;">←</td></tr> <tr><td style="text-align: right;">20:</td><td style="text-align: right;">*10.7</td><td style="text-align: right;">↘</td></tr> </table> <table border="1" style="width:100%; border-collapse: collapse; margin-top: 5px;"> <tr> <td style="width:80%;">Serie</td> <td style="text-align: right;">100.0</td> </tr> <tr> <td>Total</td> <td style="text-align: right;">199.0</td> </tr> </table> | 11: | 10.3 | → | 12: | 10.4 | ↗ | 13: | *10.7 | ↘ | 14: | *10.7 | ← | 15: | 10.4 | ← | 16: | 10.3 | ↗ | 17: | 10.3 | ← | 18: | 10.1 | ↖ | 19: | *10.7 | ← | 20: | *10.7 | ↘ | Serie | 100.0 | Total | 199.0 |
| 11: | 10.3 | → | | | | | | | | | | | | | | | | | | | | | | | | | | | | | | | | | |
| 12: | 10.4 | ↗ | | | | | | | | | | | | | | | | | | | | | | | | | | | | | | | | | |
| 13: | *10.7 | ↘ | | | | | | | | | | | | | | | | | | | | | | | | | | | | | | | | | |
| 14: | *10.7 | ← | | | | | | | | | | | | | | | | | | | | | | | | | | | | | | | | | |
| 15: | 10.4 | ← | | | | | | | | | | | | | | | | | | | | | | | | | | | | | | | | | |
| 16: | 10.3 | ↗ | | | | | | | | | | | | | | | | | | | | | | | | | | | | | | | | | |
| 17: | 10.3 | ← | | | | | | | | | | | | | | | | | | | | | | | | | | | | | | | | | |
| 18: | 10.1 | ↖ | | | | | | | | | | | | | | | | | | | | | | | | | | | | | | | | | |
| 19: | *10.7 | ← | | | | | | | | | | | | | | | | | | | | | | | | | | | | | | | | | |
| 20: | *10.7 | ↘ | | | | | | | | | | | | | | | | | | | | | | | | | | | | | | | | | |
| Serie | 100.0 | | | | | | | | | | | | | | | | | | | | | | | | | | | | | | | | | | |
| Total | 199.0 | | | | | | | | | | | | | | | | | | | | | | | | | | | | | | | | | | |

| | | | | | | | | | | | | | | | | | | | | |
|---------------------|--|----|-----|---|----|------|---|----|-----|---|----|-----|---|----|-------|---|-------|------|-------|-----|
| <p>Prøve</p> | <table style="width:100%; border-collapse: collapse;"> <tr><td style="text-align: right;">1:</td><td style="text-align: right;">9.3</td><td style="text-align: right;">→</td></tr> <tr><td style="text-align: right;">2:</td><td style="text-align: right;">10.4</td><td style="text-align: right;">↙</td></tr> <tr><td style="text-align: right;">3:</td><td style="text-align: right;">9.5</td><td style="text-align: right;">←</td></tr> <tr><td style="text-align: right;">4:</td><td style="text-align: right;">9.8</td><td style="text-align: right;">→</td></tr> <tr><td style="text-align: right;">5:</td><td style="text-align: right;">*10.6</td><td style="text-align: right;">↙</td></tr> </table> <hr/> <table style="width:100%; border-collapse: collapse;"> <tr> <td style="width:80%;">Serie</td> <td style="text-align: right;">47.0</td> </tr> <tr> <td>Total</td> <td style="text-align: right;">0.0</td> </tr> </table> | 1: | 9.3 | → | 2: | 10.4 | ↙ | 3: | 9.5 | ← | 4: | 9.8 | → | 5: | *10.6 | ↙ | Serie | 47.0 | Total | 0.0 |
| 1: | 9.3 | → | | | | | | | | | | | | | | | | | | |
| 2: | 10.4 | ↙ | | | | | | | | | | | | | | | | | | |
| 3: | 9.5 | ← | | | | | | | | | | | | | | | | | | |
| 4: | 9.8 | → | | | | | | | | | | | | | | | | | | |
| 5: | *10.6 | ↙ | | | | | | | | | | | | | | | | | | |
| Serie | 47.0 | | | | | | | | | | | | | | | | | | | |
| Total | 0.0 | | | | | | | | | | | | | | | | | | | |

| | | | | | | | | | | | | | | | | | | | | | | | | | | | | | | | | | | | |
|-----------------------|--|----|-------|---|----|-------|---|----|------|---|----|-----|---|----|------|---|----|-------|---|----|-------|---|----|-----|---|----|------|---|-----|-------|---|-------|------|-------|------|
| <p>20 Skud</p> | <table style="width:100%; border-collapse: collapse;"> <tr><td style="text-align: right;">1:</td><td style="text-align: right;">*10.6</td><td style="text-align: right;">↘</td></tr> <tr><td style="text-align: right;">2:</td><td style="text-align: right;">*10.8</td><td style="text-align: right;">←</td></tr> <tr><td style="text-align: right;">3:</td><td style="text-align: right;">10.1</td><td style="text-align: right;">↗</td></tr> <tr><td style="text-align: right;">4:</td><td style="text-align: right;">9.3</td><td style="text-align: right;">↘</td></tr> <tr><td style="text-align: right;">5:</td><td style="text-align: right;">10.0</td><td style="text-align: right;">↙</td></tr> <tr><td style="text-align: right;">6:</td><td style="text-align: right;">*10.6</td><td style="text-align: right;">↗</td></tr> <tr><td style="text-align: right;">7:</td><td style="text-align: right;">*10.5</td><td style="text-align: right;">↖</td></tr> <tr><td style="text-align: right;">8:</td><td style="text-align: right;">9.6</td><td style="text-align: right;">↗</td></tr> <tr><td style="text-align: right;">9:</td><td style="text-align: right;">10.4</td><td style="text-align: right;">↘</td></tr> <tr><td style="text-align: right;">10:</td><td style="text-align: right;">*10.5</td><td style="text-align: right;">↗</td></tr> </table> <hr/> <table style="width:100%; border-collapse: collapse;"> <tr> <td style="width:80%;">Serie</td> <td style="text-align: right;">98.0</td> </tr> <tr> <td>Total</td> <td style="text-align: right;">98.0</td> </tr> </table> | 1: | *10.6 | ↘ | 2: | *10.8 | ← | 3: | 10.1 | ↗ | 4: | 9.3 | ↘ | 5: | 10.0 | ↙ | 6: | *10.6 | ↗ | 7: | *10.5 | ↖ | 8: | 9.6 | ↗ | 9: | 10.4 | ↘ | 10: | *10.5 | ↗ | Serie | 98.0 | Total | 98.0 |
| 1: | *10.6 | ↘ | | | | | | | | | | | | | | | | | | | | | | | | | | | | | | | | | |
| 2: | *10.8 | ← | | | | | | | | | | | | | | | | | | | | | | | | | | | | | | | | | |
| 3: | 10.1 | ↗ | | | | | | | | | | | | | | | | | | | | | | | | | | | | | | | | | |
| 4: | 9.3 | ↘ | | | | | | | | | | | | | | | | | | | | | | | | | | | | | | | | | |
| 5: | 10.0 | ↙ | | | | | | | | | | | | | | | | | | | | | | | | | | | | | | | | | |
| 6: | *10.6 | ↗ | | | | | | | | | | | | | | | | | | | | | | | | | | | | | | | | | |
| 7: | *10.5 | ↖ | | | | | | | | | | | | | | | | | | | | | | | | | | | | | | | | | |
| 8: | 9.6 | ↗ | | | | | | | | | | | | | | | | | | | | | | | | | | | | | | | | | |
| 9: | 10.4 | ↘ | | | | | | | | | | | | | | | | | | | | | | | | | | | | | | | | | |
| 10: | *10.5 | ↗ | | | | | | | | | | | | | | | | | | | | | | | | | | | | | | | | | |
| Serie | 98.0 | | | | | | | | | | | | | | | | | | | | | | | | | | | | | | | | | | |
| Total | 98.0 | | | | | | | | | | | | | | | | | | | | | | | | | | | | | | | | | | |

| | | | | | | | | | | | | | | | | | | | | | | | | | | | | | | | | | | | |
|-----------------------|--|-----|-----|---|-----|-----|---|-----|------|---|-----|------|---|-----|-----|---|-----|-------|---|-----|------|---|-----|-----|---|-----|-----|---|-----|-------|---|-------|------|-------|-------|
| <p>20 Skud</p> | <table style="width:100%; border-collapse: collapse;"> <tr><td style="text-align: right;">11:</td><td style="text-align: right;">9.5</td><td style="text-align: right;">↘</td></tr> <tr><td style="text-align: right;">12:</td><td style="text-align: right;">9.7</td><td style="text-align: right;">↙</td></tr> <tr><td style="text-align: right;">13:</td><td style="text-align: right;">10.1</td><td style="text-align: right;">↙</td></tr> <tr><td style="text-align: right;">14:</td><td style="text-align: right;">10.2</td><td style="text-align: right;">↖</td></tr> <tr><td style="text-align: right;">15:</td><td style="text-align: right;">9.6</td><td style="text-align: right;">↗</td></tr> <tr><td style="text-align: right;">16:</td><td style="text-align: right;">*10.7</td><td style="text-align: right;">↗</td></tr> <tr><td style="text-align: right;">17:</td><td style="text-align: right;">10.4</td><td style="text-align: right;">↘</td></tr> <tr><td style="text-align: right;">18:</td><td style="text-align: right;">8.9</td><td style="text-align: right;">→</td></tr> <tr><td style="text-align: right;">19:</td><td style="text-align: right;">9.9</td><td style="text-align: right;">→</td></tr> <tr><td style="text-align: right;">20:</td><td style="text-align: right;">*10.7</td><td style="text-align: right;">↙</td></tr> </table> <hr/> <table style="width:100%; border-collapse: collapse;"> <tr> <td style="width:80%;">Serie</td> <td style="text-align: right;">94.0</td> </tr> <tr> <td>Total</td> <td style="text-align: right;">192.0</td> </tr> </table> | 11: | 9.5 | ↘ | 12: | 9.7 | ↙ | 13: | 10.1 | ↙ | 14: | 10.2 | ↖ | 15: | 9.6 | ↗ | 16: | *10.7 | ↗ | 17: | 10.4 | ↘ | 18: | 8.9 | → | 19: | 9.9 | → | 20: | *10.7 | ↙ | Serie | 94.0 | Total | 192.0 |
| 11: | 9.5 | ↘ | | | | | | | | | | | | | | | | | | | | | | | | | | | | | | | | | |
| 12: | 9.7 | ↙ | | | | | | | | | | | | | | | | | | | | | | | | | | | | | | | | | |
| 13: | 10.1 | ↙ | | | | | | | | | | | | | | | | | | | | | | | | | | | | | | | | | |
| 14: | 10.2 | ↖ | | | | | | | | | | | | | | | | | | | | | | | | | | | | | | | | | |
| 15: | 9.6 | ↗ | | | | | | | | | | | | | | | | | | | | | | | | | | | | | | | | | |
| 16: | *10.7 | ↗ | | | | | | | | | | | | | | | | | | | | | | | | | | | | | | | | | |
| 17: | 10.4 | ↘ | | | | | | | | | | | | | | | | | | | | | | | | | | | | | | | | | |
| 18: | 8.9 | → | | | | | | | | | | | | | | | | | | | | | | | | | | | | | | | | | |
| 19: | 9.9 | → | | | | | | | | | | | | | | | | | | | | | | | | | | | | | | | | | |
| 20: | *10.7 | ↙ | | | | | | | | | | | | | | | | | | | | | | | | | | | | | | | | | |
| Serie | 94.0 | | | | | | | | | | | | | | | | | | | | | | | | | | | | | | | | | | |
| Total | 192.0 | | | | | | | | | | | | | | | | | | | | | | | | | | | | | | | | | | |

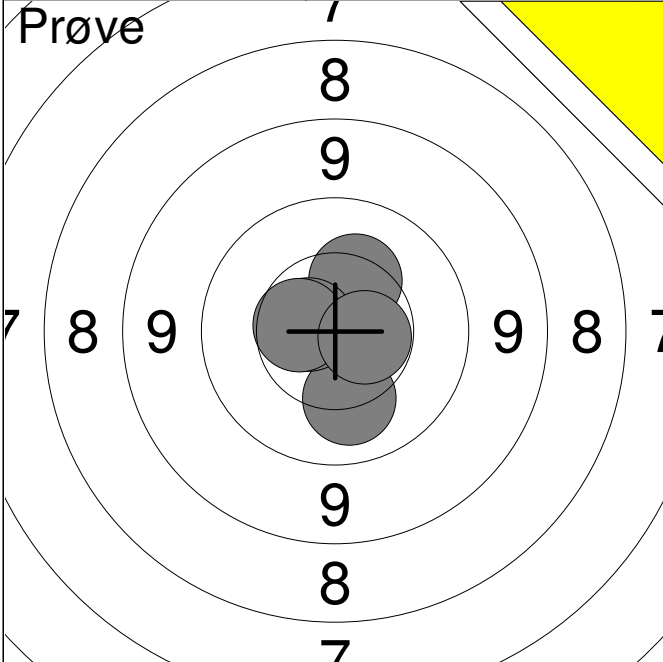
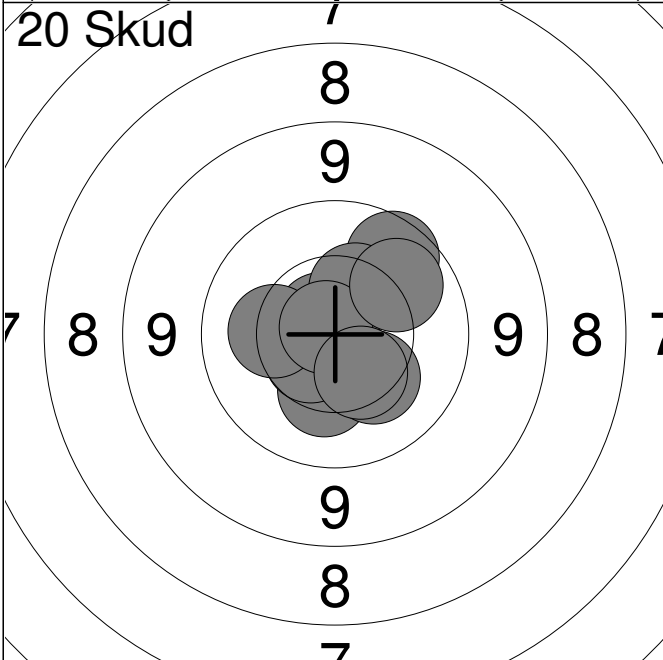
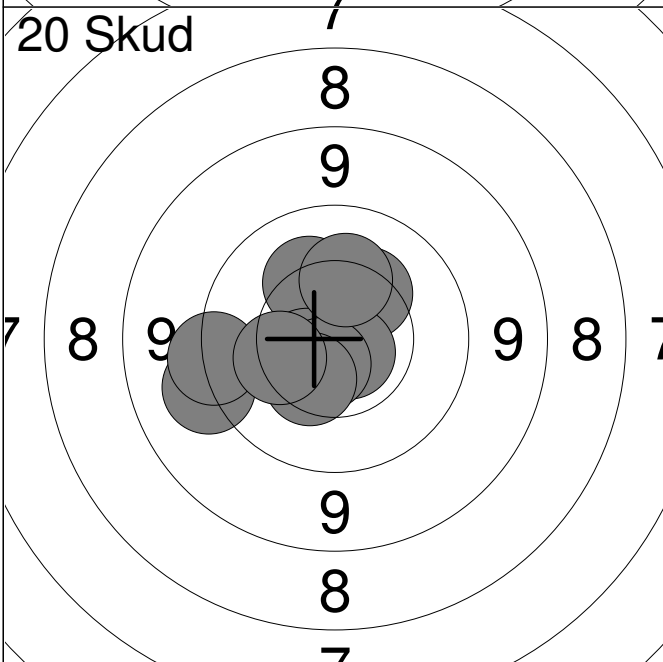
| | | | | | | | | | | | | | | | | | | | | | | | | | | | | | | | |
|---|--|-------|------|-------|-------|------|---|-----|-------|---|-----|-------|---|-----|-------|---|-----|------|---|-----|------|---|-----|-------|---|-----|------|---|-----|------|---|
| <p>Prøve</p>  | <table style="width:100%; border-collapse: collapse;"> <tr><td style="width:10%;">1:</td><td style="width:20%;">10.2</td><td style="width:10%; text-align: center;">↓</td></tr> <tr><td>2:</td><td>10.3</td><td style="text-align: center;">↑</td></tr> <tr><td>3:</td><td>*10.6</td><td style="text-align: center;">←</td></tr> <tr><td>4:</td><td>10.5</td><td style="text-align: center;">←</td></tr> <tr><td>5:</td><td>*10.6</td><td style="text-align: center;">→</td></tr> </table> | 1: | 10.2 | ↓ | 2: | 10.3 | ↑ | 3: | *10.6 | ← | 4: | 10.5 | ← | 5: | *10.6 | → | | | | | | | | | | | | | | | |
| 1: | 10.2 | ↓ | | | | | | | | | | | | | | | | | | | | | | | | | | | | | |
| 2: | 10.3 | ↑ | | | | | | | | | | | | | | | | | | | | | | | | | | | | | |
| 3: | *10.6 | ← | | | | | | | | | | | | | | | | | | | | | | | | | | | | | |
| 4: | 10.5 | ← | | | | | | | | | | | | | | | | | | | | | | | | | | | | | |
| 5: | *10.6 | → | | | | | | | | | | | | | | | | | | | | | | | | | | | | | |
| <table style="width:100%; border-collapse: collapse;"> <tr> <td style="width:45%; border-right: 1px solid black;">Serie</td> <td style="text-align: right;">50.0</td> </tr> <tr> <td style="border-right: 1px solid black;">Total</td> <td style="text-align: right;">0.0</td> </tr> </table> | | Serie | 50.0 | Total | 0.0 | | | | | | | | | | | | | | | | | | | | | | | | | | |
| Serie | 50.0 | | | | | | | | | | | | | | | | | | | | | | | | | | | | | | |
| Total | 0.0 | | | | | | | | | | | | | | | | | | | | | | | | | | | | | | |
| <p>20 Skud</p>  | <table style="width:100%; border-collapse: collapse;"> <tr><td style="width:10%;">1:</td><td style="width:20%;">9.8</td><td style="width:10%; text-align: center;">↗</td></tr> <tr><td>2:</td><td>10.3</td><td style="text-align: center;">↓</td></tr> <tr><td>3:</td><td>10.3</td><td style="text-align: center;">↓</td></tr> <tr><td>4:</td><td>10.6</td><td style="text-align: center;">←</td></tr> <tr><td>5:</td><td>*10.7</td><td style="text-align: center;">↗</td></tr> <tr><td>6:</td><td>10.4</td><td style="text-align: center;">↗</td></tr> <tr><td>7:</td><td>10.3</td><td style="text-align: center;">←</td></tr> <tr><td>8:</td><td>*10.8</td><td style="text-align: center;">↗</td></tr> <tr><td>9:</td><td>10.4</td><td style="text-align: center;">↓</td></tr> <tr><td>10:</td><td>10.0</td><td style="text-align: center;">↗</td></tr> </table> | 1: | 9.8 | ↗ | 2: | 10.3 | ↓ | 3: | 10.3 | ↓ | 4: | 10.6 | ← | 5: | *10.7 | ↗ | 6: | 10.4 | ↗ | 7: | 10.3 | ← | 8: | *10.8 | ↗ | 9: | 10.4 | ↓ | 10: | 10.0 | ↗ |
| 1: | 9.8 | ↗ | | | | | | | | | | | | | | | | | | | | | | | | | | | | | |
| 2: | 10.3 | ↓ | | | | | | | | | | | | | | | | | | | | | | | | | | | | | |
| 3: | 10.3 | ↓ | | | | | | | | | | | | | | | | | | | | | | | | | | | | | |
| 4: | 10.6 | ← | | | | | | | | | | | | | | | | | | | | | | | | | | | | | |
| 5: | *10.7 | ↗ | | | | | | | | | | | | | | | | | | | | | | | | | | | | | |
| 6: | 10.4 | ↗ | | | | | | | | | | | | | | | | | | | | | | | | | | | | | |
| 7: | 10.3 | ← | | | | | | | | | | | | | | | | | | | | | | | | | | | | | |
| 8: | *10.8 | ↗ | | | | | | | | | | | | | | | | | | | | | | | | | | | | | |
| 9: | 10.4 | ↓ | | | | | | | | | | | | | | | | | | | | | | | | | | | | | |
| 10: | 10.0 | ↗ | | | | | | | | | | | | | | | | | | | | | | | | | | | | | |
| <table style="width:100%; border-collapse: collapse;"> <tr> <td style="width:45%; border-right: 1px solid black;">Serie</td> <td style="text-align: right;">99.0</td> </tr> <tr> <td style="border-right: 1px solid black;">Total</td> <td style="text-align: right;">99.0</td> </tr> </table> | | Serie | 99.0 | Total | 99.0 | | | | | | | | | | | | | | | | | | | | | | | | | | |
| Serie | 99.0 | | | | | | | | | | | | | | | | | | | | | | | | | | | | | | |
| Total | 99.0 | | | | | | | | | | | | | | | | | | | | | | | | | | | | | | |
| <p>20 Skud</p>  | <table style="width:100%; border-collapse: collapse;"> <tr><td style="width:10%;">11:</td><td style="width:20%;">10.3</td><td style="width:10%; text-align: center;">↗</td></tr> <tr><td>12:</td><td>10.2</td><td style="text-align: center;">↗</td></tr> <tr><td>13:</td><td>10.6</td><td style="text-align: center;">←</td></tr> <tr><td>14:</td><td>*10.7</td><td style="text-align: center;">↓</td></tr> <tr><td>15:</td><td>*10.6</td><td style="text-align: center;">↓</td></tr> <tr><td>16:</td><td>10.3</td><td style="text-align: center;">↗</td></tr> <tr><td>17:</td><td>9.3</td><td style="text-align: center;">←</td></tr> <tr><td>18:</td><td>9.5</td><td style="text-align: center;">←</td></tr> <tr><td>19:</td><td>10.4</td><td style="text-align: center;">↓</td></tr> <tr><td>20:</td><td>10.3</td><td style="text-align: center;">←</td></tr> </table> | 11: | 10.3 | ↗ | 12: | 10.2 | ↗ | 13: | 10.6 | ← | 14: | *10.7 | ↓ | 15: | *10.6 | ↓ | 16: | 10.3 | ↗ | 17: | 9.3 | ← | 18: | 9.5 | ← | 19: | 10.4 | ↓ | 20: | 10.3 | ← |
| 11: | 10.3 | ↗ | | | | | | | | | | | | | | | | | | | | | | | | | | | | | |
| 12: | 10.2 | ↗ | | | | | | | | | | | | | | | | | | | | | | | | | | | | | |
| 13: | 10.6 | ← | | | | | | | | | | | | | | | | | | | | | | | | | | | | | |
| 14: | *10.7 | ↓ | | | | | | | | | | | | | | | | | | | | | | | | | | | | | |
| 15: | *10.6 | ↓ | | | | | | | | | | | | | | | | | | | | | | | | | | | | | |
| 16: | 10.3 | ↗ | | | | | | | | | | | | | | | | | | | | | | | | | | | | | |
| 17: | 9.3 | ← | | | | | | | | | | | | | | | | | | | | | | | | | | | | | |
| 18: | 9.5 | ← | | | | | | | | | | | | | | | | | | | | | | | | | | | | | |
| 19: | 10.4 | ↓ | | | | | | | | | | | | | | | | | | | | | | | | | | | | | |
| 20: | 10.3 | ← | | | | | | | | | | | | | | | | | | | | | | | | | | | | | |
| <table style="width:100%; border-collapse: collapse;"> <tr> <td style="width:45%; border-right: 1px solid black;">Serie</td> <td style="text-align: right;">98.0</td> </tr> <tr> <td style="border-right: 1px solid black;">Total</td> <td style="text-align: right;">197.0</td> </tr> </table> | | Serie | 98.0 | Total | 197.0 | | | | | | | | | | | | | | | | | | | | | | | | | | |
| Serie | 98.0 | | | | | | | | | | | | | | | | | | | | | | | | | | | | | | |
| Total | 197.0 | | | | | | | | | | | | | | | | | | | | | | | | | | | | | | |

Hold

5

Skive

7

Mike R. M. Jensen

Hobro Egnens Skytteforening

MB1

Prøve

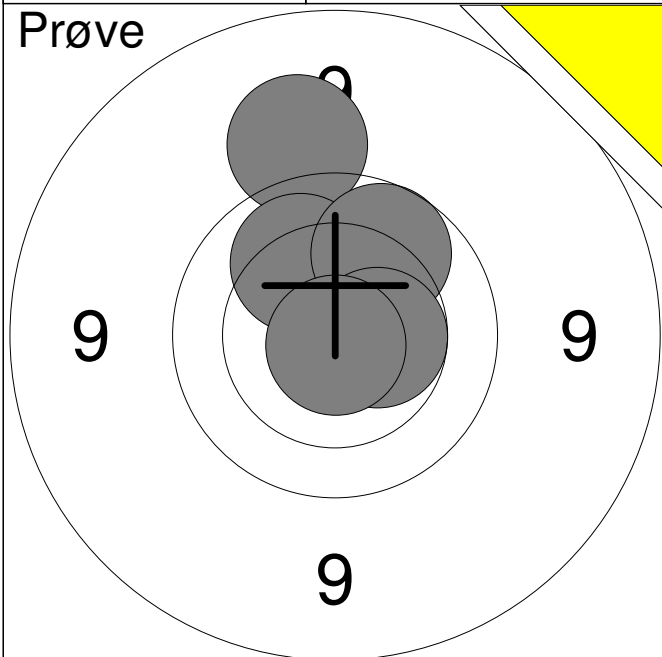

| | |
|----|-------|
| 1: | 9.3 |
| 2: | 10.1 |
| 3: | 9.9 |
| 4: | *10.5 |
| 5: | *10.8 |



Serie 48.0

Total 0.0

20 Skud

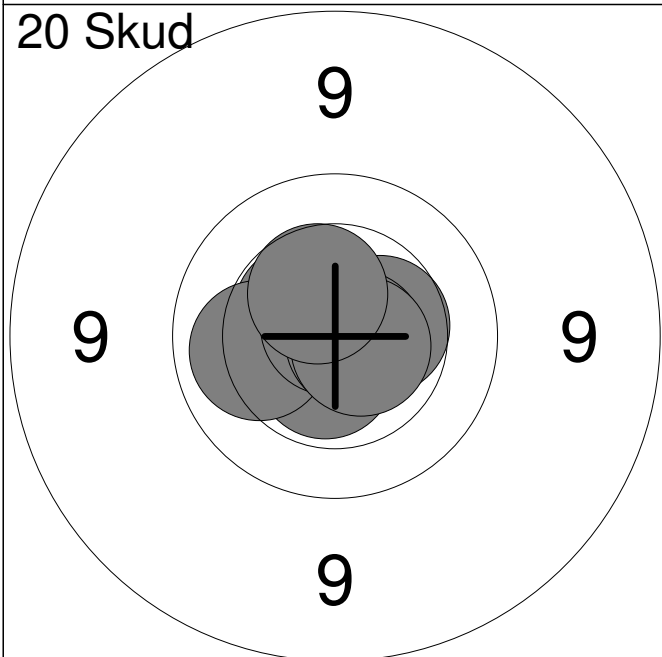

| | |
|-----|-------|
| 1: | *10.6 |
| 2: | *10.9 |
| 3: | *10.6 |
| 4: | *10.5 |
| 5: | 10.1 |
| 6: | 10.5 |
| 7: | *10.8 |
| 8: | *10.7 |
| 9: | *10.7 |
| 10: | 10.5 |

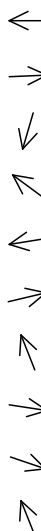

Serie 100.0

Total 100.0

20 Skud

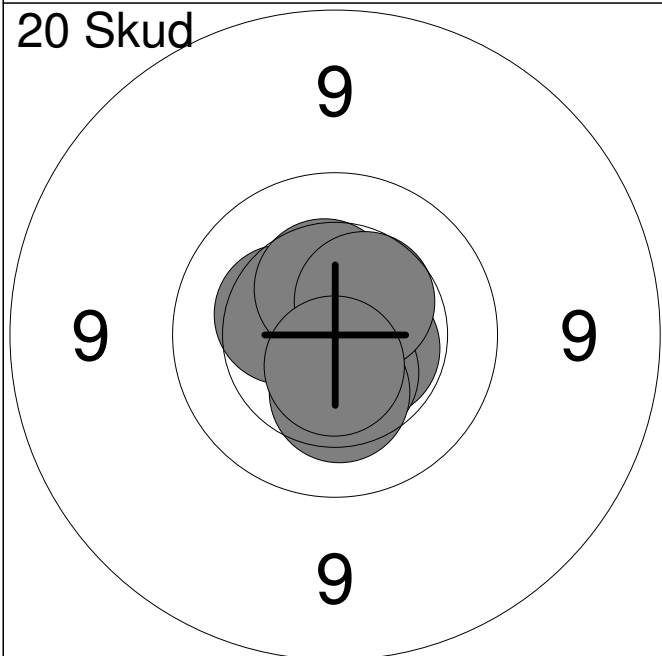

| | |
|-----|-------|
| 11: | *10.6 |
| 12: | *10.8 |
| 13: | 10.4 |
| 14: | *10.7 |
| 15: | *10.5 |
| 16: | *10.5 |
| 17: | 10.3 |
| 18: | 10.4 |
| 19: | 10.5 |
| 20: | *10.6 |



Serie 100.0

Total 200.0

| | | | | | | | | | | | | | | | | | | | | |
|---------------------|--|----|-----|---|----|-------|---|----|-------|---|----|------|---|----|-------|---|-------|------|-------|-----|
| <p>Prøve</p> | <table style="width:100%; border-collapse: collapse;"> <tr><td style="text-align: right;">1:</td><td style="text-align: right;">9.7</td><td style="text-align: right;">↗</td></tr> <tr><td style="text-align: right;">2:</td><td style="text-align: right;">*10.5</td><td style="text-align: right;">↑</td></tr> <tr><td style="text-align: right;">3:</td><td style="text-align: right;">*10.8</td><td style="text-align: right;">↗</td></tr> <tr><td style="text-align: right;">4:</td><td style="text-align: right;">10.4</td><td style="text-align: right;">→</td></tr> <tr><td style="text-align: right;">5:</td><td style="text-align: right;">*10.5</td><td style="text-align: right;">↙</td></tr> </table> <hr/> <table style="width:100%; border-collapse: collapse;"> <tr> <td style="width:80%;">Serie</td> <td style="text-align: right;">49.0</td> </tr> <tr> <td>Total</td> <td style="text-align: right;">0.0</td> </tr> </table> | 1: | 9.7 | ↗ | 2: | *10.5 | ↑ | 3: | *10.8 | ↗ | 4: | 10.4 | → | 5: | *10.5 | ↙ | Serie | 49.0 | Total | 0.0 |
| 1: | 9.7 | ↗ | | | | | | | | | | | | | | | | | | |
| 2: | *10.5 | ↑ | | | | | | | | | | | | | | | | | | |
| 3: | *10.8 | ↗ | | | | | | | | | | | | | | | | | | |
| 4: | 10.4 | → | | | | | | | | | | | | | | | | | | |
| 5: | *10.5 | ↙ | | | | | | | | | | | | | | | | | | |
| Serie | 49.0 | | | | | | | | | | | | | | | | | | | |
| Total | 0.0 | | | | | | | | | | | | | | | | | | | |

| | | | | | | | | | | | | | | | | | | | | | | | | | | | | | | | | | | | |
|-----------------------|--|----|------|---|----|------|---|----|------|---|----|------|---|----|-------|---|----|------|---|----|-----|---|----|-------|---|----|-------|---|-----|-------|---|-------|------|-------|------|
| <p>20 Skud</p> | <table style="width:100%; border-collapse: collapse;"> <tr><td style="text-align: right;">1:</td><td style="text-align: right;">10.4</td><td style="text-align: right;">↑</td></tr> <tr><td style="text-align: right;">2:</td><td style="text-align: right;">10.4</td><td style="text-align: right;">↓</td></tr> <tr><td style="text-align: right;">3:</td><td style="text-align: right;">10.1</td><td style="text-align: right;">↑</td></tr> <tr><td style="text-align: right;">4:</td><td style="text-align: right;">10.4</td><td style="text-align: right;">←</td></tr> <tr><td style="text-align: right;">5:</td><td style="text-align: right;">*10.7</td><td style="text-align: right;">↙</td></tr> <tr><td style="text-align: right;">6:</td><td style="text-align: right;">10.4</td><td style="text-align: right;">↑</td></tr> <tr><td style="text-align: right;">7:</td><td style="text-align: right;">9.8</td><td style="text-align: right;">↗</td></tr> <tr><td style="text-align: right;">8:</td><td style="text-align: right;">*10.7</td><td style="text-align: right;">↙</td></tr> <tr><td style="text-align: right;">9:</td><td style="text-align: right;">*10.7</td><td style="text-align: right;">↑</td></tr> <tr><td style="text-align: right;">10:</td><td style="text-align: right;">*10.8</td><td style="text-align: right;">←</td></tr> </table> <hr/> <table style="width:100%; border-collapse: collapse;"> <tr> <td style="width:80%;">Serie</td> <td style="text-align: right;">99.0</td> </tr> <tr> <td>Total</td> <td style="text-align: right;">99.0</td> </tr> </table> | 1: | 10.4 | ↑ | 2: | 10.4 | ↓ | 3: | 10.1 | ↑ | 4: | 10.4 | ← | 5: | *10.7 | ↙ | 6: | 10.4 | ↑ | 7: | 9.8 | ↗ | 8: | *10.7 | ↙ | 9: | *10.7 | ↑ | 10: | *10.8 | ← | Serie | 99.0 | Total | 99.0 |
| 1: | 10.4 | ↑ | | | | | | | | | | | | | | | | | | | | | | | | | | | | | | | | | |
| 2: | 10.4 | ↓ | | | | | | | | | | | | | | | | | | | | | | | | | | | | | | | | | |
| 3: | 10.1 | ↑ | | | | | | | | | | | | | | | | | | | | | | | | | | | | | | | | | |
| 4: | 10.4 | ← | | | | | | | | | | | | | | | | | | | | | | | | | | | | | | | | | |
| 5: | *10.7 | ↙ | | | | | | | | | | | | | | | | | | | | | | | | | | | | | | | | | |
| 6: | 10.4 | ↑ | | | | | | | | | | | | | | | | | | | | | | | | | | | | | | | | | |
| 7: | 9.8 | ↗ | | | | | | | | | | | | | | | | | | | | | | | | | | | | | | | | | |
| 8: | *10.7 | ↙ | | | | | | | | | | | | | | | | | | | | | | | | | | | | | | | | | |
| 9: | *10.7 | ↑ | | | | | | | | | | | | | | | | | | | | | | | | | | | | | | | | | |
| 10: | *10.8 | ← | | | | | | | | | | | | | | | | | | | | | | | | | | | | | | | | | |
| Serie | 99.0 | | | | | | | | | | | | | | | | | | | | | | | | | | | | | | | | | | |
| Total | 99.0 | | | | | | | | | | | | | | | | | | | | | | | | | | | | | | | | | | |

| | | | | | | | | | | | | | | | | | | | | | | | | | | | | | | | | | | | |
|-----------------------|--|-----|------|---|-----|-------|---|-----|-----|---|-----|------|---|-----|------|---|-----|-------|---|-----|------|---|-----|------|---|-----|-------|---|-----|-------|---|-------|------|-------|-------|
| <p>20 Skud</p> | <table style="width:100%; border-collapse: collapse;"> <tr><td style="text-align: right;">11:</td><td style="text-align: right;">10.3</td><td style="text-align: right;">↖</td></tr> <tr><td style="text-align: right;">12:</td><td style="text-align: right;">*10.5</td><td style="text-align: right;">↑</td></tr> <tr><td style="text-align: right;">13:</td><td style="text-align: right;">9.8</td><td style="text-align: right;">↑</td></tr> <tr><td style="text-align: right;">14:</td><td style="text-align: right;">10.4</td><td style="text-align: right;">→</td></tr> <tr><td style="text-align: right;">15:</td><td style="text-align: right;">10.5</td><td style="text-align: right;">↖</td></tr> <tr><td style="text-align: right;">16:</td><td style="text-align: right;">*10.7</td><td style="text-align: right;">↑</td></tr> <tr><td style="text-align: right;">17:</td><td style="text-align: right;">10.2</td><td style="text-align: right;">↖</td></tr> <tr><td style="text-align: right;">18:</td><td style="text-align: right;">10.3</td><td style="text-align: right;">↑</td></tr> <tr><td style="text-align: right;">19:</td><td style="text-align: right;">*10.6</td><td style="text-align: right;">→</td></tr> <tr><td style="text-align: right;">20:</td><td style="text-align: right;">*10.7</td><td style="text-align: right;">↓</td></tr> </table> <hr/> <table style="width:100%; border-collapse: collapse;"> <tr> <td style="width:80%;">Serie</td> <td style="text-align: right;">99.0</td> </tr> <tr> <td>Total</td> <td style="text-align: right;">198.0</td> </tr> </table> | 11: | 10.3 | ↖ | 12: | *10.5 | ↑ | 13: | 9.8 | ↑ | 14: | 10.4 | → | 15: | 10.5 | ↖ | 16: | *10.7 | ↑ | 17: | 10.2 | ↖ | 18: | 10.3 | ↑ | 19: | *10.6 | → | 20: | *10.7 | ↓ | Serie | 99.0 | Total | 198.0 |
| 11: | 10.3 | ↖ | | | | | | | | | | | | | | | | | | | | | | | | | | | | | | | | | |
| 12: | *10.5 | ↑ | | | | | | | | | | | | | | | | | | | | | | | | | | | | | | | | | |
| 13: | 9.8 | ↑ | | | | | | | | | | | | | | | | | | | | | | | | | | | | | | | | | |
| 14: | 10.4 | → | | | | | | | | | | | | | | | | | | | | | | | | | | | | | | | | | |
| 15: | 10.5 | ↖ | | | | | | | | | | | | | | | | | | | | | | | | | | | | | | | | | |
| 16: | *10.7 | ↑ | | | | | | | | | | | | | | | | | | | | | | | | | | | | | | | | | |
| 17: | 10.2 | ↖ | | | | | | | | | | | | | | | | | | | | | | | | | | | | | | | | | |
| 18: | 10.3 | ↑ | | | | | | | | | | | | | | | | | | | | | | | | | | | | | | | | | |
| 19: | *10.6 | → | | | | | | | | | | | | | | | | | | | | | | | | | | | | | | | | | |
| 20: | *10.7 | ↓ | | | | | | | | | | | | | | | | | | | | | | | | | | | | | | | | | |
| Serie | 99.0 | | | | | | | | | | | | | | | | | | | | | | | | | | | | | | | | | | |
| Total | 198.0 | | | | | | | | | | | | | | | | | | | | | | | | | | | | | | | | | | |

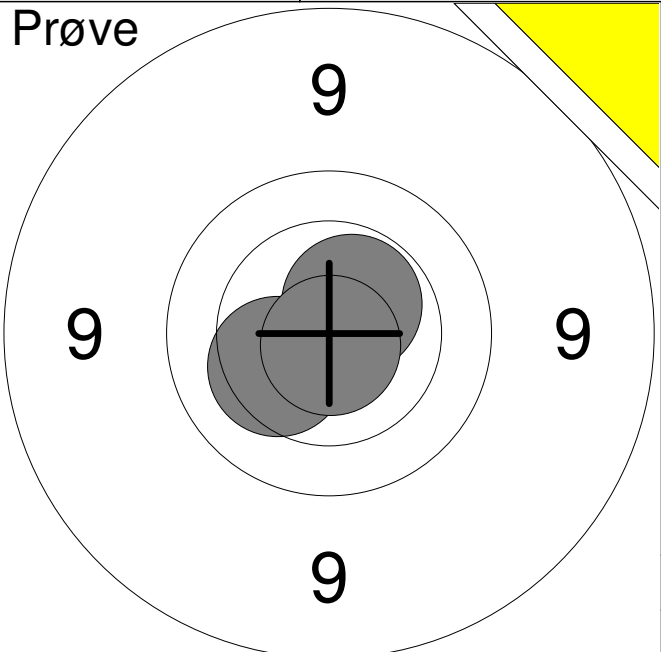
| | | | | | | | | | | |
|---|---|-------|------|------|-------|-------|-----|----|-------|---|
| <p>Prøve</p>  | <table style="width:100%; border-collapse: collapse;"> <tr><td style="width:10%;">1:</td><td style="width:15%;">10.3</td><td style="width:10%; text-align: right;">↙</td></tr> <tr><td>2:</td><td>*10.6</td><td style="text-align: right;">↗</td></tr> <tr><td>3:</td><td>*10.8</td><td style="text-align: right;">↓</td></tr> </table> | 1: | 10.3 | ↙ | 2: | *10.6 | ↗ | 3: | *10.8 | ↓ |
| 1: | 10.3 | ↙ | | | | | | | | |
| 2: | *10.6 | ↗ | | | | | | | | |
| 3: | *10.8 | ↓ | | | | | | | | |
| <table style="width:100%; border-collapse: collapse;"> <tr> <td style="width:10%;">Serie</td> <td style="width:80%;"></td> <td style="width:10%; text-align: right;">30.0</td> </tr> <tr> <td>Total</td> <td></td> <td style="text-align: right;">0.0</td> </tr> </table> | | Serie | | 30.0 | Total | | 0.0 | | | |
| Serie | | 30.0 | | | | | | | | |
| Total | | 0.0 | | | | | | | | |

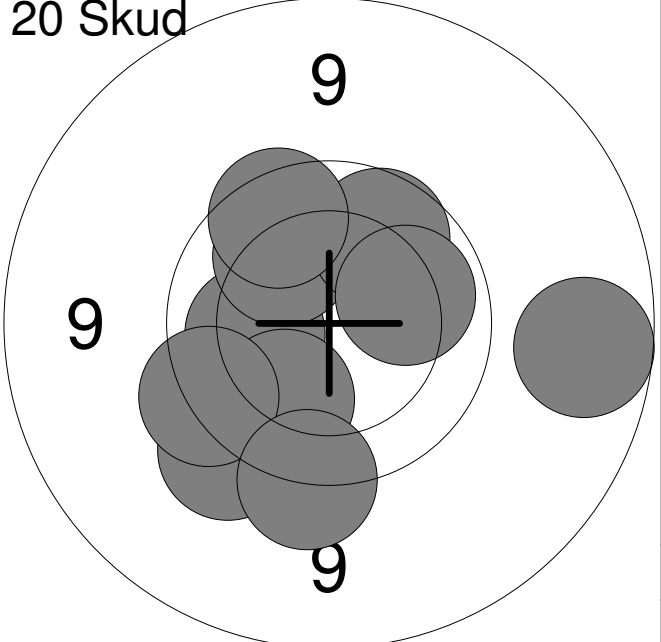
| | | | | | | | | | | | | | | | | | | | | | | | | | | | | | | | |
|--|---|-------|-----|------|-------|------|------|----|------|---|----|-----|---|----|------|---|----|-----|---|----|-----|---|----|------|---|----|-----|---|-----|-----|---|
| <p>20 Skud</p>  | <table style="width:100%; border-collapse: collapse;"> <tr><td style="width:10%;">1:</td><td style="width:15%;">9.5</td><td style="width:10%; text-align: right;">↙</td></tr> <tr><td>2:</td><td>10.1</td><td style="text-align: right;">←</td></tr> <tr><td>3:</td><td>10.0</td><td style="text-align: right;">↙</td></tr> <tr><td>4:</td><td>9.7</td><td style="text-align: right;">↙</td></tr> <tr><td>5:</td><td>10.1</td><td style="text-align: right;">↗</td></tr> <tr><td>6:</td><td>9.9</td><td style="text-align: right;">↗</td></tr> <tr><td>7:</td><td>9.8</td><td style="text-align: right;">↗</td></tr> <tr><td>8:</td><td>10.1</td><td style="text-align: right;">→</td></tr> <tr><td>9:</td><td>8.9</td><td style="text-align: right;">→</td></tr> <tr><td>10:</td><td>9.5</td><td style="text-align: right;">↓</td></tr> </table> | 1: | 9.5 | ↙ | 2: | 10.1 | ← | 3: | 10.0 | ↙ | 4: | 9.7 | ↙ | 5: | 10.1 | ↗ | 6: | 9.9 | ↗ | 7: | 9.8 | ↗ | 8: | 10.1 | → | 9: | 8.9 | → | 10: | 9.5 | ↓ |
| 1: | 9.5 | ↙ | | | | | | | | | | | | | | | | | | | | | | | | | | | | | |
| 2: | 10.1 | ← | | | | | | | | | | | | | | | | | | | | | | | | | | | | | |
| 3: | 10.0 | ↙ | | | | | | | | | | | | | | | | | | | | | | | | | | | | | |
| 4: | 9.7 | ↙ | | | | | | | | | | | | | | | | | | | | | | | | | | | | | |
| 5: | 10.1 | ↗ | | | | | | | | | | | | | | | | | | | | | | | | | | | | | |
| 6: | 9.9 | ↗ | | | | | | | | | | | | | | | | | | | | | | | | | | | | | |
| 7: | 9.8 | ↗ | | | | | | | | | | | | | | | | | | | | | | | | | | | | | |
| 8: | 10.1 | → | | | | | | | | | | | | | | | | | | | | | | | | | | | | | |
| 9: | 8.9 | → | | | | | | | | | | | | | | | | | | | | | | | | | | | | | |
| 10: | 9.5 | ↓ | | | | | | | | | | | | | | | | | | | | | | | | | | | | | |
| <table style="width:100%; border-collapse: collapse;"> <tr> <td style="width:10%;">Serie</td> <td style="width:80%;"></td> <td style="width:10%; text-align: right;">93.0</td> </tr> <tr> <td>Total</td> <td></td> <td style="text-align: right;">93.0</td> </tr> </table> | | Serie | | 93.0 | Total | | 93.0 | | | | | | | | | | | | | | | | | | | | | | | | |
| Serie | | 93.0 | | | | | | | | | | | | | | | | | | | | | | | | | | | | | |
| Total | | 93.0 | | | | | | | | | | | | | | | | | | | | | | | | | | | | | |

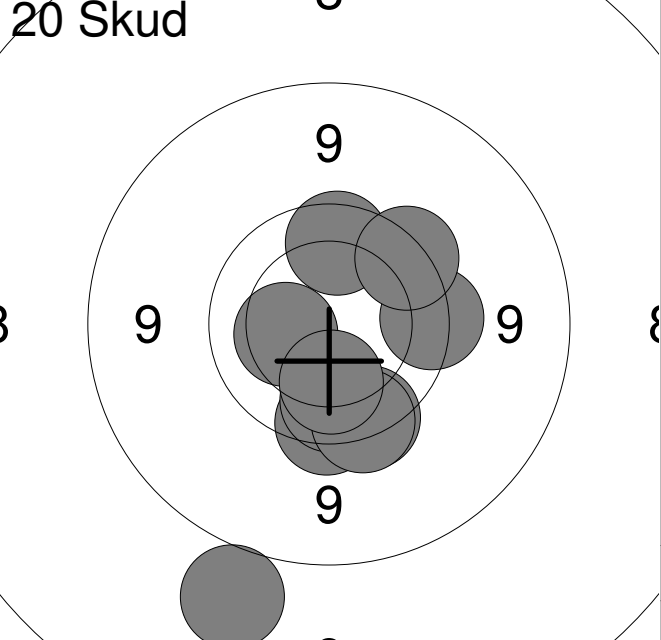
| | | | | | | | | | | | | | | | | | | | | | | | | | | | | | | | |
|---|--|-------|-----|------|-------|-----|-------|-----|-----|---|-----|-----|---|-----|-----|---|-----|-----|---|-----|------|---|-----|-----|---|-----|------|---|-----|-----|---|
| <p>20 Skud</p>  | <table style="width:100%; border-collapse: collapse;"> <tr><td style="width:10%;">11:</td><td style="width:15%;">9.7</td><td style="width:10%; text-align: right;">→</td></tr> <tr><td>12:</td><td>9.7</td><td style="text-align: right;">↓</td></tr> <tr><td>13:</td><td>9.8</td><td style="text-align: right;">↑</td></tr> <tr><td>14:</td><td>9.7</td><td style="text-align: right;">↙</td></tr> <tr><td>15:</td><td>9.7</td><td style="text-align: right;">↗</td></tr> <tr><td>16:</td><td>9.9</td><td style="text-align: right;">↓</td></tr> <tr><td>17:</td><td>10.3</td><td style="text-align: right;">←</td></tr> <tr><td>18:</td><td>9.7</td><td style="text-align: right;">↙</td></tr> <tr><td>19:</td><td>10.1</td><td style="text-align: right;">↓</td></tr> <tr><td>20:</td><td>8.4</td><td style="text-align: right;">↙</td></tr> </table> | 11: | 9.7 | → | 12: | 9.7 | ↓ | 13: | 9.8 | ↑ | 14: | 9.7 | ↙ | 15: | 9.7 | ↗ | 16: | 9.9 | ↓ | 17: | 10.3 | ← | 18: | 9.7 | ↙ | 19: | 10.1 | ↓ | 20: | 8.4 | ↙ |
| 11: | 9.7 | → | | | | | | | | | | | | | | | | | | | | | | | | | | | | | |
| 12: | 9.7 | ↓ | | | | | | | | | | | | | | | | | | | | | | | | | | | | | |
| 13: | 9.8 | ↑ | | | | | | | | | | | | | | | | | | | | | | | | | | | | | |
| 14: | 9.7 | ↙ | | | | | | | | | | | | | | | | | | | | | | | | | | | | | |
| 15: | 9.7 | ↗ | | | | | | | | | | | | | | | | | | | | | | | | | | | | | |
| 16: | 9.9 | ↓ | | | | | | | | | | | | | | | | | | | | | | | | | | | | | |
| 17: | 10.3 | ← | | | | | | | | | | | | | | | | | | | | | | | | | | | | | |
| 18: | 9.7 | ↙ | | | | | | | | | | | | | | | | | | | | | | | | | | | | | |
| 19: | 10.1 | ↓ | | | | | | | | | | | | | | | | | | | | | | | | | | | | | |
| 20: | 8.4 | ↙ | | | | | | | | | | | | | | | | | | | | | | | | | | | | | |
| <table style="width:100%; border-collapse: collapse;"> <tr> <td style="width:10%;">Serie</td> <td style="width:80%;"></td> <td style="width:10%; text-align: right;">91.0</td> </tr> <tr> <td>Total</td> <td></td> <td style="text-align: right;">184.0</td> </tr> </table> | | Serie | | 91.0 | Total | | 184.0 | | | | | | | | | | | | | | | | | | | | | | | | |
| Serie | | 91.0 | | | | | | | | | | | | | | | | | | | | | | | | | | | | | |
| Total | | 184.0 | | | | | | | | | | | | | | | | | | | | | | | | | | | | | |

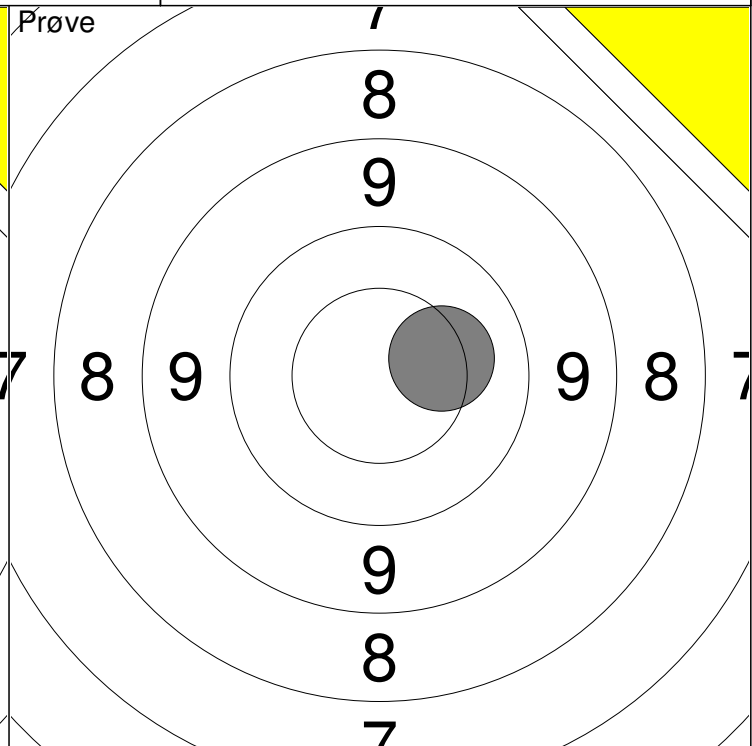
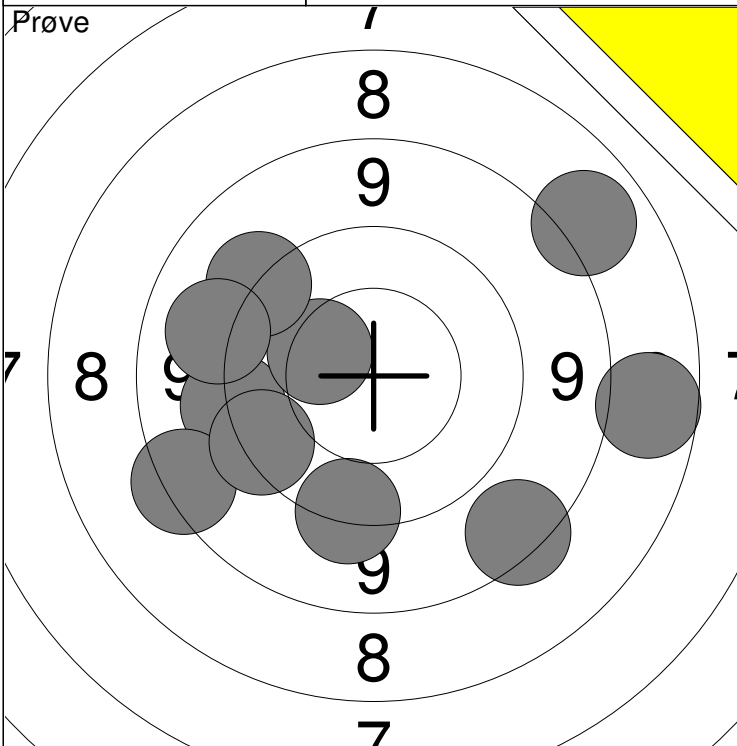

| | | | |
|----------|-----------|-------|------|
| 1: 7.9 → | 6: 10.3 ↖ | Serie | 86.0 |
| 2: 8.6 ↘ | 7: 9.4 ↗ | | |
| 3: 9.4 ← | 8: 9.5 ↘ | Total | 0.0 |
| 4: 8.1 ↗ | 9: 9.6 ↖ | | |
| 5: 8.6 ↙ | 10: 9.2 ↖ | | |

| | | |
|------------|-------|------|
| 11: 10.3 → | Serie | 10.0 |
| | | |
| | Total | 0.0 |
| | | |

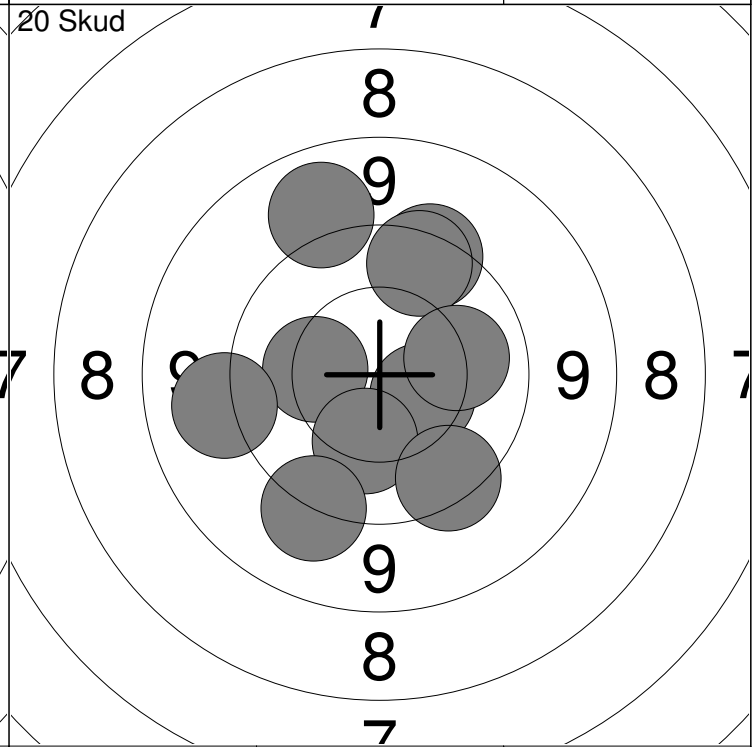
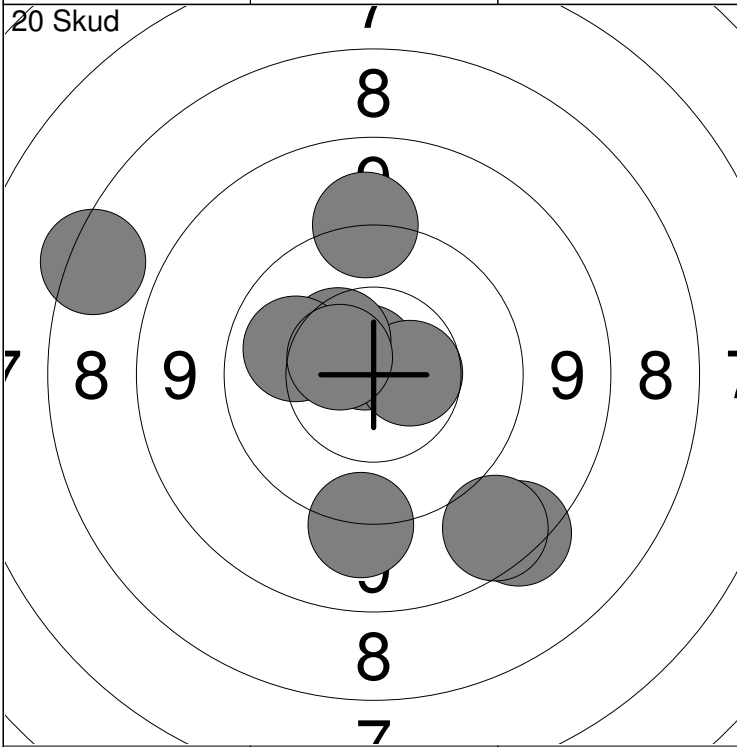

| | | | |
|------------|------------|-------|------|
| 1: *10.8 ↗ | 6: 10.4 ↗ | Serie | 91.0 |
| 2: 8.6 ↘ | 7: 10.1 ↖ | | |
| 3: 9.3 ↘ | 8: 9.4 ↗ | Total | 91.0 |
| 4: 8.8 ↘ | 9: 7.6 ↖ | | |
| 5: 10.6 → | 10: 10.6 ↖ | | |

| | | | |
|------------|------------|-------|-------|
| 11: 9.6 ↗ | 16: 9.1 ↗ | Serie | 94.0 |
| 12: 9.7 ↗ | 17: 10.2 ↘ | | |
| 13: 10.5 ↘ | 18: 9.3 ← | Total | 185.0 |
| 14: 10.3 ← | 19: 9.4 ↘ | | |
| 15: 10.1 → | 20: 9.6 ↘ | | |

Hold
5Skive
11**Brian Jensen**

Hobro Egnens Skytteforening

MÅ1

Prøve

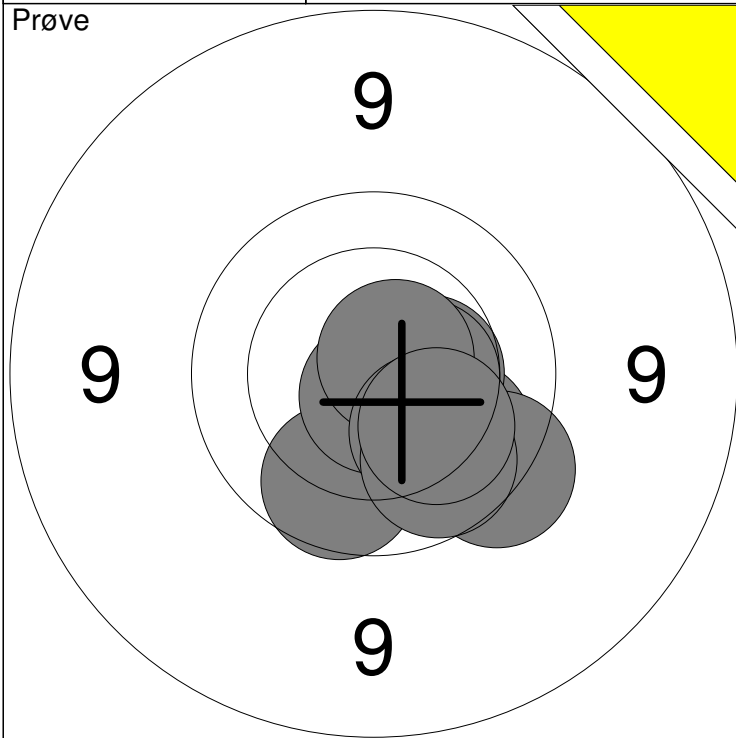

Prøve

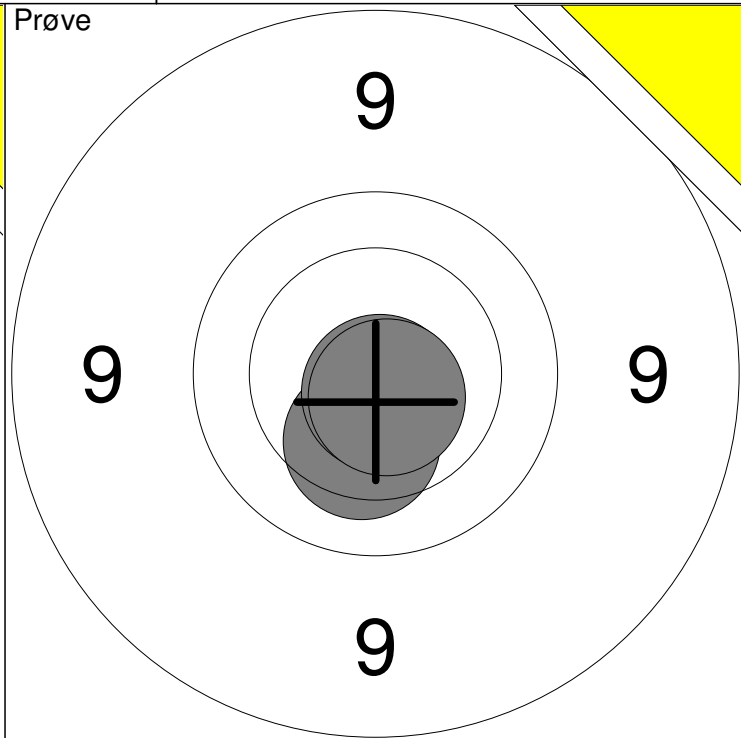

1: 10.0 ↘
2: 9.9 ↘
3: 10.4 →
4: *10.7 ↘
5: *10.5 →

6: 9.7 ↘
7: *10.7 ↗
8: 10.2 ↘
9: 9.9 ↘
10: 10.2 ↘

Serie 97.0
Total 0.0

11: 10.3 ↘
12: *10.8 ↘
13: *10.7 ↘

Serie 30.0
Total 0.0

20 Skud

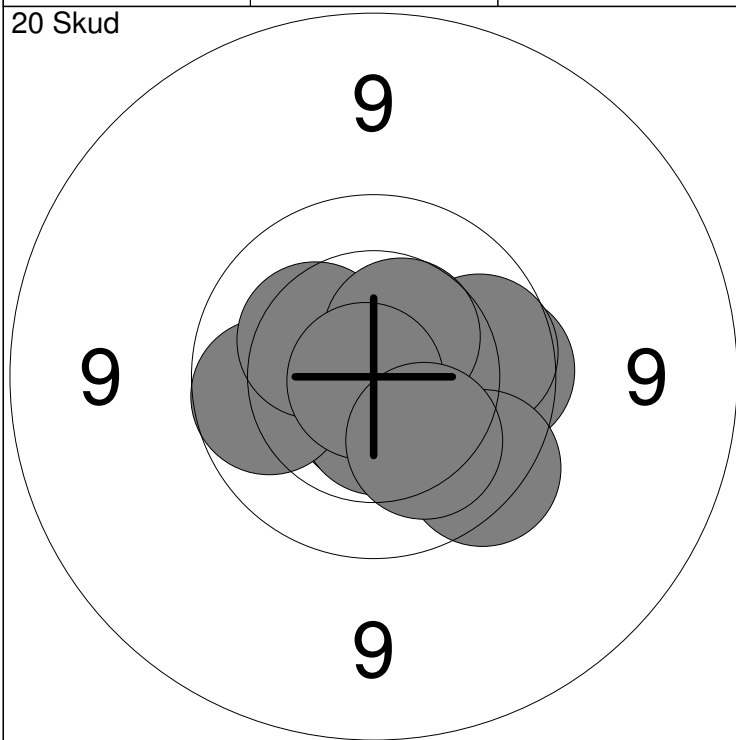

20 Skud

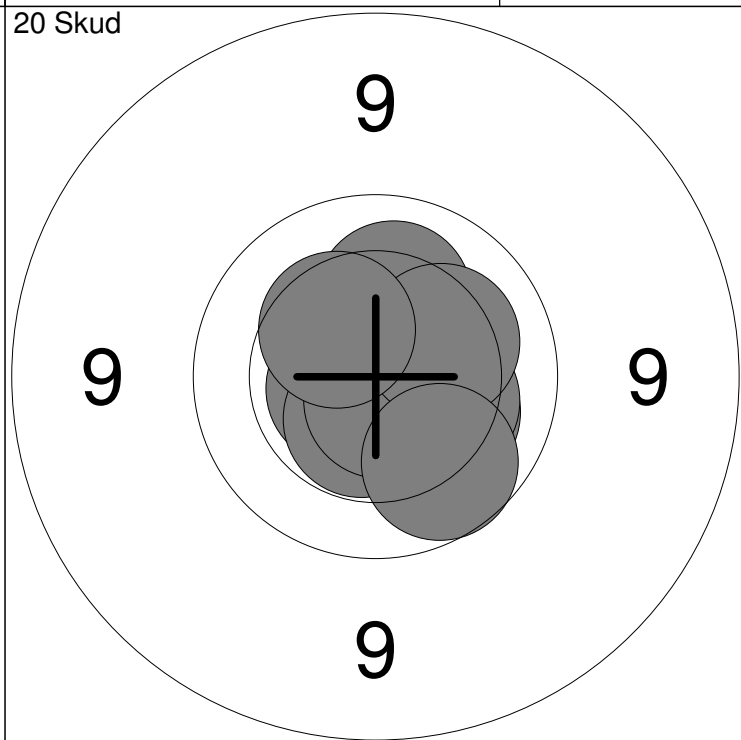

1: 9.8 →
2: 9.9 →
3: *10.6 ↘
4: *10.6 ↘
5: 9.9 ←

6: 10.3 ↗
7: 10.5 ↗
8: 9.7 ↘
9: *10.9 ←
10: 10.2 ↘

Serie 96.0
Total 96.0

11: 10.2 ↘
12: 10.2 ↑
13: 10.3 →
14: *10.6 ←
15: 10.4 ↘

16: *10.5 ↘
17: *10.7 ↘
18: 10.2 ↗
19: 10.4 ↗
20: 9.9 ↘

Serie 99.0
Total 195.0

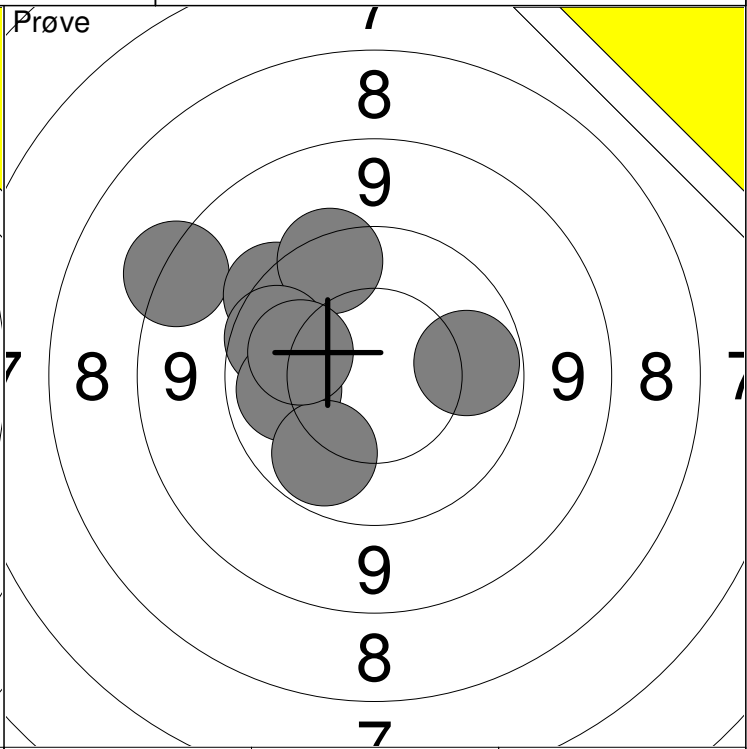
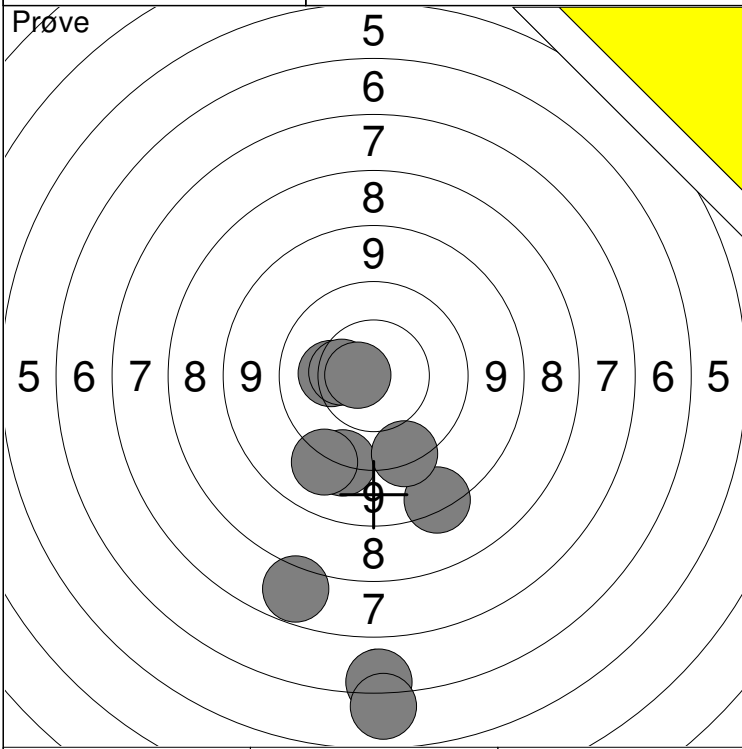

| | | | | | | | |
|----------|-------------|-----------|------------|------------|------------|-------|------------|
| 1: 7.0 ↓ | 6: 9.5 ↓ | Serie | 82.0 | 11: 8.5 ↗ | 16: 10.1 ← | Serie | 75.0 |
| 2: 5.6 ↓ | 7: 10.3 ← | | Total | 0.0 | 12: 9.6 ↗ | | 17: 10.0 ↓ |
| 3: 5.1 ↓ | 8: 10.4 ← | 13: 9.6 ↗ | | 18: 10.1 ← | | | |
| 4: 9.4 ↓ | 9: 9.3 ↓ | 14: 9.9 ↗ | 15: 10.0 → | | | | |
| 5: 8.5 ↓ | 10: *10.7 ← | | | | | | |

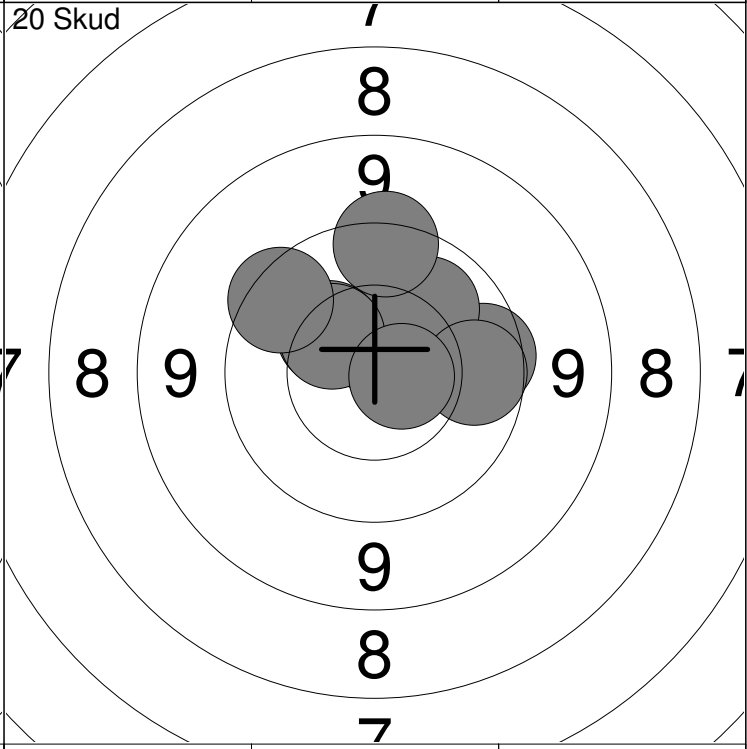
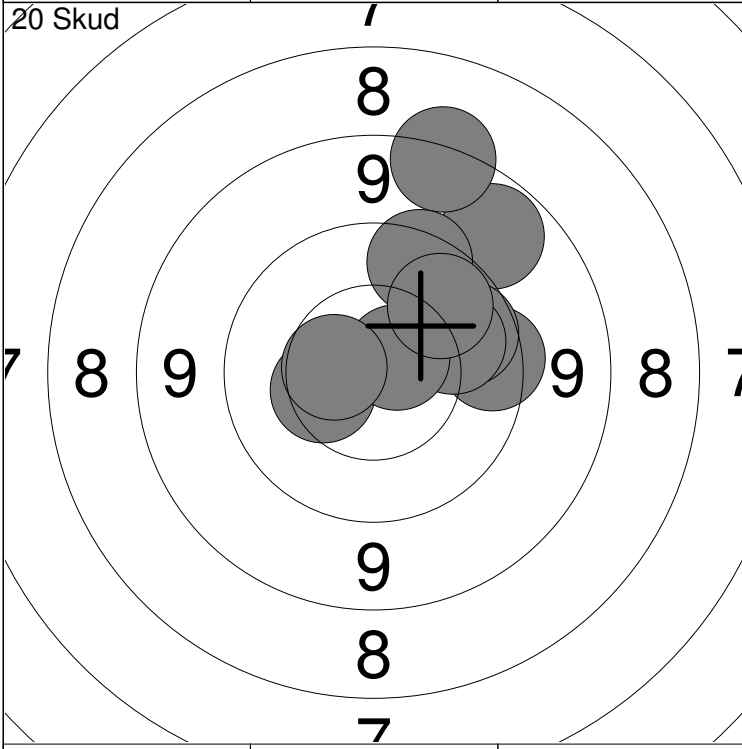

| | | | | | | | |
|-----------|------------|------------|-------------|------------|-------------|-------|------------|
| 1: 9.0 ↗ | 6: 9.7 ↗ | Serie | 94.0 | 11: 9.8 → | 16: 9.6 ↑ | Serie | 96.0 |
| 2: 9.7 → | 7: 10.1 → | | Total | 94.0 | 12: *10.6 ↑ | | 17: 10.3 ↗ |
| 3: 8.5 ↑ | 8: *10.7 → | 13: 10.2 → | | 18: 10.4 ↗ | | | |
| 4: 10.4 ← | 9: 10.5 ← | 14: 10.1 ↗ | 19: 9.7 ↗ | | | | |
| 5: 9.9 → | 10: 10.0 ↗ | 15: 9.9 → | 20: *10.7 → | | | | |

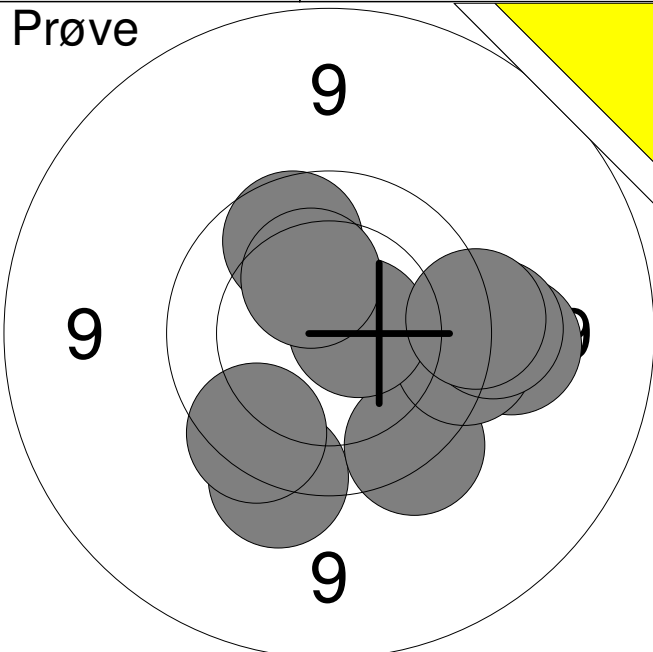
| | | | | | | | | | | | | | | | | | | | | | | | | | | | | | | | | | | | | | |
|--|---|------|-----|---|----|-----|---|----|-----|---|----|-----|---|----|-----|---|----|-----|---|----|-------|---|----|-----|---|----|------|---|-----|-----|---|-------|--|------|-------|--|-----|
| <p>Prøve</p>  | <table style="width:100%; border-collapse: collapse;"> <tr><td style="text-align: right;">1:</td><td style="text-align: center;">9.4</td><td style="text-align: right;">→</td></tr> <tr><td style="text-align: right;">2:</td><td style="text-align: center;">9.6</td><td style="text-align: right;">↙</td></tr> <tr><td style="text-align: right;">3:</td><td style="text-align: center;">9.7</td><td style="text-align: right;">↙</td></tr> <tr><td style="text-align: right;">4:</td><td style="text-align: center;">9.7</td><td style="text-align: right;">→</td></tr> <tr><td style="text-align: right;">5:</td><td style="text-align: center;">9.5</td><td style="text-align: right;">→</td></tr> <tr><td style="text-align: right;">6:</td><td style="text-align: center;">9.8</td><td style="text-align: right;">↙</td></tr> <tr><td style="text-align: right;">7:</td><td style="text-align: center;">*10.6</td><td style="text-align: right;">→</td></tr> <tr><td style="text-align: right;">8:</td><td style="text-align: center;">9.9</td><td style="text-align: right;">↗</td></tr> <tr><td style="text-align: right;">9:</td><td style="text-align: center;">10.3</td><td style="text-align: right;">↗</td></tr> <tr><td style="text-align: right;">10:</td><td style="text-align: center;">9.6</td><td style="text-align: right;">→</td></tr> <tr style="border-top: 1px solid black;"><td colspan="2">Serie</td><td style="text-align: right;">92.0</td></tr> <tr><td colspan="2">Total</td><td style="text-align: right;">0.0</td></tr> </table> | 1: | 9.4 | → | 2: | 9.6 | ↙ | 3: | 9.7 | ↙ | 4: | 9.7 | → | 5: | 9.5 | → | 6: | 9.8 | ↙ | 7: | *10.6 | → | 8: | 9.9 | ↗ | 9: | 10.3 | ↗ | 10: | 9.6 | → | Serie | | 92.0 | Total | | 0.0 |
| 1: | 9.4 | → | | | | | | | | | | | | | | | | | | | | | | | | | | | | | | | | | | | |
| 2: | 9.6 | ↙ | | | | | | | | | | | | | | | | | | | | | | | | | | | | | | | | | | | |
| 3: | 9.7 | ↙ | | | | | | | | | | | | | | | | | | | | | | | | | | | | | | | | | | | |
| 4: | 9.7 | → | | | | | | | | | | | | | | | | | | | | | | | | | | | | | | | | | | | |
| 5: | 9.5 | → | | | | | | | | | | | | | | | | | | | | | | | | | | | | | | | | | | | |
| 6: | 9.8 | ↙ | | | | | | | | | | | | | | | | | | | | | | | | | | | | | | | | | | | |
| 7: | *10.6 | → | | | | | | | | | | | | | | | | | | | | | | | | | | | | | | | | | | | |
| 8: | 9.9 | ↗ | | | | | | | | | | | | | | | | | | | | | | | | | | | | | | | | | | | |
| 9: | 10.3 | ↗ | | | | | | | | | | | | | | | | | | | | | | | | | | | | | | | | | | | |
| 10: | 9.6 | → | | | | | | | | | | | | | | | | | | | | | | | | | | | | | | | | | | | |
| Serie | | 92.0 | | | | | | | | | | | | | | | | | | | | | | | | | | | | | | | | | | | |
| Total | | 0.0 | | | | | | | | | | | | | | | | | | | | | | | | | | | | | | | | | | | |

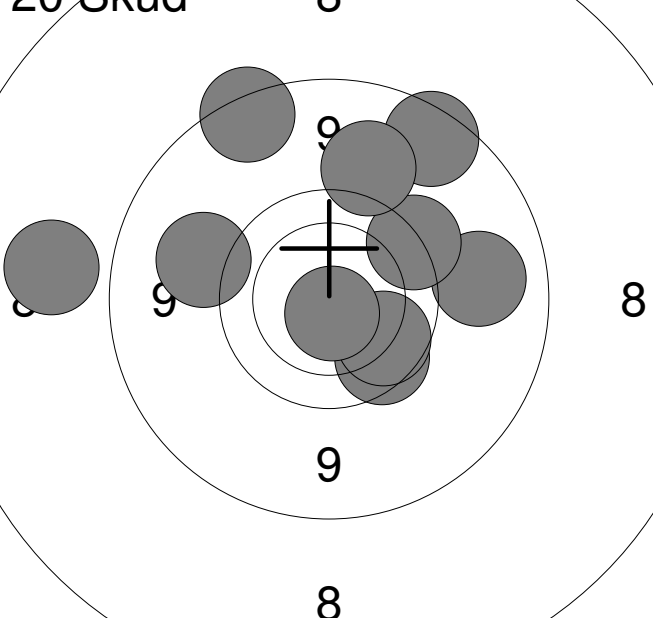
| | | | | | | | | | | | | | | | | | | | | | | | | | | | | | | | | | | | | | |
|---|---|------|-----|---|----|-----|---|----|-----|---|----|-----|---|----|-----|---|----|-----|---|----|-----|---|----|-----|---|----|-----|---|-----|-------|---|-------|--|------|-------|--|------|
| <p>20 Skud</p>  | <table style="width:100%; border-collapse: collapse;"> <tr><td style="text-align: right;">1:</td><td style="text-align: center;">9.1</td><td style="text-align: right;">→</td></tr> <tr><td style="text-align: right;">2:</td><td style="text-align: center;">9.8</td><td style="text-align: right;">↙</td></tr> <tr><td style="text-align: right;">3:</td><td style="text-align: center;">9.6</td><td style="text-align: right;">↗</td></tr> <tr><td style="text-align: right;">4:</td><td style="text-align: center;">8.8</td><td style="text-align: right;">↗</td></tr> <tr><td style="text-align: right;">5:</td><td style="text-align: center;">9.3</td><td style="text-align: right;">↗</td></tr> <tr><td style="text-align: right;">6:</td><td style="text-align: center;">8.8</td><td style="text-align: right;">↗</td></tr> <tr><td style="text-align: right;">7:</td><td style="text-align: center;">9.3</td><td style="text-align: right;">↗</td></tr> <tr><td style="text-align: right;">8:</td><td style="text-align: center;">9.9</td><td style="text-align: right;">↙</td></tr> <tr><td style="text-align: right;">9:</td><td style="text-align: center;">8.3</td><td style="text-align: right;">←</td></tr> <tr><td style="text-align: right;">10:</td><td style="text-align: center;">*10.7</td><td style="text-align: right;">↙</td></tr> <tr style="border-top: 1px solid black;"><td colspan="2">Serie</td><td style="text-align: right;">88.0</td></tr> <tr><td colspan="2">Total</td><td style="text-align: right;">88.0</td></tr> </table> | 1: | 9.1 | → | 2: | 9.8 | ↙ | 3: | 9.6 | ↗ | 4: | 8.8 | ↗ | 5: | 9.3 | ↗ | 6: | 8.8 | ↗ | 7: | 9.3 | ↗ | 8: | 9.9 | ↙ | 9: | 8.3 | ← | 10: | *10.7 | ↙ | Serie | | 88.0 | Total | | 88.0 |
| 1: | 9.1 | → | | | | | | | | | | | | | | | | | | | | | | | | | | | | | | | | | | | |
| 2: | 9.8 | ↙ | | | | | | | | | | | | | | | | | | | | | | | | | | | | | | | | | | | |
| 3: | 9.6 | ↗ | | | | | | | | | | | | | | | | | | | | | | | | | | | | | | | | | | | |
| 4: | 8.8 | ↗ | | | | | | | | | | | | | | | | | | | | | | | | | | | | | | | | | | | |
| 5: | 9.3 | ↗ | | | | | | | | | | | | | | | | | | | | | | | | | | | | | | | | | | | |
| 6: | 8.8 | ↗ | | | | | | | | | | | | | | | | | | | | | | | | | | | | | | | | | | | |
| 7: | 9.3 | ↗ | | | | | | | | | | | | | | | | | | | | | | | | | | | | | | | | | | | |
| 8: | 9.9 | ↙ | | | | | | | | | | | | | | | | | | | | | | | | | | | | | | | | | | | |
| 9: | 8.3 | ← | | | | | | | | | | | | | | | | | | | | | | | | | | | | | | | | | | | |
| 10: | *10.7 | ↙ | | | | | | | | | | | | | | | | | | | | | | | | | | | | | | | | | | | |
| Serie | | 88.0 | | | | | | | | | | | | | | | | | | | | | | | | | | | | | | | | | | | |
| Total | | 88.0 | | | | | | | | | | | | | | | | | | | | | | | | | | | | | | | | | | | |

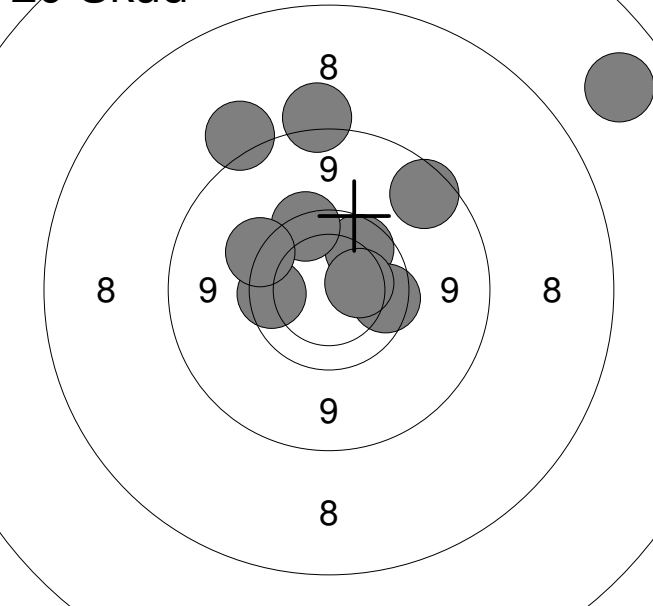
| | | | | | | | | | | | | | | | | | | | | | | | | | | | | | | | | | | | | | |
|--|--|-------|-----|---|-----|-----|---|-----|-----|---|-----|-----|---|-----|-----|---|-----|-----|---|-----|-----|---|-----|------|---|-----|-----|---|-----|-----|---|-------|--|------|-------|--|-------|
| <p>20 Skud</p>  | <table style="width:100%; border-collapse: collapse;"> <tr><td style="text-align: right;">11:</td><td style="text-align: center;">9.9</td><td style="text-align: right;">↗</td></tr> <tr><td style="text-align: right;">12:</td><td style="text-align: center;">8.5</td><td style="text-align: right;">↗</td></tr> <tr><td style="text-align: right;">13:</td><td style="text-align: center;">9.7</td><td style="text-align: right;">↗</td></tr> <tr><td style="text-align: right;">14:</td><td style="text-align: center;">8.6</td><td style="text-align: right;">↗</td></tr> <tr><td style="text-align: right;">15:</td><td style="text-align: center;">7.1</td><td style="text-align: right;">↗</td></tr> <tr><td style="text-align: right;">16:</td><td style="text-align: center;">9.8</td><td style="text-align: right;">←</td></tr> <tr><td style="text-align: right;">17:</td><td style="text-align: center;">9.8</td><td style="text-align: right;">→</td></tr> <tr><td style="text-align: right;">18:</td><td style="text-align: center;">10.3</td><td style="text-align: right;">→</td></tr> <tr><td style="text-align: right;">19:</td><td style="text-align: center;">9.5</td><td style="text-align: right;">↗</td></tr> <tr><td style="text-align: right;">20:</td><td style="text-align: center;">8.9</td><td style="text-align: right;">↗</td></tr> <tr style="border-top: 1px solid black;"><td colspan="2">Serie</td><td style="text-align: right;">86.0</td></tr> <tr><td colspan="2">Total</td><td style="text-align: right;">174.0</td></tr> </table> | 11: | 9.9 | ↗ | 12: | 8.5 | ↗ | 13: | 9.7 | ↗ | 14: | 8.6 | ↗ | 15: | 7.1 | ↗ | 16: | 9.8 | ← | 17: | 9.8 | → | 18: | 10.3 | → | 19: | 9.5 | ↗ | 20: | 8.9 | ↗ | Serie | | 86.0 | Total | | 174.0 |
| 11: | 9.9 | ↗ | | | | | | | | | | | | | | | | | | | | | | | | | | | | | | | | | | | |
| 12: | 8.5 | ↗ | | | | | | | | | | | | | | | | | | | | | | | | | | | | | | | | | | | |
| 13: | 9.7 | ↗ | | | | | | | | | | | | | | | | | | | | | | | | | | | | | | | | | | | |
| 14: | 8.6 | ↗ | | | | | | | | | | | | | | | | | | | | | | | | | | | | | | | | | | | |
| 15: | 7.1 | ↗ | | | | | | | | | | | | | | | | | | | | | | | | | | | | | | | | | | | |
| 16: | 9.8 | ← | | | | | | | | | | | | | | | | | | | | | | | | | | | | | | | | | | | |
| 17: | 9.8 | → | | | | | | | | | | | | | | | | | | | | | | | | | | | | | | | | | | | |
| 18: | 10.3 | → | | | | | | | | | | | | | | | | | | | | | | | | | | | | | | | | | | | |
| 19: | 9.5 | ↗ | | | | | | | | | | | | | | | | | | | | | | | | | | | | | | | | | | | |
| 20: | 8.9 | ↗ | | | | | | | | | | | | | | | | | | | | | | | | | | | | | | | | | | | |
| Serie | | 86.0 | | | | | | | | | | | | | | | | | | | | | | | | | | | | | | | | | | | |
| Total | | 174.0 | | | | | | | | | | | | | | | | | | | | | | | | | | | | | | | | | | | |

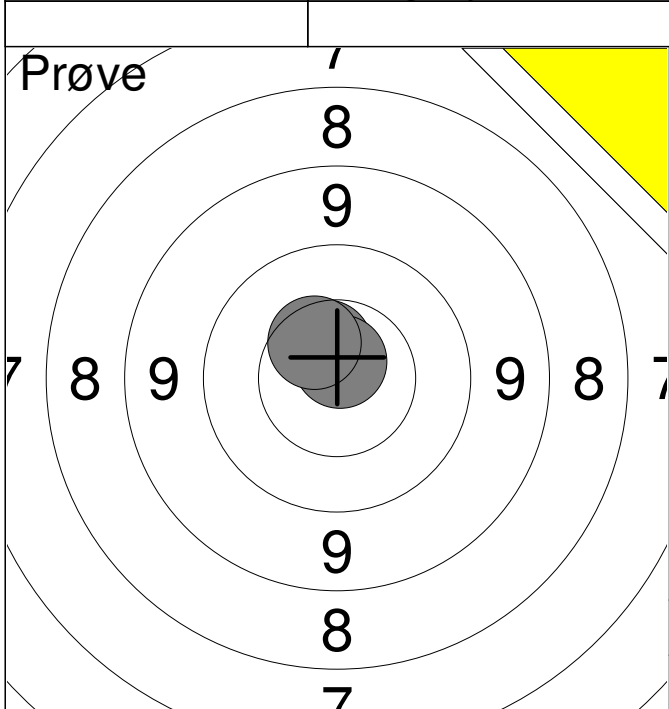

| | | | |
|--------------|----|-------|------|
| | 1: | 10.6 | ↑ |
| | 2: | *10.8 | ↑ |
| | 3: | 10.5 | ↑ |
| Serie | | | 30.0 |
| Total | | | 0.0 |

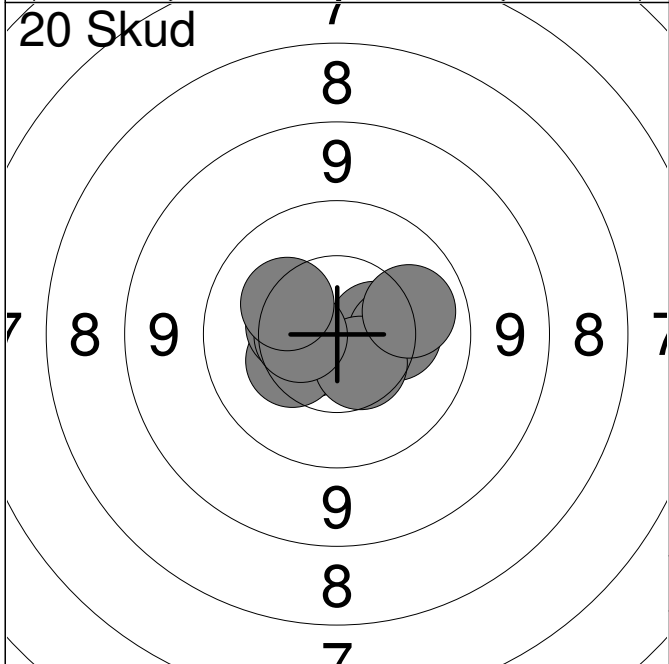

| | | | |
|--------------|-----|-------|-------|
| | 1: | 10.6 | → |
| | 2: | *10.6 | ↙ |
| | 3: | 10.4 | ↙ |
| | 4: | 10.5 | → |
| | 5: | 10.3 | → |
| | 6: | 10.5 | ↙ |
| | 7: | 10.4 | ← |
| | 8: | 10.5 | ← |
| | 9: | 10.1 | → |
| | 10: | 10.3 | ↗ |
| Serie | | | 100.0 |
| Total | | | 100.0 |

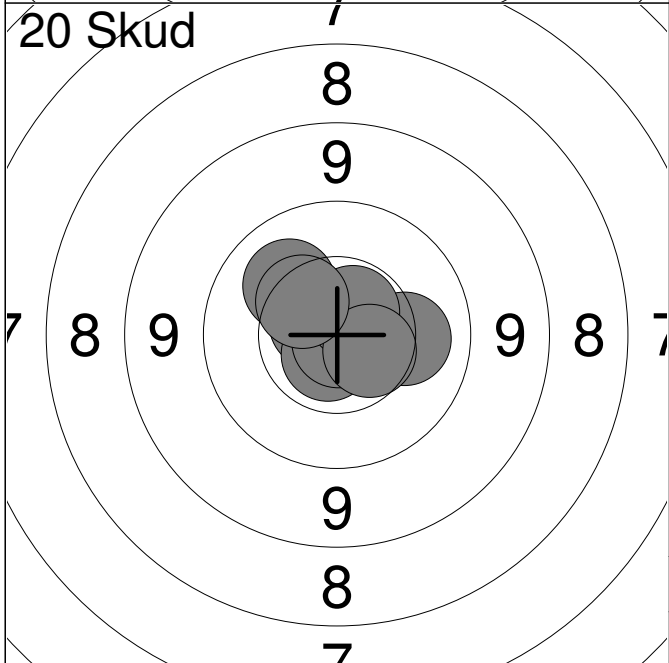

| | | | |
|--------------|-----|-------|-------|
| | 11: | 10.2 | → |
| | 12: | *10.7 | ↗ |
| | 13: | 10.2 | ↗ |
| | 14: | *10.9 | → |
| | 15: | *10.8 | ↙ |
| | 16: | *10.7 | ↙ |
| | 17: | *10.9 | ↙ |
| | 18: | *10.6 | ↗ |
| | 19: | 10.5 | ↙ |
| | 20: | 10.4 | ↗ |
| Serie | | | 100.0 |
| Total | | | 200.0 |

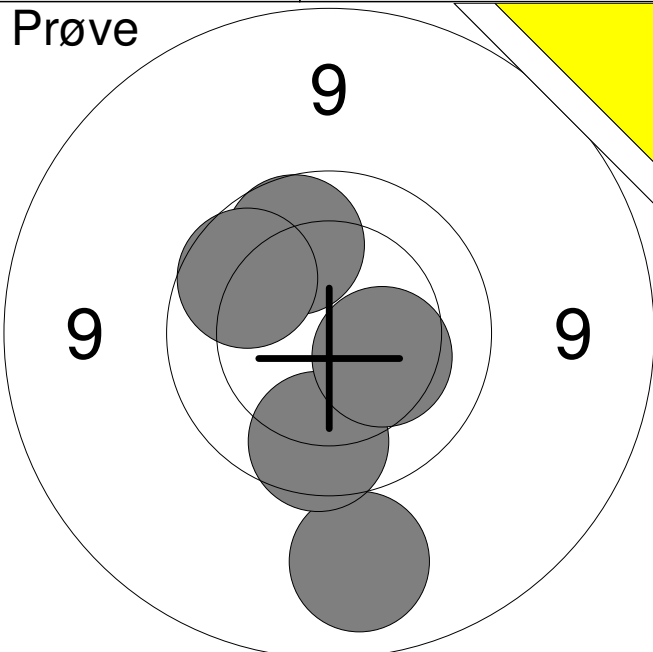
| | | | | | | | | | | | | | | | | | | | | |
|--|---|----|-----|---|----|-----|---|----|-----|---|----|-----|---|----|------|---|-------|------|-------|-----|
| <p>Prøve</p>  | <table style="width:100%; border-collapse: collapse;"> <tr><td style="text-align: right;">1:</td><td style="text-align: right;">9.1</td><td style="text-align: right;">↓</td></tr> <tr><td style="text-align: right;">2:</td><td style="text-align: right;">9.9</td><td style="text-align: right;">↓</td></tr> <tr><td style="text-align: right;">3:</td><td style="text-align: right;">9.9</td><td style="text-align: right;">↑</td></tr> <tr><td style="text-align: right;">4:</td><td style="text-align: right;">9.9</td><td style="text-align: right;">↑</td></tr> <tr><td style="text-align: right;">5:</td><td style="text-align: right;">10.3</td><td style="text-align: right;">↓</td></tr> </table> <table border="1" style="width:100%; border-collapse: collapse; margin-top: 10px;"> <tr> <td style="width:80%;">Serie</td> <td style="text-align: right;">46.0</td> </tr> <tr> <td>Total</td> <td style="text-align: right;">0.0</td> </tr> </table> | 1: | 9.1 | ↓ | 2: | 9.9 | ↓ | 3: | 9.9 | ↑ | 4: | 9.9 | ↑ | 5: | 10.3 | ↓ | Serie | 46.0 | Total | 0.0 |
| 1: | 9.1 | ↓ | | | | | | | | | | | | | | | | | | |
| 2: | 9.9 | ↓ | | | | | | | | | | | | | | | | | | |
| 3: | 9.9 | ↑ | | | | | | | | | | | | | | | | | | |
| 4: | 9.9 | ↑ | | | | | | | | | | | | | | | | | | |
| 5: | 10.3 | ↓ | | | | | | | | | | | | | | | | | | |
| Serie | 46.0 | | | | | | | | | | | | | | | | | | | |
| Total | 0.0 | | | | | | | | | | | | | | | | | | | |

| | | | | | | | | | | | | | | | | | | | | | | | | | | | | | | | | | | | |
|---|--|----|-----|---|----|-------|---|----|-------|---|----|-------|---|----|------|---|----|------|---|----|-------|---|----|-------|---|----|-----|---|-----|-------|---|-------|------|-------|------|
| <p>20 Skud</p>  | <table style="width:100%; border-collapse: collapse;"> <tr><td style="text-align: right;">1:</td><td style="text-align: right;">9.9</td><td style="text-align: right;">↑</td></tr> <tr><td style="text-align: right;">2:</td><td style="text-align: right;">*10.5</td><td style="text-align: right;">↑</td></tr> <tr><td style="text-align: right;">3:</td><td style="text-align: right;">*10.9</td><td style="text-align: right;">↓</td></tr> <tr><td style="text-align: right;">4:</td><td style="text-align: right;">*10.6</td><td style="text-align: right;">↓</td></tr> <tr><td style="text-align: right;">5:</td><td style="text-align: right;">10.0</td><td style="text-align: right;">↑</td></tr> <tr><td style="text-align: right;">6:</td><td style="text-align: right;">10.0</td><td style="text-align: right;">↓</td></tr> <tr><td style="text-align: right;">7:</td><td style="text-align: right;">*10.6</td><td style="text-align: right;">↑</td></tr> <tr><td style="text-align: right;">8:</td><td style="text-align: right;">*10.6</td><td style="text-align: right;">↑</td></tr> <tr><td style="text-align: right;">9:</td><td style="text-align: right;">9.5</td><td style="text-align: right;">←</td></tr> <tr><td style="text-align: right;">10:</td><td style="text-align: right;">*10.8</td><td style="text-align: right;">←</td></tr> </table> <table border="1" style="width:100%; border-collapse: collapse; margin-top: 10px;"> <tr> <td style="width:80%;">Serie</td> <td style="text-align: right;">98.0</td> </tr> <tr> <td>Total</td> <td style="text-align: right;">98.0</td> </tr> </table> | 1: | 9.9 | ↑ | 2: | *10.5 | ↑ | 3: | *10.9 | ↓ | 4: | *10.6 | ↓ | 5: | 10.0 | ↑ | 6: | 10.0 | ↓ | 7: | *10.6 | ↑ | 8: | *10.6 | ↑ | 9: | 9.5 | ← | 10: | *10.8 | ← | Serie | 98.0 | Total | 98.0 |
| 1: | 9.9 | ↑ | | | | | | | | | | | | | | | | | | | | | | | | | | | | | | | | | |
| 2: | *10.5 | ↑ | | | | | | | | | | | | | | | | | | | | | | | | | | | | | | | | | |
| 3: | *10.9 | ↓ | | | | | | | | | | | | | | | | | | | | | | | | | | | | | | | | | |
| 4: | *10.6 | ↓ | | | | | | | | | | | | | | | | | | | | | | | | | | | | | | | | | |
| 5: | 10.0 | ↑ | | | | | | | | | | | | | | | | | | | | | | | | | | | | | | | | | |
| 6: | 10.0 | ↓ | | | | | | | | | | | | | | | | | | | | | | | | | | | | | | | | | |
| 7: | *10.6 | ↑ | | | | | | | | | | | | | | | | | | | | | | | | | | | | | | | | | |
| 8: | *10.6 | ↑ | | | | | | | | | | | | | | | | | | | | | | | | | | | | | | | | | |
| 9: | 9.5 | ← | | | | | | | | | | | | | | | | | | | | | | | | | | | | | | | | | |
| 10: | *10.8 | ← | | | | | | | | | | | | | | | | | | | | | | | | | | | | | | | | | |
| Serie | 98.0 | | | | | | | | | | | | | | | | | | | | | | | | | | | | | | | | | | |
| Total | 98.0 | | | | | | | | | | | | | | | | | | | | | | | | | | | | | | | | | | |

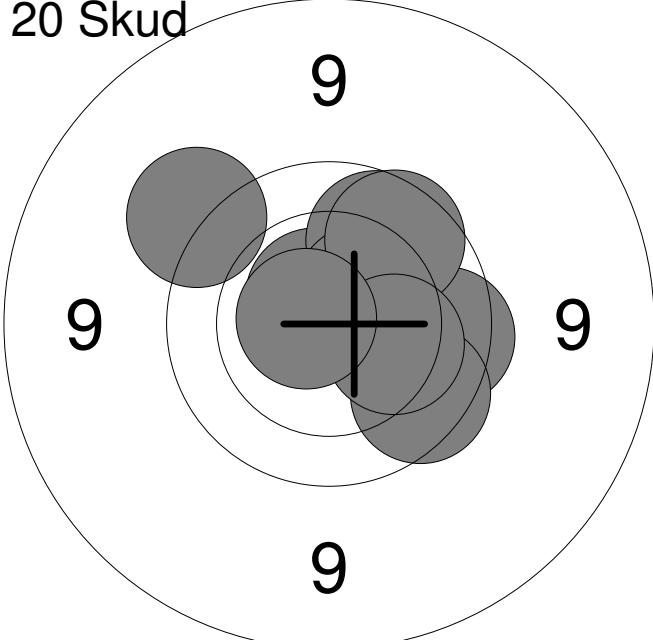
| | | | | | | | | | | | | | | | | | | | | | | | | | | | | | | | | | | | |
|--|---|-----|-------|---|-----|-----|---|-----|------|---|-----|-----|---|-----|------|---|-----|-----|---|-----|-----|---|-----|-----|---|-----|------|---|-----|-------|---|-------|------|-------|-------|
| <p>20 Skud</p>  | <table style="width:100%; border-collapse: collapse;"> <tr><td style="text-align: right;">11:</td><td style="text-align: right;">*10.6</td><td style="text-align: right;">↑</td></tr> <tr><td style="text-align: right;">12:</td><td style="text-align: right;">9.5</td><td style="text-align: right;">↑</td></tr> <tr><td style="text-align: right;">13:</td><td style="text-align: right;">10.1</td><td style="text-align: right;">→</td></tr> <tr><td style="text-align: right;">14:</td><td style="text-align: right;">9.9</td><td style="text-align: right;">↑</td></tr> <tr><td style="text-align: right;">15:</td><td style="text-align: right;">10.4</td><td style="text-align: right;">↑</td></tr> <tr><td style="text-align: right;">16:</td><td style="text-align: right;">9.8</td><td style="text-align: right;">→</td></tr> <tr><td style="text-align: right;">17:</td><td style="text-align: right;">9.9</td><td style="text-align: right;">↑</td></tr> <tr><td style="text-align: right;">18:</td><td style="text-align: right;">9.8</td><td style="text-align: right;">↓</td></tr> <tr><td style="text-align: right;">19:</td><td style="text-align: right;">10.2</td><td style="text-align: right;">↓</td></tr> <tr><td style="text-align: right;">20:</td><td style="text-align: right;">*10.7</td><td style="text-align: right;">←</td></tr> </table> <table border="1" style="width:100%; border-collapse: collapse; margin-top: 10px;"> <tr> <td style="width:80%;">Serie</td> <td style="text-align: right;">95.0</td> </tr> <tr> <td>Total</td> <td style="text-align: right;">193.0</td> </tr> </table> | 11: | *10.6 | ↑ | 12: | 9.5 | ↑ | 13: | 10.1 | → | 14: | 9.9 | ↑ | 15: | 10.4 | ↑ | 16: | 9.8 | → | 17: | 9.9 | ↑ | 18: | 9.8 | ↓ | 19: | 10.2 | ↓ | 20: | *10.7 | ← | Serie | 95.0 | Total | 193.0 |
| 11: | *10.6 | ↑ | | | | | | | | | | | | | | | | | | | | | | | | | | | | | | | | | |
| 12: | 9.5 | ↑ | | | | | | | | | | | | | | | | | | | | | | | | | | | | | | | | | |
| 13: | 10.1 | → | | | | | | | | | | | | | | | | | | | | | | | | | | | | | | | | | |
| 14: | 9.9 | ↑ | | | | | | | | | | | | | | | | | | | | | | | | | | | | | | | | | |
| 15: | 10.4 | ↑ | | | | | | | | | | | | | | | | | | | | | | | | | | | | | | | | | |
| 16: | 9.8 | → | | | | | | | | | | | | | | | | | | | | | | | | | | | | | | | | | |
| 17: | 9.9 | ↑ | | | | | | | | | | | | | | | | | | | | | | | | | | | | | | | | | |
| 18: | 9.8 | ↓ | | | | | | | | | | | | | | | | | | | | | | | | | | | | | | | | | |
| 19: | 10.2 | ↓ | | | | | | | | | | | | | | | | | | | | | | | | | | | | | | | | | |
| 20: | *10.7 | ← | | | | | | | | | | | | | | | | | | | | | | | | | | | | | | | | | |
| Serie | 95.0 | | | | | | | | | | | | | | | | | | | | | | | | | | | | | | | | | | |
| Total | 193.0 | | | | | | | | | | | | | | | | | | | | | | | | | | | | | | | | | | |

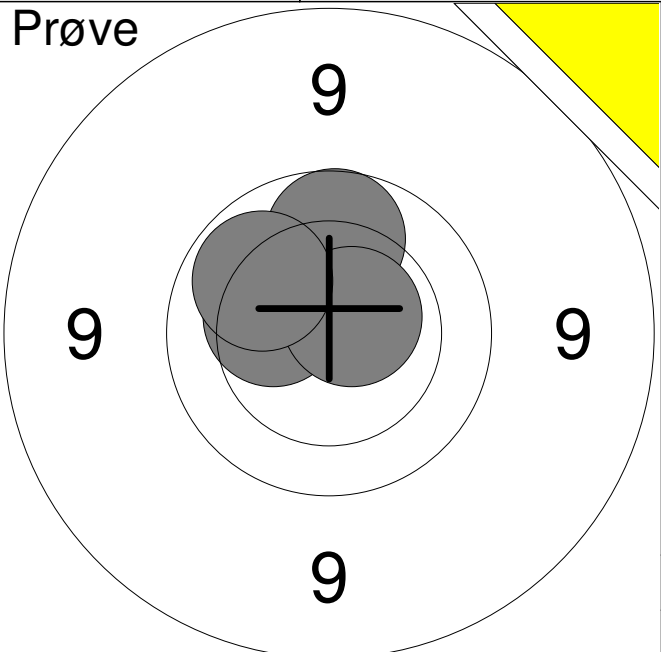
| | | | | | | | | | | | | | | | | | | | | | | |
|--|---|------|-----|---|----|------|---|----|-------|---|----|------|---|-------|--|--|-------|--|------|-------|--|-----|
| <p>Prøve</p>  | <table style="width:100%; border-collapse: collapse;"> <tr><td style="width:10%;">1:</td><td style="width:15%;">9.9</td><td style="width:10%; text-align: right;">↑</td></tr> <tr><td>2:</td><td>10.3</td><td style="text-align: right;">←</td></tr> <tr><td>3:</td><td>*10.6</td><td style="text-align: right;">↗</td></tr> <tr><td>4:</td><td>10.0</td><td style="text-align: right;">↗</td></tr> <tr><td colspan="3"><hr/></td></tr> <tr><td>Serie</td><td></td><td style="text-align: right;">39.0</td></tr> <tr><td>Total</td><td></td><td style="text-align: right;">0.0</td></tr> </table> | 1: | 9.9 | ↑ | 2: | 10.3 | ← | 3: | *10.6 | ↗ | 4: | 10.0 | ↗ | <hr/> | | | Serie | | 39.0 | Total | | 0.0 |
| 1: | 9.9 | ↑ | | | | | | | | | | | | | | | | | | | | |
| 2: | 10.3 | ← | | | | | | | | | | | | | | | | | | | | |
| 3: | *10.6 | ↗ | | | | | | | | | | | | | | | | | | | | |
| 4: | 10.0 | ↗ | | | | | | | | | | | | | | | | | | | | |
| <hr/> | | | | | | | | | | | | | | | | | | | | | | |
| Serie | | 39.0 | | | | | | | | | | | | | | | | | | | | |
| Total | | 0.0 | | | | | | | | | | | | | | | | | | | | |

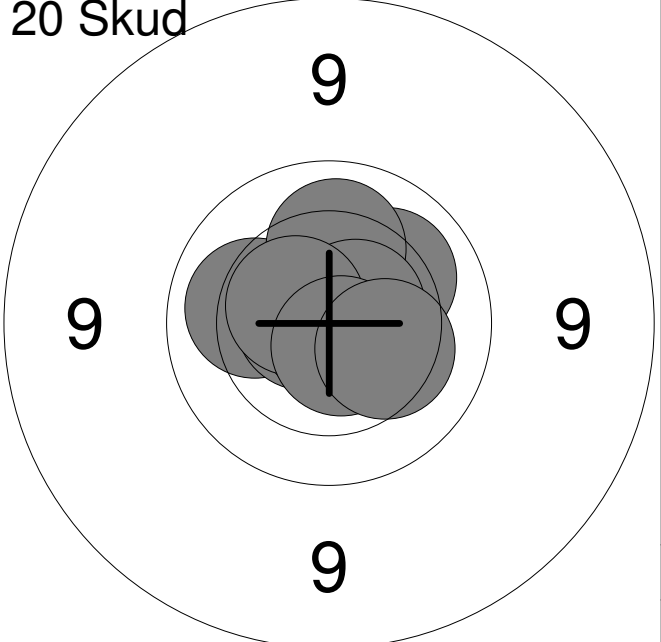
| | | | | | | | | | | | | | | | | | | | | | | | | | | | | | | | | | | | | | | | | |
|---|--|-------|------|---|----|------|---|----|-------|---|----|------|---|----|------|---|----|-------|---|----|-------|---|----|-------|---|----|-------|---|-----|------|---|-------|--|--|-------|--|-------|-------|--|-------|
| <p>20 Skud</p>  | <table style="width:100%; border-collapse: collapse;"> <tr><td style="width:10%;">1:</td><td style="width:15%;">10.2</td><td style="width:10%; text-align: right;">↗</td></tr> <tr><td>2:</td><td>10.1</td><td style="text-align: right;">←</td></tr> <tr><td>3:</td><td>*10.7</td><td style="text-align: right;">←</td></tr> <tr><td>4:</td><td>10.2</td><td style="text-align: right;">↗</td></tr> <tr><td>5:</td><td>10.1</td><td style="text-align: right;">↑</td></tr> <tr><td>6:</td><td>*10.9</td><td style="text-align: right;">↓</td></tr> <tr><td>7:</td><td>*10.6</td><td style="text-align: right;">↗</td></tr> <tr><td>8:</td><td>*10.5</td><td style="text-align: right;">↗</td></tr> <tr><td>9:</td><td>*10.7</td><td style="text-align: right;">↓</td></tr> <tr><td>10:</td><td>10.3</td><td style="text-align: right;">↘</td></tr> <tr><td colspan="3"><hr/></td></tr> <tr><td>Serie</td><td></td><td style="text-align: right;">100.0</td></tr> <tr><td>Total</td><td></td><td style="text-align: right;">100.0</td></tr> </table> | 1: | 10.2 | ↗ | 2: | 10.1 | ← | 3: | *10.7 | ← | 4: | 10.2 | ↗ | 5: | 10.1 | ↑ | 6: | *10.9 | ↓ | 7: | *10.6 | ↗ | 8: | *10.5 | ↗ | 9: | *10.7 | ↓ | 10: | 10.3 | ↘ | <hr/> | | | Serie | | 100.0 | Total | | 100.0 |
| 1: | 10.2 | ↗ | | | | | | | | | | | | | | | | | | | | | | | | | | | | | | | | | | | | | | |
| 2: | 10.1 | ← | | | | | | | | | | | | | | | | | | | | | | | | | | | | | | | | | | | | | | |
| 3: | *10.7 | ← | | | | | | | | | | | | | | | | | | | | | | | | | | | | | | | | | | | | | | |
| 4: | 10.2 | ↗ | | | | | | | | | | | | | | | | | | | | | | | | | | | | | | | | | | | | | | |
| 5: | 10.1 | ↑ | | | | | | | | | | | | | | | | | | | | | | | | | | | | | | | | | | | | | | |
| 6: | *10.9 | ↓ | | | | | | | | | | | | | | | | | | | | | | | | | | | | | | | | | | | | | | |
| 7: | *10.6 | ↗ | | | | | | | | | | | | | | | | | | | | | | | | | | | | | | | | | | | | | | |
| 8: | *10.5 | ↗ | | | | | | | | | | | | | | | | | | | | | | | | | | | | | | | | | | | | | | |
| 9: | *10.7 | ↓ | | | | | | | | | | | | | | | | | | | | | | | | | | | | | | | | | | | | | | |
| 10: | 10.3 | ↘ | | | | | | | | | | | | | | | | | | | | | | | | | | | | | | | | | | | | | | |
| <hr/> | | | | | | | | | | | | | | | | | | | | | | | | | | | | | | | | | | | | | | | | |
| Serie | | 100.0 | | | | | | | | | | | | | | | | | | | | | | | | | | | | | | | | | | | | | | |
| Total | | 100.0 | | | | | | | | | | | | | | | | | | | | | | | | | | | | | | | | | | | | | | |

| | | | | | | | | | | | | | | | | | | | | | | | | | | | | | | | | | | | | | | | | |
|--|---|-------|-------|---|-----|------|---|-----|------|---|-----|------|---|-----|-------|---|-----|------|---|-----|------|---|-----|-----|---|-----|------|---|-----|-------|---|-------|--|--|-------|--|------|-------|--|-------|
| <p>20 Skud</p>  | <table style="width:100%; border-collapse: collapse;"> <tr><td style="width:10%;">11:</td><td style="width:15%;">*10.8</td><td style="width:10%; text-align: right;">↑</td></tr> <tr><td>12:</td><td>10.4</td><td style="text-align: right;">←</td></tr> <tr><td>13:</td><td>10.4</td><td style="text-align: right;">↘</td></tr> <tr><td>14:</td><td>10.1</td><td style="text-align: right;">←</td></tr> <tr><td>15:</td><td>*10.7</td><td style="text-align: right;">↓</td></tr> <tr><td>16:</td><td>10.0</td><td style="text-align: right;">↘</td></tr> <tr><td>17:</td><td>10.4</td><td style="text-align: right;">↗</td></tr> <tr><td>18:</td><td>9.9</td><td style="text-align: right;">↗</td></tr> <tr><td>19:</td><td>10.1</td><td style="text-align: right;">→</td></tr> <tr><td>20:</td><td>*10.8</td><td style="text-align: right;">↗</td></tr> <tr><td colspan="3"><hr/></td></tr> <tr><td>Serie</td><td></td><td style="text-align: right;">99.0</td></tr> <tr><td>Total</td><td></td><td style="text-align: right;">199.0</td></tr> </table> | 11: | *10.8 | ↑ | 12: | 10.4 | ← | 13: | 10.4 | ↘ | 14: | 10.1 | ← | 15: | *10.7 | ↓ | 16: | 10.0 | ↘ | 17: | 10.4 | ↗ | 18: | 9.9 | ↗ | 19: | 10.1 | → | 20: | *10.8 | ↗ | <hr/> | | | Serie | | 99.0 | Total | | 199.0 |
| 11: | *10.8 | ↑ | | | | | | | | | | | | | | | | | | | | | | | | | | | | | | | | | | | | | | |
| 12: | 10.4 | ← | | | | | | | | | | | | | | | | | | | | | | | | | | | | | | | | | | | | | | |
| 13: | 10.4 | ↘ | | | | | | | | | | | | | | | | | | | | | | | | | | | | | | | | | | | | | | |
| 14: | 10.1 | ← | | | | | | | | | | | | | | | | | | | | | | | | | | | | | | | | | | | | | | |
| 15: | *10.7 | ↓ | | | | | | | | | | | | | | | | | | | | | | | | | | | | | | | | | | | | | | |
| 16: | 10.0 | ↘ | | | | | | | | | | | | | | | | | | | | | | | | | | | | | | | | | | | | | | |
| 17: | 10.4 | ↗ | | | | | | | | | | | | | | | | | | | | | | | | | | | | | | | | | | | | | | |
| 18: | 9.9 | ↗ | | | | | | | | | | | | | | | | | | | | | | | | | | | | | | | | | | | | | | |
| 19: | 10.1 | → | | | | | | | | | | | | | | | | | | | | | | | | | | | | | | | | | | | | | | |
| 20: | *10.8 | ↗ | | | | | | | | | | | | | | | | | | | | | | | | | | | | | | | | | | | | | | |
| <hr/> | | | | | | | | | | | | | | | | | | | | | | | | | | | | | | | | | | | | | | | | |
| Serie | | 99.0 | | | | | | | | | | | | | | | | | | | | | | | | | | | | | | | | | | | | | | |
| Total | | 199.0 | | | | | | | | | | | | | | | | | | | | | | | | | | | | | | | | | | | | | | |

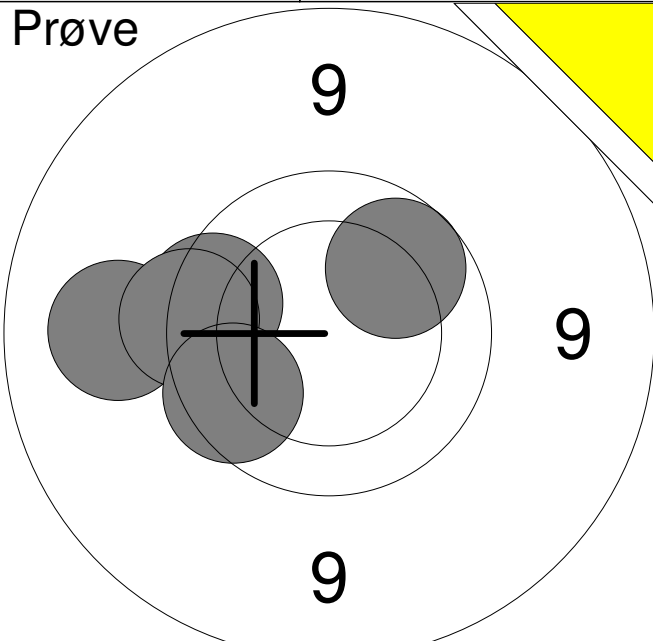
| | | | | | | | | | | | | | | | | | | | | |
|--|---|----|-----|---|----|-----|---|----|-----|---|----|-----|---|----|-----|---|-------|------|-------|-----|
| <p>Prøve</p>  | <table style="width:100%; border-collapse: collapse;"> <tr><td style="text-align: right;">1:</td><td style="text-align: right;">9.2</td><td style="text-align: right;">←</td></tr> <tr><td style="text-align: right;">2:</td><td style="text-align: right;">9.8</td><td style="text-align: right;">←</td></tr> <tr><td style="text-align: right;">3:</td><td style="text-align: right;">9.7</td><td style="text-align: right;">←</td></tr> <tr><td style="text-align: right;">4:</td><td style="text-align: right;">9.9</td><td style="text-align: right;">↗</td></tr> <tr><td style="text-align: right;">5:</td><td style="text-align: right;">9.8</td><td style="text-align: right;">←</td></tr> </table> <table border="1" style="width:100%; border-collapse: collapse; margin-top: 5px;"> <tr> <td style="width:80%;">Serie</td> <td style="text-align: right;">45.0</td> </tr> <tr> <td>Total</td> <td style="text-align: right;">0.0</td> </tr> </table> | 1: | 9.2 | ← | 2: | 9.8 | ← | 3: | 9.7 | ← | 4: | 9.9 | ↗ | 5: | 9.8 | ← | Serie | 45.0 | Total | 0.0 |
| 1: | 9.2 | ← | | | | | | | | | | | | | | | | | | |
| 2: | 9.8 | ← | | | | | | | | | | | | | | | | | | |
| 3: | 9.7 | ← | | | | | | | | | | | | | | | | | | |
| 4: | 9.9 | ↗ | | | | | | | | | | | | | | | | | | |
| 5: | 9.8 | ← | | | | | | | | | | | | | | | | | | |
| Serie | 45.0 | | | | | | | | | | | | | | | | | | | |
| Total | 0.0 | | | | | | | | | | | | | | | | | | | |

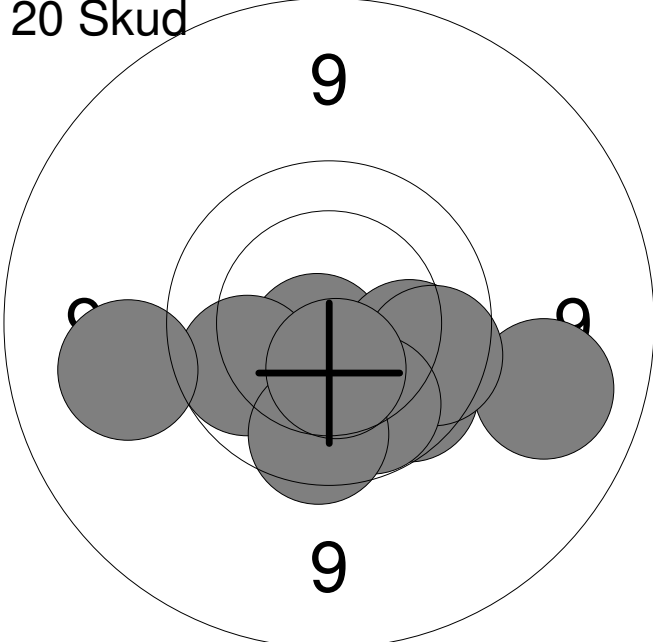
| | | | | | | | | | | | | | | | | | | | | | | | | | | | | | | | | | | | |
|---|---|----|-------|---|----|-----|---|----|-----|---|----|------|---|----|-----|---|----|------|---|----|------|---|----|-----|---|----|-----|---|-----|------|---|-------|------|-------|------|
| <p>20 Skud</p>  | <table style="width:100%; border-collapse: collapse;"> <tr><td style="text-align: right;">1:</td><td style="text-align: right;">*10.7</td><td style="text-align: right;">↙</td></tr> <tr><td style="text-align: right;">2:</td><td style="text-align: right;">9.9</td><td style="text-align: right;">↙</td></tr> <tr><td style="text-align: right;">3:</td><td style="text-align: right;">9.1</td><td style="text-align: right;">→</td></tr> <tr><td style="text-align: right;">4:</td><td style="text-align: right;">10.0</td><td style="text-align: right;">→</td></tr> <tr><td style="text-align: right;">5:</td><td style="text-align: right;">9.9</td><td style="text-align: right;">→</td></tr> <tr><td style="text-align: right;">6:</td><td style="text-align: right;">10.0</td><td style="text-align: right;">↙</td></tr> <tr><td style="text-align: right;">7:</td><td style="text-align: right;">10.0</td><td style="text-align: right;">←</td></tr> <tr><td style="text-align: right;">8:</td><td style="text-align: right;">9.2</td><td style="text-align: right;">←</td></tr> <tr><td style="text-align: right;">9:</td><td style="text-align: right;">9.8</td><td style="text-align: right;">↙</td></tr> <tr><td style="text-align: right;">10:</td><td style="text-align: right;">10.5</td><td style="text-align: right;">↙</td></tr> </table> <table border="1" style="width:100%; border-collapse: collapse; margin-top: 5px;"> <tr> <td style="width:80%;">Serie</td> <td style="text-align: right;">95.0</td> </tr> <tr> <td>Total</td> <td style="text-align: right;">95.0</td> </tr> </table> | 1: | *10.7 | ↙ | 2: | 9.9 | ↙ | 3: | 9.1 | → | 4: | 10.0 | → | 5: | 9.9 | → | 6: | 10.0 | ↙ | 7: | 10.0 | ← | 8: | 9.2 | ← | 9: | 9.8 | ↙ | 10: | 10.5 | ↙ | Serie | 95.0 | Total | 95.0 |
| 1: | *10.7 | ↙ | | | | | | | | | | | | | | | | | | | | | | | | | | | | | | | | | |
| 2: | 9.9 | ↙ | | | | | | | | | | | | | | | | | | | | | | | | | | | | | | | | | |
| 3: | 9.1 | → | | | | | | | | | | | | | | | | | | | | | | | | | | | | | | | | | |
| 4: | 10.0 | → | | | | | | | | | | | | | | | | | | | | | | | | | | | | | | | | | |
| 5: | 9.9 | → | | | | | | | | | | | | | | | | | | | | | | | | | | | | | | | | | |
| 6: | 10.0 | ↙ | | | | | | | | | | | | | | | | | | | | | | | | | | | | | | | | | |
| 7: | 10.0 | ← | | | | | | | | | | | | | | | | | | | | | | | | | | | | | | | | | |
| 8: | 9.2 | ← | | | | | | | | | | | | | | | | | | | | | | | | | | | | | | | | | |
| 9: | 9.8 | ↙ | | | | | | | | | | | | | | | | | | | | | | | | | | | | | | | | | |
| 10: | 10.5 | ↙ | | | | | | | | | | | | | | | | | | | | | | | | | | | | | | | | | |
| Serie | 95.0 | | | | | | | | | | | | | | | | | | | | | | | | | | | | | | | | | | |
| Total | 95.0 | | | | | | | | | | | | | | | | | | | | | | | | | | | | | | | | | | |

| | | | | | | | | | | | | | | | | | | | | | | | | | | | | | | | | | | | |
|--|--|-----|------|---|-----|------|---|-----|-----|---|-----|------|---|-----|------|---|-----|-----|---|-----|------|---|-----|-----|---|-----|------|---|-----|------|---|-------|------|-------|-------|
| <p>20 Skud</p>  | <table style="width:100%; border-collapse: collapse;"> <tr><td style="text-align: right;">11:</td><td style="text-align: right;">10.0</td><td style="text-align: right;">↗</td></tr> <tr><td style="text-align: right;">12:</td><td style="text-align: right;">10.1</td><td style="text-align: right;">↗</td></tr> <tr><td style="text-align: right;">13:</td><td style="text-align: right;">9.4</td><td style="text-align: right;">↗</td></tr> <tr><td style="text-align: right;">14:</td><td style="text-align: right;">10.1</td><td style="text-align: right;">↙</td></tr> <tr><td style="text-align: right;">15:</td><td style="text-align: right;">10.1</td><td style="text-align: right;">↗</td></tr> <tr><td style="text-align: right;">16:</td><td style="text-align: right;">9.7</td><td style="text-align: right;">↗</td></tr> <tr><td style="text-align: right;">17:</td><td style="text-align: right;">10.2</td><td style="text-align: right;">↙</td></tr> <tr><td style="text-align: right;">18:</td><td style="text-align: right;">9.2</td><td style="text-align: right;">↗</td></tr> <tr><td style="text-align: right;">19:</td><td style="text-align: right;">10.3</td><td style="text-align: right;">←</td></tr> <tr><td style="text-align: right;">20:</td><td style="text-align: right;">10.0</td><td style="text-align: right;">←</td></tr> </table> <table border="1" style="width:100%; border-collapse: collapse; margin-top: 5px;"> <tr> <td style="width:80%;">Serie</td> <td style="text-align: right;">97.0</td> </tr> <tr> <td>Total</td> <td style="text-align: right;">192.0</td> </tr> </table> | 11: | 10.0 | ↗ | 12: | 10.1 | ↗ | 13: | 9.4 | ↗ | 14: | 10.1 | ↙ | 15: | 10.1 | ↗ | 16: | 9.7 | ↗ | 17: | 10.2 | ↙ | 18: | 9.2 | ↗ | 19: | 10.3 | ← | 20: | 10.0 | ← | Serie | 97.0 | Total | 192.0 |
| 11: | 10.0 | ↗ | | | | | | | | | | | | | | | | | | | | | | | | | | | | | | | | | |
| 12: | 10.1 | ↗ | | | | | | | | | | | | | | | | | | | | | | | | | | | | | | | | | |
| 13: | 9.4 | ↗ | | | | | | | | | | | | | | | | | | | | | | | | | | | | | | | | | |
| 14: | 10.1 | ↙ | | | | | | | | | | | | | | | | | | | | | | | | | | | | | | | | | |
| 15: | 10.1 | ↗ | | | | | | | | | | | | | | | | | | | | | | | | | | | | | | | | | |
| 16: | 9.7 | ↗ | | | | | | | | | | | | | | | | | | | | | | | | | | | | | | | | | |
| 17: | 10.2 | ↙ | | | | | | | | | | | | | | | | | | | | | | | | | | | | | | | | | |
| 18: | 9.2 | ↗ | | | | | | | | | | | | | | | | | | | | | | | | | | | | | | | | | |
| 19: | 10.3 | ← | | | | | | | | | | | | | | | | | | | | | | | | | | | | | | | | | |
| 20: | 10.0 | ← | | | | | | | | | | | | | | | | | | | | | | | | | | | | | | | | | |
| Serie | 97.0 | | | | | | | | | | | | | | | | | | | | | | | | | | | | | | | | | | |
| Total | 192.0 | | | | | | | | | | | | | | | | | | | | | | | | | | | | | | | | | | |

Hold
6Skive
7**Birgitte Jørgensen**

Aalborg Skyttekreds

ÅK1

Prøve

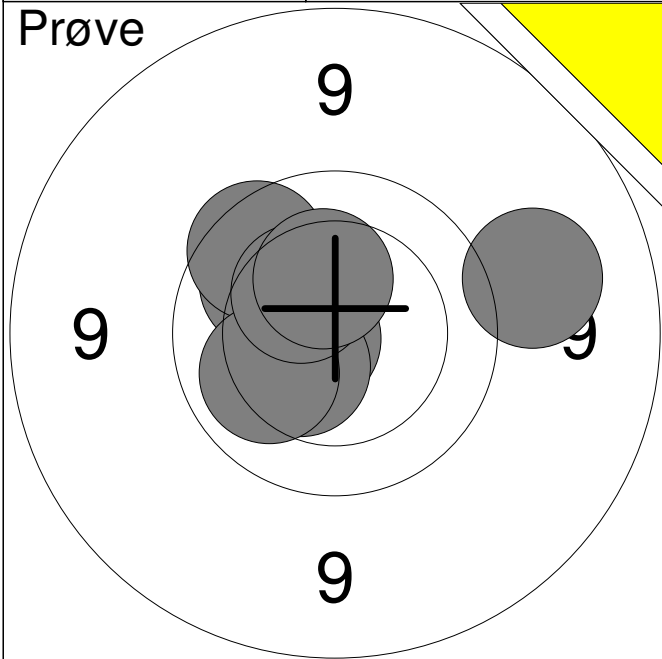

| | | |
|----|-------|---|
| 1: | 9.3 | → |
| 2: | 10.0 | ↗ |
| 3: | *10.7 | ← |
| 4: | 9.8 | ↗ |
| 5: | 10.4 | ↙ |
| 6: | 10.1 | ↙ |
| 7: | 10.4 | ↗ |
| 8: | 10.3 | ↑ |

Serie 78.0

Total 0.0

20 Skud

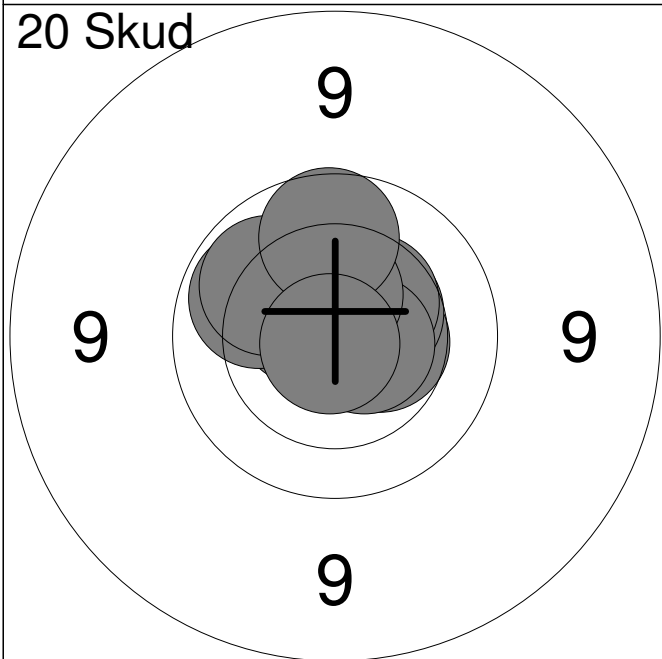

| | | |
|-----|-------|---|
| 1: | 10.5 | → |
| 2: | 10.5 | ↗ |
| 3: | *10.6 | ↗ |
| 4: | 10.4 | ↗ |
| 5: | *10.6 | → |
| 6: | *10.5 | ↑ |
| 7: | 10.0 | ↗ |
| 8: | 10.1 | ↗ |
| 9: | 9.9 | ↑ |
| 10: | *10.8 | ↙ |

Serie 99.0

Total 99.0

20 Skud

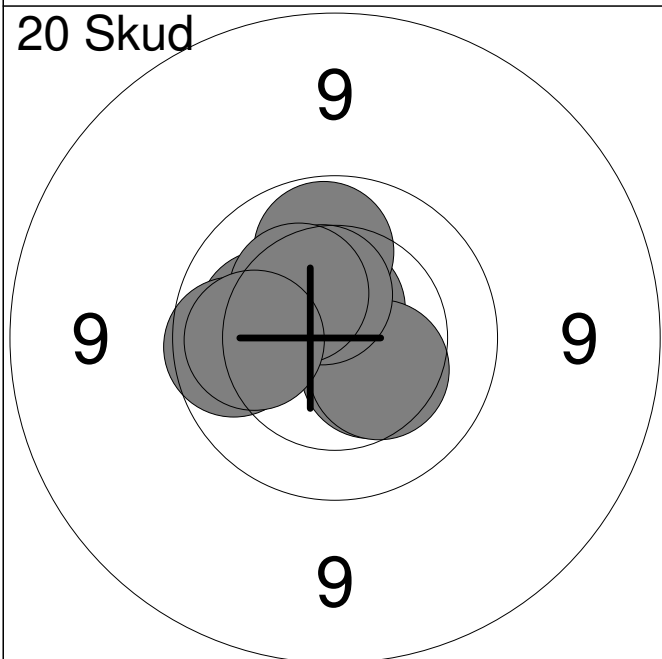

| | | |
|-----|-------|---|
| 11: | 10.4 | ↘ |
| 12: | 10.2 | ← |
| 13: | *10.6 | ↑ |
| 14: | *10.5 | ↗ |
| 15: | 10.4 | ↘ |
| 16: | 9.9 | ← |
| 17: | 10.0 | ↑ |
| 18: | 10.5 | ↗ |
| 19: | 10.3 | ↗ |
| 20: | 10.1 | ← |

Serie 99.0

Total 198.0

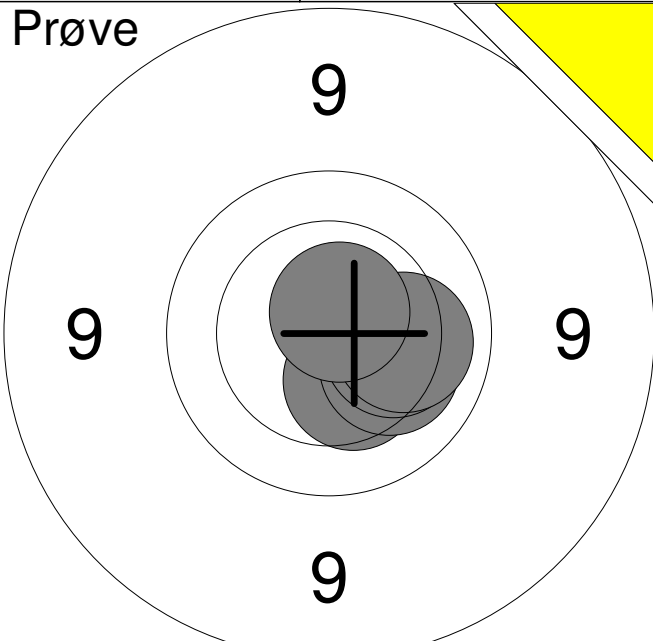
| | | | | | | | | | | | | | | | | | | | | |
|--|--|----|------|---|----|------|---|----|------|---|----|------|---|----|-------|---|-------|------|-------|-----|
| <p>Prøve</p>  | <table style="width:100%; border-collapse: collapse;"> <tr><td style="text-align: right;">1:</td><td style="text-align: right;">10.4</td><td style="text-align: right;">↘</td></tr> <tr><td style="text-align: right;">2:</td><td style="text-align: right;">10.2</td><td style="text-align: right;">↘</td></tr> <tr><td style="text-align: right;">3:</td><td style="text-align: right;">10.2</td><td style="text-align: right;">→</td></tr> <tr><td style="text-align: right;">4:</td><td style="text-align: right;">10.1</td><td style="text-align: right;">→</td></tr> <tr><td style="text-align: right;">5:</td><td style="text-align: right;">*10.7</td><td style="text-align: right;">↗</td></tr> </table> <table border="1" style="width:100%; border-collapse: collapse; margin-top: 10px;"> <tr> <td style="width:80%;">Serie</td> <td style="text-align: right;">50.0</td> </tr> <tr> <td>Total</td> <td style="text-align: right;">0.0</td> </tr> </table> | 1: | 10.4 | ↘ | 2: | 10.2 | ↘ | 3: | 10.2 | → | 4: | 10.1 | → | 5: | *10.7 | ↗ | Serie | 50.0 | Total | 0.0 |
| 1: | 10.4 | ↘ | | | | | | | | | | | | | | | | | | |
| 2: | 10.2 | ↘ | | | | | | | | | | | | | | | | | | |
| 3: | 10.2 | → | | | | | | | | | | | | | | | | | | |
| 4: | 10.1 | → | | | | | | | | | | | | | | | | | | |
| 5: | *10.7 | ↗ | | | | | | | | | | | | | | | | | | |
| Serie | 50.0 | | | | | | | | | | | | | | | | | | | |
| Total | 0.0 | | | | | | | | | | | | | | | | | | | |

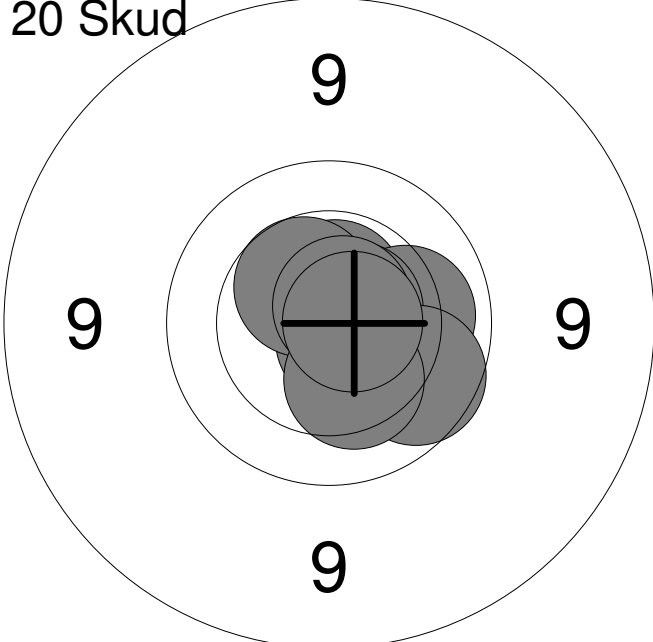
| | | | | | | | | | | | | | | | | | | | | | | | | | | | | | | | | | | | |
|---|--|----|-------|---|----|-------|---|----|------|---|----|------|---|----|-------|---|----|------|---|----|-----|---|----|-------|---|----|------|---|-----|-------|---|-------|------|-------|------|
| <p>20 Skud</p>  | <table style="width:100%; border-collapse: collapse;"> <tr><td style="text-align: right;">1:</td><td style="text-align: right;">*10.7</td><td style="text-align: right;">↘</td></tr> <tr><td style="text-align: right;">2:</td><td style="text-align: right;">*10.6</td><td style="text-align: right;">↗</td></tr> <tr><td style="text-align: right;">3:</td><td style="text-align: right;">10.2</td><td style="text-align: right;">→</td></tr> <tr><td style="text-align: right;">4:</td><td style="text-align: right;">10.1</td><td style="text-align: right;">→</td></tr> <tr><td style="text-align: right;">5:</td><td style="text-align: right;">*10.7</td><td style="text-align: right;">↗</td></tr> <tr><td style="text-align: right;">6:</td><td style="text-align: right;">10.5</td><td style="text-align: right;">↗</td></tr> <tr><td style="text-align: right;">7:</td><td style="text-align: right;">9.9</td><td style="text-align: right;">↘</td></tr> <tr><td style="text-align: right;">8:</td><td style="text-align: right;">*10.7</td><td style="text-align: right;">↗</td></tr> <tr><td style="text-align: right;">9:</td><td style="text-align: right;">10.3</td><td style="text-align: right;">↘</td></tr> <tr><td style="text-align: right;">10:</td><td style="text-align: right;">*10.7</td><td style="text-align: right;">→</td></tr> </table> <table border="1" style="width:100%; border-collapse: collapse; margin-top: 10px;"> <tr> <td style="width:80%;">Serie</td> <td style="text-align: right;">99.0</td> </tr> <tr> <td>Total</td> <td style="text-align: right;">99.0</td> </tr> </table> | 1: | *10.7 | ↘ | 2: | *10.6 | ↗ | 3: | 10.2 | → | 4: | 10.1 | → | 5: | *10.7 | ↗ | 6: | 10.5 | ↗ | 7: | 9.9 | ↘ | 8: | *10.7 | ↗ | 9: | 10.3 | ↘ | 10: | *10.7 | → | Serie | 99.0 | Total | 99.0 |
| 1: | *10.7 | ↘ | | | | | | | | | | | | | | | | | | | | | | | | | | | | | | | | | |
| 2: | *10.6 | ↗ | | | | | | | | | | | | | | | | | | | | | | | | | | | | | | | | | |
| 3: | 10.2 | → | | | | | | | | | | | | | | | | | | | | | | | | | | | | | | | | | |
| 4: | 10.1 | → | | | | | | | | | | | | | | | | | | | | | | | | | | | | | | | | | |
| 5: | *10.7 | ↗ | | | | | | | | | | | | | | | | | | | | | | | | | | | | | | | | | |
| 6: | 10.5 | ↗ | | | | | | | | | | | | | | | | | | | | | | | | | | | | | | | | | |
| 7: | 9.9 | ↘ | | | | | | | | | | | | | | | | | | | | | | | | | | | | | | | | | |
| 8: | *10.7 | ↗ | | | | | | | | | | | | | | | | | | | | | | | | | | | | | | | | | |
| 9: | 10.3 | ↘ | | | | | | | | | | | | | | | | | | | | | | | | | | | | | | | | | |
| 10: | *10.7 | → | | | | | | | | | | | | | | | | | | | | | | | | | | | | | | | | | |
| Serie | 99.0 | | | | | | | | | | | | | | | | | | | | | | | | | | | | | | | | | | |
| Total | 99.0 | | | | | | | | | | | | | | | | | | | | | | | | | | | | | | | | | | |

| | | | | | | | | | | | | | | | | | | | | | | | | | | | | | | | | | | | |
|--|---|-----|------|---|-----|-------|---|-----|-------|---|-----|------|---|-----|------|---|-----|------|---|-----|-------|---|-----|-----|---|-----|-------|---|-----|------|---|-------|------|-------|-------|
| <p>20 Skud</p>  | <table style="width:100%; border-collapse: collapse;"> <tr><td style="text-align: right;">11:</td><td style="text-align: right;">10.3</td><td style="text-align: right;">↘</td></tr> <tr><td style="text-align: right;">12:</td><td style="text-align: right;">*10.9</td><td style="text-align: right;">↘</td></tr> <tr><td style="text-align: right;">13:</td><td style="text-align: right;">*10.9</td><td style="text-align: right;">→</td></tr> <tr><td style="text-align: right;">14:</td><td style="text-align: right;">10.0</td><td style="text-align: right;">→</td></tr> <tr><td style="text-align: right;">15:</td><td style="text-align: right;">10.2</td><td style="text-align: right;">↘</td></tr> <tr><td style="text-align: right;">16:</td><td style="text-align: right;">10.4</td><td style="text-align: right;">↗</td></tr> <tr><td style="text-align: right;">17:</td><td style="text-align: right;">*10.9</td><td style="text-align: right;">←</td></tr> <tr><td style="text-align: right;">18:</td><td style="text-align: right;">9.9</td><td style="text-align: right;">→</td></tr> <tr><td style="text-align: right;">19:</td><td style="text-align: right;">*10.7</td><td style="text-align: right;">↘</td></tr> <tr><td style="text-align: right;">20:</td><td style="text-align: right;">10.1</td><td style="text-align: right;">←</td></tr> </table> <table border="1" style="width:100%; border-collapse: collapse; margin-top: 10px;"> <tr> <td style="width:80%;">Serie</td> <td style="text-align: right;">99.0</td> </tr> <tr> <td>Total</td> <td style="text-align: right;">198.0</td> </tr> </table> | 11: | 10.3 | ↘ | 12: | *10.9 | ↘ | 13: | *10.9 | → | 14: | 10.0 | → | 15: | 10.2 | ↘ | 16: | 10.4 | ↗ | 17: | *10.9 | ← | 18: | 9.9 | → | 19: | *10.7 | ↘ | 20: | 10.1 | ← | Serie | 99.0 | Total | 198.0 |
| 11: | 10.3 | ↘ | | | | | | | | | | | | | | | | | | | | | | | | | | | | | | | | | |
| 12: | *10.9 | ↘ | | | | | | | | | | | | | | | | | | | | | | | | | | | | | | | | | |
| 13: | *10.9 | → | | | | | | | | | | | | | | | | | | | | | | | | | | | | | | | | | |
| 14: | 10.0 | → | | | | | | | | | | | | | | | | | | | | | | | | | | | | | | | | | |
| 15: | 10.2 | ↘ | | | | | | | | | | | | | | | | | | | | | | | | | | | | | | | | | |
| 16: | 10.4 | ↗ | | | | | | | | | | | | | | | | | | | | | | | | | | | | | | | | | |
| 17: | *10.9 | ← | | | | | | | | | | | | | | | | | | | | | | | | | | | | | | | | | |
| 18: | 9.9 | → | | | | | | | | | | | | | | | | | | | | | | | | | | | | | | | | | |
| 19: | *10.7 | ↘ | | | | | | | | | | | | | | | | | | | | | | | | | | | | | | | | | |
| 20: | 10.1 | ← | | | | | | | | | | | | | | | | | | | | | | | | | | | | | | | | | |
| Serie | 99.0 | | | | | | | | | | | | | | | | | | | | | | | | | | | | | | | | | | |
| Total | 198.0 | | | | | | | | | | | | | | | | | | | | | | | | | | | | | | | | | | |

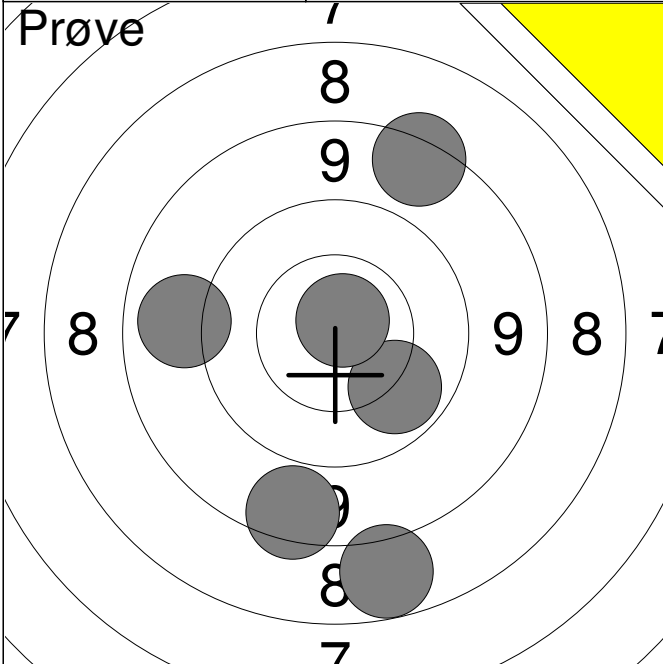
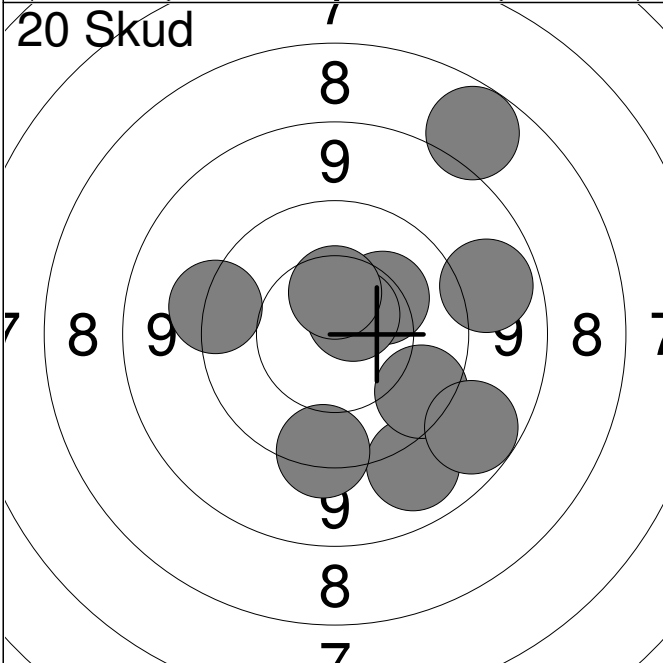
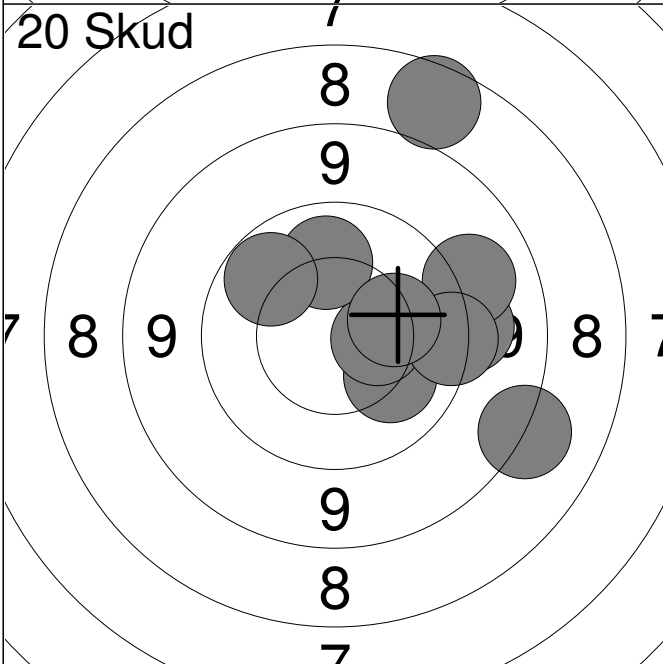
| | | | | | | | | | | | | | | | | | | | | | | | | | | | | | | | | | | | | | |
|--|--|-------|------|---|-----|------|---|-----|------|---|-----|-------|---|-----|------|---|-----|-------|---|-------|-----|------|-------|------|-----|-----|-----|---|-----|------|---|-------|--|------|-------|--|-------|
| <p>Prøve</p>  | <table style="width:100%; border-collapse: collapse;"> <tr><td style="width:10%;">1:</td><td style="width:15%;">8.7</td><td style="width:10%; text-align:right;">↓</td></tr> <tr><td>2:</td><td>8.0</td><td style="text-align:right;">↓</td></tr> <tr><td>3:</td><td>8.6</td><td style="text-align:right;">↗</td></tr> <tr><td>4:</td><td>9.1</td><td style="text-align:right;">←</td></tr> <tr><td>5:</td><td>10.0</td><td style="text-align:right;">↘</td></tr> <tr><td>6:</td><td>*10.8</td><td style="text-align:right;">↗</td></tr> <tr><td colspan="2">Serie</td><td style="text-align:right;">53.0</td></tr> <tr><td colspan="2">Total</td><td style="text-align:right;">0.0</td></tr> </table> | 1: | 8.7 | ↓ | 2: | 8.0 | ↓ | 3: | 8.6 | ↗ | 4: | 9.1 | ← | 5: | 10.0 | ↘ | 6: | *10.8 | ↗ | Serie | | 53.0 | Total | | 0.0 | | | | | | | | | | | | |
| 1: | 8.7 | ↓ | | | | | | | | | | | | | | | | | | | | | | | | | | | | | | | | | | | |
| 2: | 8.0 | ↓ | | | | | | | | | | | | | | | | | | | | | | | | | | | | | | | | | | | |
| 3: | 8.6 | ↗ | | | | | | | | | | | | | | | | | | | | | | | | | | | | | | | | | | | |
| 4: | 9.1 | ← | | | | | | | | | | | | | | | | | | | | | | | | | | | | | | | | | | | |
| 5: | 10.0 | ↘ | | | | | | | | | | | | | | | | | | | | | | | | | | | | | | | | | | | |
| 6: | *10.8 | ↗ | | | | | | | | | | | | | | | | | | | | | | | | | | | | | | | | | | | |
| Serie | | 53.0 | | | | | | | | | | | | | | | | | | | | | | | | | | | | | | | | | | | |
| Total | | 0.0 | | | | | | | | | | | | | | | | | | | | | | | | | | | | | | | | | | | |
| <p>20 Skud</p>  | <table style="width:100%; border-collapse: collapse;"> <tr><td style="width:10%;">1:</td><td style="width:15%;">9.1</td><td style="width:10%; text-align:right;">↓</td></tr> <tr><td>2:</td><td>9.7</td><td style="text-align:right;">↘</td></tr> <tr><td>3:</td><td>10.3</td><td style="text-align:right;">↗</td></tr> <tr><td>4:</td><td>*10.6</td><td style="text-align:right;">↗</td></tr> <tr><td>5:</td><td>9.6</td><td style="text-align:right;">↓</td></tr> <tr><td>6:</td><td>10.5</td><td style="text-align:right;">↑</td></tr> <tr><td>7:</td><td>9.0</td><td style="text-align:right;">↘</td></tr> <tr><td>8:</td><td>8.0</td><td style="text-align:right;">↗</td></tr> <tr><td>9:</td><td>9.0</td><td style="text-align:right;">→</td></tr> <tr><td>10:</td><td>9.5</td><td style="text-align:right;">←</td></tr> <tr><td colspan="2">Serie</td><td style="text-align:right;">92.0</td></tr> <tr><td colspan="2">Total</td><td style="text-align:right;">92.0</td></tr> </table> | 1: | 9.1 | ↓ | 2: | 9.7 | ↘ | 3: | 10.3 | ↗ | 4: | *10.6 | ↗ | 5: | 9.6 | ↓ | 6: | 10.5 | ↑ | 7: | 9.0 | ↘ | 8: | 8.0 | ↗ | 9: | 9.0 | → | 10: | 9.5 | ← | Serie | | 92.0 | Total | | 92.0 |
| 1: | 9.1 | ↓ | | | | | | | | | | | | | | | | | | | | | | | | | | | | | | | | | | | |
| 2: | 9.7 | ↘ | | | | | | | | | | | | | | | | | | | | | | | | | | | | | | | | | | | |
| 3: | 10.3 | ↗ | | | | | | | | | | | | | | | | | | | | | | | | | | | | | | | | | | | |
| 4: | *10.6 | ↗ | | | | | | | | | | | | | | | | | | | | | | | | | | | | | | | | | | | |
| 5: | 9.6 | ↓ | | | | | | | | | | | | | | | | | | | | | | | | | | | | | | | | | | | |
| 6: | 10.5 | ↑ | | | | | | | | | | | | | | | | | | | | | | | | | | | | | | | | | | | |
| 7: | 9.0 | ↘ | | | | | | | | | | | | | | | | | | | | | | | | | | | | | | | | | | | |
| 8: | 8.0 | ↗ | | | | | | | | | | | | | | | | | | | | | | | | | | | | | | | | | | | |
| 9: | 9.0 | → | | | | | | | | | | | | | | | | | | | | | | | | | | | | | | | | | | | |
| 10: | 9.5 | ← | | | | | | | | | | | | | | | | | | | | | | | | | | | | | | | | | | | |
| Serie | | 92.0 | | | | | | | | | | | | | | | | | | | | | | | | | | | | | | | | | | | |
| Total | | 92.0 | | | | | | | | | | | | | | | | | | | | | | | | | | | | | | | | | | | |
| <p>20 Skud</p>  | <table style="width:100%; border-collapse: collapse;"> <tr><td style="width:10%;">11:</td><td style="width:15%;">10.2</td><td style="width:10%; text-align:right;">↘</td></tr> <tr><td>12:</td><td>10.5</td><td style="text-align:right;">→</td></tr> <tr><td>13:</td><td>7.8</td><td style="text-align:right;">↗</td></tr> <tr><td>14:</td><td>9.4</td><td style="text-align:right;">→</td></tr> <tr><td>15:</td><td>9.2</td><td style="text-align:right;">↗</td></tr> <tr><td>16:</td><td>10.1</td><td style="text-align:right;">↑</td></tr> <tr><td>17:</td><td>8.3</td><td style="text-align:right;">↘</td></tr> <tr><td>18:</td><td>10.0</td><td style="text-align:right;">↗</td></tr> <tr><td>19:</td><td>9.6</td><td style="text-align:right;">→</td></tr> <tr><td>20:</td><td>10.2</td><td style="text-align:right;">→</td></tr> <tr><td colspan="2">Serie</td><td style="text-align:right;">92.0</td></tr> <tr><td colspan="2">Total</td><td style="text-align:right;">184.0</td></tr> </table> | 11: | 10.2 | ↘ | 12: | 10.5 | → | 13: | 7.8 | ↗ | 14: | 9.4 | → | 15: | 9.2 | ↗ | 16: | 10.1 | ↑ | 17: | 8.3 | ↘ | 18: | 10.0 | ↗ | 19: | 9.6 | → | 20: | 10.2 | → | Serie | | 92.0 | Total | | 184.0 |
| 11: | 10.2 | ↘ | | | | | | | | | | | | | | | | | | | | | | | | | | | | | | | | | | | |
| 12: | 10.5 | → | | | | | | | | | | | | | | | | | | | | | | | | | | | | | | | | | | | |
| 13: | 7.8 | ↗ | | | | | | | | | | | | | | | | | | | | | | | | | | | | | | | | | | | |
| 14: | 9.4 | → | | | | | | | | | | | | | | | | | | | | | | | | | | | | | | | | | | | |
| 15: | 9.2 | ↗ | | | | | | | | | | | | | | | | | | | | | | | | | | | | | | | | | | | |
| 16: | 10.1 | ↑ | | | | | | | | | | | | | | | | | | | | | | | | | | | | | | | | | | | |
| 17: | 8.3 | ↘ | | | | | | | | | | | | | | | | | | | | | | | | | | | | | | | | | | | |
| 18: | 10.0 | ↗ | | | | | | | | | | | | | | | | | | | | | | | | | | | | | | | | | | | |
| 19: | 9.6 | → | | | | | | | | | | | | | | | | | | | | | | | | | | | | | | | | | | | |
| 20: | 10.2 | → | | | | | | | | | | | | | | | | | | | | | | | | | | | | | | | | | | | |
| Serie | | 92.0 | | | | | | | | | | | | | | | | | | | | | | | | | | | | | | | | | | | |
| Total | | 184.0 | | | | | | | | | | | | | | | | | | | | | | | | | | | | | | | | | | | |

| | | | | | | | | | | | | | | | | | | | | | | | | | | | | | | | | | | | | | |
|---------------------|---|------|-------|---|----|-----|---|----|------|---|----|------|---|----|------|---|----|------|---|----|------|---|----|------|---|----|-------|---|-----|-------|---|-------|--|------|-------|--|-----|
| <p>Prøve</p> | <table style="width:100%; border-collapse: collapse;"> <tr><td style="text-align: right;">1:</td><td style="text-align: right;">*10.8</td><td style="text-align: right;">←</td></tr> <tr><td style="text-align: right;">2:</td><td style="text-align: right;">9.8</td><td style="text-align: right;">↘</td></tr> <tr><td style="text-align: right;">3:</td><td style="text-align: right;">10.0</td><td style="text-align: right;">→</td></tr> <tr><td style="text-align: right;">4:</td><td style="text-align: right;">10.2</td><td style="text-align: right;">↙</td></tr> <tr><td style="text-align: right;">5:</td><td style="text-align: right;">10.3</td><td style="text-align: right;">→</td></tr> <tr><td style="text-align: right;">6:</td><td style="text-align: right;">10.3</td><td style="text-align: right;">↗</td></tr> <tr><td style="text-align: right;">7:</td><td style="text-align: right;">10.0</td><td style="text-align: right;">↑</td></tr> <tr><td style="text-align: right;">8:</td><td style="text-align: right;">10.3</td><td style="text-align: right;">↗</td></tr> <tr><td style="text-align: right;">9:</td><td style="text-align: right;">*10.8</td><td style="text-align: right;">↘</td></tr> <tr><td style="text-align: right;">10:</td><td style="text-align: right;">*10.5</td><td style="text-align: right;">↘</td></tr> <tr><td colspan="2">Serie</td><td style="text-align: right;">99.0</td></tr> <tr><td colspan="2">Total</td><td style="text-align: right;">0.0</td></tr> </table> | 1: | *10.8 | ← | 2: | 9.8 | ↘ | 3: | 10.0 | → | 4: | 10.2 | ↙ | 5: | 10.3 | → | 6: | 10.3 | ↗ | 7: | 10.0 | ↑ | 8: | 10.3 | ↗ | 9: | *10.8 | ↘ | 10: | *10.5 | ↘ | Serie | | 99.0 | Total | | 0.0 |
| 1: | *10.8 | ← | | | | | | | | | | | | | | | | | | | | | | | | | | | | | | | | | | | |
| 2: | 9.8 | ↘ | | | | | | | | | | | | | | | | | | | | | | | | | | | | | | | | | | | |
| 3: | 10.0 | → | | | | | | | | | | | | | | | | | | | | | | | | | | | | | | | | | | | |
| 4: | 10.2 | ↙ | | | | | | | | | | | | | | | | | | | | | | | | | | | | | | | | | | | |
| 5: | 10.3 | → | | | | | | | | | | | | | | | | | | | | | | | | | | | | | | | | | | | |
| 6: | 10.3 | ↗ | | | | | | | | | | | | | | | | | | | | | | | | | | | | | | | | | | | |
| 7: | 10.0 | ↑ | | | | | | | | | | | | | | | | | | | | | | | | | | | | | | | | | | | |
| 8: | 10.3 | ↗ | | | | | | | | | | | | | | | | | | | | | | | | | | | | | | | | | | | |
| 9: | *10.8 | ↘ | | | | | | | | | | | | | | | | | | | | | | | | | | | | | | | | | | | |
| 10: | *10.5 | ↘ | | | | | | | | | | | | | | | | | | | | | | | | | | | | | | | | | | | |
| Serie | | 99.0 | | | | | | | | | | | | | | | | | | | | | | | | | | | | | | | | | | | |
| Total | | 0.0 | | | | | | | | | | | | | | | | | | | | | | | | | | | | | | | | | | | |

| | | | | | | | | | | | | | | | | | | | | | | | | | | | | | | | | | | | | | |
|-----------------------|---|------|------|---|----|-------|---|----|-------|---|----|-----|---|----|-------|---|----|-----|---|----|------|---|----|------|---|----|-------|---|-----|-----|---|-------|--|------|-------|--|------|
| <p>20 Skud</p> | <table style="width:100%; border-collapse: collapse;"> <tr><td style="text-align: right;">1:</td><td style="text-align: right;">10.4</td><td style="text-align: right;">↘</td></tr> <tr><td style="text-align: right;">2:</td><td style="text-align: right;">*10.7</td><td style="text-align: right;">↘</td></tr> <tr><td style="text-align: right;">3:</td><td style="text-align: right;">*10.5</td><td style="text-align: right;">↗</td></tr> <tr><td style="text-align: right;">4:</td><td style="text-align: right;">9.9</td><td style="text-align: right;">↘</td></tr> <tr><td style="text-align: right;">5:</td><td style="text-align: right;">*10.5</td><td style="text-align: right;">↘</td></tr> <tr><td style="text-align: right;">6:</td><td style="text-align: right;">9.7</td><td style="text-align: right;">↙</td></tr> <tr><td style="text-align: right;">7:</td><td style="text-align: right;">10.4</td><td style="text-align: right;">↘</td></tr> <tr><td style="text-align: right;">8:</td><td style="text-align: right;">10.0</td><td style="text-align: right;">↗</td></tr> <tr><td style="text-align: right;">9:</td><td style="text-align: right;">*10.7</td><td style="text-align: right;">↙</td></tr> <tr><td style="text-align: right;">10:</td><td style="text-align: right;">9.7</td><td style="text-align: right;">→</td></tr> <tr><td colspan="2">Serie</td><td style="text-align: right;">97.0</td></tr> <tr><td colspan="2">Total</td><td style="text-align: right;">97.0</td></tr> </table> | 1: | 10.4 | ↘ | 2: | *10.7 | ↘ | 3: | *10.5 | ↗ | 4: | 9.9 | ↘ | 5: | *10.5 | ↘ | 6: | 9.7 | ↙ | 7: | 10.4 | ↘ | 8: | 10.0 | ↗ | 9: | *10.7 | ↙ | 10: | 9.7 | → | Serie | | 97.0 | Total | | 97.0 |
| 1: | 10.4 | ↘ | | | | | | | | | | | | | | | | | | | | | | | | | | | | | | | | | | | |
| 2: | *10.7 | ↘ | | | | | | | | | | | | | | | | | | | | | | | | | | | | | | | | | | | |
| 3: | *10.5 | ↗ | | | | | | | | | | | | | | | | | | | | | | | | | | | | | | | | | | | |
| 4: | 9.9 | ↘ | | | | | | | | | | | | | | | | | | | | | | | | | | | | | | | | | | | |
| 5: | *10.5 | ↘ | | | | | | | | | | | | | | | | | | | | | | | | | | | | | | | | | | | |
| 6: | 9.7 | ↙ | | | | | | | | | | | | | | | | | | | | | | | | | | | | | | | | | | | |
| 7: | 10.4 | ↘ | | | | | | | | | | | | | | | | | | | | | | | | | | | | | | | | | | | |
| 8: | 10.0 | ↗ | | | | | | | | | | | | | | | | | | | | | | | | | | | | | | | | | | | |
| 9: | *10.7 | ↙ | | | | | | | | | | | | | | | | | | | | | | | | | | | | | | | | | | | |
| 10: | 9.7 | → | | | | | | | | | | | | | | | | | | | | | | | | | | | | | | | | | | | |
| Serie | | 97.0 | | | | | | | | | | | | | | | | | | | | | | | | | | | | | | | | | | | |
| Total | | 97.0 | | | | | | | | | | | | | | | | | | | | | | | | | | | | | | | | | | | |

| | | | | | | | | | | | | | | | | | | | | | | | | | | | | | | | | | | | | | |
|-----------------------|--|-------|------|---|-----|------|---|-----|------|---|-----|-------|---|-----|------|---|-----|------|---|-----|------|---|-----|------|---|-----|------|---|-----|-----|---|-------|--|------|-------|--|-------|
| <p>20 Skud</p> | <table style="width:100%; border-collapse: collapse;"> <tr><td style="text-align: right;">11:</td><td style="text-align: right;">10.1</td><td style="text-align: right;">↘</td></tr> <tr><td style="text-align: right;">12:</td><td style="text-align: right;">10.3</td><td style="text-align: right;">↗</td></tr> <tr><td style="text-align: right;">13:</td><td style="text-align: right;">10.1</td><td style="text-align: right;">←</td></tr> <tr><td style="text-align: right;">14:</td><td style="text-align: right;">*10.5</td><td style="text-align: right;">→</td></tr> <tr><td style="text-align: right;">15:</td><td style="text-align: right;">10.2</td><td style="text-align: right;">↘</td></tr> <tr><td style="text-align: right;">16:</td><td style="text-align: right;">10.2</td><td style="text-align: right;">↘</td></tr> <tr><td style="text-align: right;">17:</td><td style="text-align: right;">10.1</td><td style="text-align: right;">↙</td></tr> <tr><td style="text-align: right;">18:</td><td style="text-align: right;">10.4</td><td style="text-align: right;">↘</td></tr> <tr><td style="text-align: right;">19:</td><td style="text-align: right;">10.3</td><td style="text-align: right;">↗</td></tr> <tr><td style="text-align: right;">20:</td><td style="text-align: right;">9.9</td><td style="text-align: right;">↘</td></tr> <tr><td colspan="2">Serie</td><td style="text-align: right;">99.0</td></tr> <tr><td colspan="2">Total</td><td style="text-align: right;">196.0</td></tr> </table> | 11: | 10.1 | ↘ | 12: | 10.3 | ↗ | 13: | 10.1 | ← | 14: | *10.5 | → | 15: | 10.2 | ↘ | 16: | 10.2 | ↘ | 17: | 10.1 | ↙ | 18: | 10.4 | ↘ | 19: | 10.3 | ↗ | 20: | 9.9 | ↘ | Serie | | 99.0 | Total | | 196.0 |
| 11: | 10.1 | ↘ | | | | | | | | | | | | | | | | | | | | | | | | | | | | | | | | | | | |
| 12: | 10.3 | ↗ | | | | | | | | | | | | | | | | | | | | | | | | | | | | | | | | | | | |
| 13: | 10.1 | ← | | | | | | | | | | | | | | | | | | | | | | | | | | | | | | | | | | | |
| 14: | *10.5 | → | | | | | | | | | | | | | | | | | | | | | | | | | | | | | | | | | | | |
| 15: | 10.2 | ↘ | | | | | | | | | | | | | | | | | | | | | | | | | | | | | | | | | | | |
| 16: | 10.2 | ↘ | | | | | | | | | | | | | | | | | | | | | | | | | | | | | | | | | | | |
| 17: | 10.1 | ↙ | | | | | | | | | | | | | | | | | | | | | | | | | | | | | | | | | | | |
| 18: | 10.4 | ↘ | | | | | | | | | | | | | | | | | | | | | | | | | | | | | | | | | | | |
| 19: | 10.3 | ↗ | | | | | | | | | | | | | | | | | | | | | | | | | | | | | | | | | | | |
| 20: | 9.9 | ↘ | | | | | | | | | | | | | | | | | | | | | | | | | | | | | | | | | | | |
| Serie | | 99.0 | | | | | | | | | | | | | | | | | | | | | | | | | | | | | | | | | | | |
| Total | | 196.0 | | | | | | | | | | | | | | | | | | | | | | | | | | | | | | | | | | | |

| | | | | | | | | | | | | | | | | | | | |
|---|--|-------|-------|------|-------|-----|-----|----|------|---|----|-----|---|----|-------|---|----|------|---|
| <p>Prøve</p> | <table style="width:100%; border-collapse: collapse;"> <tr><td style="width:10%;">1:</td><td style="width:80%;">*10.6</td><td style="width:10%; text-align: center;">→</td></tr> <tr><td>2:</td><td>9.9</td><td style="text-align: center;">↓</td></tr> <tr><td>3:</td><td>10.0</td><td style="text-align: center;">↑</td></tr> <tr><td>4:</td><td>9.8</td><td style="text-align: center;">↓</td></tr> <tr><td>5:</td><td>*10.6</td><td style="text-align: center;">↑</td></tr> <tr><td>6:</td><td>10.2</td><td style="text-align: center;">↑</td></tr> </table> | 1: | *10.6 | → | 2: | 9.9 | ↓ | 3: | 10.0 | ↑ | 4: | 9.8 | ↓ | 5: | *10.6 | ↑ | 6: | 10.2 | ↑ |
| 1: | *10.6 | → | | | | | | | | | | | | | | | | | |
| 2: | 9.9 | ↓ | | | | | | | | | | | | | | | | | |
| 3: | 10.0 | ↑ | | | | | | | | | | | | | | | | | |
| 4: | 9.8 | ↓ | | | | | | | | | | | | | | | | | |
| 5: | *10.6 | ↑ | | | | | | | | | | | | | | | | | |
| 6: | 10.2 | ↑ | | | | | | | | | | | | | | | | | |
| <table style="width:100%; border-collapse: collapse;"> <tr> <td style="width:10%;">Serie</td> <td style="width:80%;"></td> <td style="width:10%; text-align: right;">58.0</td> </tr> <tr> <td>Total</td> <td></td> <td style="text-align: right;">0.0</td> </tr> </table> | | Serie | | 58.0 | Total | | 0.0 | | | | | | | | | | | | |
| Serie | | 58.0 | | | | | | | | | | | | | | | | | |
| Total | | 0.0 | | | | | | | | | | | | | | | | | |

| | | | | | | | | | | | | | | | | | | | | | | | | | | | | | | | |
|--|--|-------|------|------|-------|-----|------|----|-------|---|----|-------|---|----|------|---|----|-----|---|----|-------|---|----|------|---|----|------|---|-----|------|---|
| <p>20 Skud</p> | <table style="width:100%; border-collapse: collapse;"> <tr><td style="width:10%;">1:</td><td style="width:80%;">10.2</td><td style="width:10%; text-align: center;">↓</td></tr> <tr><td>2:</td><td>9.2</td><td style="text-align: center;">↑</td></tr> <tr><td>3:</td><td>*10.7</td><td style="text-align: center;">↓</td></tr> <tr><td>4:</td><td>*10.8</td><td style="text-align: center;">←</td></tr> <tr><td>5:</td><td>10.0</td><td style="text-align: center;">↓</td></tr> <tr><td>6:</td><td>9.8</td><td style="text-align: center;">↑</td></tr> <tr><td>7:</td><td>*10.7</td><td style="text-align: center;">↓</td></tr> <tr><td>8:</td><td>10.5</td><td style="text-align: center;">↑</td></tr> <tr><td>9:</td><td>10.3</td><td style="text-align: center;">↓</td></tr> <tr><td>10:</td><td>10.1</td><td style="text-align: center;">↓</td></tr> </table> | 1: | 10.2 | ↓ | 2: | 9.2 | ↑ | 3: | *10.7 | ↓ | 4: | *10.8 | ← | 5: | 10.0 | ↓ | 6: | 9.8 | ↑ | 7: | *10.7 | ↓ | 8: | 10.5 | ↑ | 9: | 10.3 | ↓ | 10: | 10.1 | ↓ |
| 1: | 10.2 | ↓ | | | | | | | | | | | | | | | | | | | | | | | | | | | | | |
| 2: | 9.2 | ↑ | | | | | | | | | | | | | | | | | | | | | | | | | | | | | |
| 3: | *10.7 | ↓ | | | | | | | | | | | | | | | | | | | | | | | | | | | | | |
| 4: | *10.8 | ← | | | | | | | | | | | | | | | | | | | | | | | | | | | | | |
| 5: | 10.0 | ↓ | | | | | | | | | | | | | | | | | | | | | | | | | | | | | |
| 6: | 9.8 | ↑ | | | | | | | | | | | | | | | | | | | | | | | | | | | | | |
| 7: | *10.7 | ↓ | | | | | | | | | | | | | | | | | | | | | | | | | | | | | |
| 8: | 10.5 | ↑ | | | | | | | | | | | | | | | | | | | | | | | | | | | | | |
| 9: | 10.3 | ↓ | | | | | | | | | | | | | | | | | | | | | | | | | | | | | |
| 10: | 10.1 | ↓ | | | | | | | | | | | | | | | | | | | | | | | | | | | | | |
| <table style="width:100%; border-collapse: collapse;"> <tr> <td style="width:10%;">Serie</td> <td style="width:80%;"></td> <td style="width:10%; text-align: right;">98.0</td> </tr> <tr> <td>Total</td> <td></td> <td style="text-align: right;">98.0</td> </tr> </table> | | Serie | | 98.0 | Total | | 98.0 | | | | | | | | | | | | | | | | | | | | | | | | |
| Serie | | 98.0 | | | | | | | | | | | | | | | | | | | | | | | | | | | | | |
| Total | | 98.0 | | | | | | | | | | | | | | | | | | | | | | | | | | | | | |

| | | | | | | | | | | | | | | | | | | | | | | | | | | | | | | | |
|---|---|-------|-----|------|-------|------|-------|-----|-----|---|-----|------|---|-----|-----|---|-----|------|---|-----|-------|---|-----|------|---|-----|------|---|-----|-----|---|
| <p>20 Skud</p> | <table style="width:100%; border-collapse: collapse;"> <tr><td style="width:10%;">11:</td><td style="width:80%;">9.8</td><td style="width:10%; text-align: center;">←</td></tr> <tr><td>12:</td><td>10.0</td><td style="text-align: center;">↑</td></tr> <tr><td>13:</td><td>9.3</td><td style="text-align: center;">↓</td></tr> <tr><td>14:</td><td>10.3</td><td style="text-align: center;">↑</td></tr> <tr><td>15:</td><td>8.0</td><td style="text-align: center;">↓</td></tr> <tr><td>16:</td><td>10.1</td><td style="text-align: center;">↓</td></tr> <tr><td>17:</td><td>*10.6</td><td style="text-align: center;">↓</td></tr> <tr><td>18:</td><td>10.2</td><td style="text-align: center;">↑</td></tr> <tr><td>19:</td><td>10.4</td><td style="text-align: center;">↓</td></tr> <tr><td>20:</td><td>9.1</td><td style="text-align: center;">←</td></tr> </table> | 11: | 9.8 | ← | 12: | 10.0 | ↑ | 13: | 9.3 | ↓ | 14: | 10.3 | ↑ | 15: | 8.0 | ↓ | 16: | 10.1 | ↓ | 17: | *10.6 | ↓ | 18: | 10.2 | ↑ | 19: | 10.4 | ↓ | 20: | 9.1 | ← |
| 11: | 9.8 | ← | | | | | | | | | | | | | | | | | | | | | | | | | | | | | |
| 12: | 10.0 | ↑ | | | | | | | | | | | | | | | | | | | | | | | | | | | | | |
| 13: | 9.3 | ↓ | | | | | | | | | | | | | | | | | | | | | | | | | | | | | |
| 14: | 10.3 | ↑ | | | | | | | | | | | | | | | | | | | | | | | | | | | | | |
| 15: | 8.0 | ↓ | | | | | | | | | | | | | | | | | | | | | | | | | | | | | |
| 16: | 10.1 | ↓ | | | | | | | | | | | | | | | | | | | | | | | | | | | | | |
| 17: | *10.6 | ↓ | | | | | | | | | | | | | | | | | | | | | | | | | | | | | |
| 18: | 10.2 | ↑ | | | | | | | | | | | | | | | | | | | | | | | | | | | | | |
| 19: | 10.4 | ↓ | | | | | | | | | | | | | | | | | | | | | | | | | | | | | |
| 20: | 9.1 | ← | | | | | | | | | | | | | | | | | | | | | | | | | | | | | |
| <table style="width:100%; border-collapse: collapse;"> <tr> <td style="width:10%;">Serie</td> <td style="width:80%;"></td> <td style="width:10%; text-align: right;">95.0</td> </tr> <tr> <td>Total</td> <td></td> <td style="text-align: right;">193.0</td> </tr> </table> | | Serie | | 95.0 | Total | | 193.0 | | | | | | | | | | | | | | | | | | | | | | | | |
| Serie | | 95.0 | | | | | | | | | | | | | | | | | | | | | | | | | | | | | |
| Total | | 193.0 | | | | | | | | | | | | | | | | | | | | | | | | | | | | | |